

Product brochure

Edition 2018



So that safety is guaranteed in your system



0799 (System 2+)

The CE labelling of the wedi products documents their tested and approved use as a sealing system for wet rooms.



Systems from wedi are labelled with the French VOC classification. A+ stands for exceptionally low emission, non-hazardous product systems.



The wedi product systems satisfy the construction guidelines and regulations that are valid in England, Wales, Northern Ireland and Scotland.



The system solutions from wedi have a wide range of differing technical building approvals and test certificates.



With the silver Architects' Darling award in 2013, wedi was honoured as one of the most popular German manufacturers in the construction sector.



The barrier-free wedi products have been tested, assessed and certified for their conformity by the DIN CERTCO organisation for conformity assessments.



The wedi product systems have been technically tested and labelled in France by the CSTB (Centre scientifique et technique du bâtiment).



When manufacturing its products, wedi uses certified green electricity from renewable energies.



The wedi construction systems are labelled with the leading Finnish emissions classification. In this context, M1 stands for the highest quality.



The Norwegian test seal, which corresponds to the European requirements, certifies the high technical quality of the wedi product systems.



The wedi quality management and the high product quality are labelled with the Finnish VTT test seal.



The MK test seal qualifies wedi products for use in Denmark in accordance with the country-specific guidelines, norms and standards.

Contact wedi Headquarters

Telephone +49 2572 156-0
E-Mail info@wedi.de

Contact wedi Sales Germany

Fax +49 2572 156-133
E-Mail sales@wedi.de

Contact Spa & wellness

Fax +49 2572 156-239
E-Mail project@wedi.de

Building boards

- 01 Building boards and finished elements
- 02 Partition wall systems
- 03 Installation materials & sealing

Floor-level showers

- 04 Ready-to-use surface for Fundo shower systems
- 05 Point drainage
- 06 Wooden floor solutions
- 07 Drain grates
- 08 Linear drainage
- 09 Complete systems
- 10 Installation materials & sealing
- 11 Sound insulation & decoupling

Wellness

- 12 Finished elements
- 13 Spa and wellness projects
- 14 Technical information





The **10-year quality guarantee** on the entire range

With the extended guarantee on all products and systems, wedi is setting new standards when it comes to quality leadership. You can find all the relevant information about the new guarantees and the corresponding conditions at: www.wedi.eu



Contents

Building boards

Page 8 Building boards and finished elements

- 10 wedi building board
- 10 wedi building board XL & XXL
- 11 wedi building board Vapor, with pre-installed vapour barrier
- 11 wedi building board Construct, lengthwise and widthwise
- 12 wedi Mensolo-L, angle unit
- 12 wedi Mensolo-U, angle unit
- 12 wedi Bathboard, bath cladding
- 12 wedi Bathboard Shower, shower tray cladding
- 13 wedi Shower-Kits
- 13 wedi I-Board, WC installation systems cover

Page 14 Partition wall systems

- 16 wedi Moltoromo, wall segments straight
- 16 wedi Moltoromo, angled wall segment
- 16 wedi Moltoromo, wall segments curved
- 17 wedi Moltoromo, straight duct segment
- 17 wedi Moltoromo, angled duct segment
- 17 wedi Moltoromo, supply segments curved
- 18 wedi Moltoromo, corner profile
- 18 wedi Moltoromo, centered end profile
- 18 wedi Moltoromo, lateral end profile
- 19 wedi Moltoromo, installation set
- 19 wedi Moltoromo, wall / door fixing set

Page 20 Installation materials & sealing

- 22 wedi 610, adhesive sealant
- 22 wedi 520, Flexible sealants
- 22 wedi edge insulation strips
- 22 wedi Tools, joint reinforcement tape
- 22 wedi Tools, joint reinforcement tape, self-adhesive
- 23 wedi Fundo sealing set
- 23 wedi Tools, sealing tape, fleece laminated
- 23 wedi Tools, corners, fleece laminated
- 23 wedi Tools, sealing gaiter
- 24 wedi Tools, butyl bathtub sealing tape
- 24 wedi Subliner Dry, sealing membrane
- 24 wedi Subliner Dry & Flex, sealing and decoupling membrane
- 24 wedi protective covering fabric
- 25 wedi Tools, connector 90°
- 25 wedi Tools, wall connector
- 25 wedi Tools, connector 180°
- 26 wedi Tools, metal dowels
- 26 wedi Tools, washer
- 27 wedi Tools, fixings set
- 27 wedi Tools, cavity dowels set

Floor-level showers

Page 28 Ready-to-use surface for Fundo shower systems

- 30 Fundo Top Primo, ready-to-use surface
- 32 Fundo Top Plano, ready-to-use surface
- 34 Fundo Top Riolito neo, ready-to-use surface
- 35 Fundo Top Inlay, channel cover tileable
- 35 Fundo Top cladding
- 36 Fundo Top, ready-to-use surface, product overview

Page 38 Point drainage

- 40 Fundo Primo, floor elements
- 42 wedi Fundo special floor elements, point drainage
- 42 wedi sloping board, Fundo Primo
- 43 Fundo Borgo, floor element
- 43 Fundo Trollo, floor element
- 43 Fundo Trollo, wall element
- 44 Fundo Trollo libero, wall element
- 44 Fundo Trollo / Trollo libero, Glass doors
- 44 Fundo Nautilo, floor elements
- 45 Fundo Nautilo, wall element
- 45 Fundo Nautilo libero, wall element
- 45 wedi Fundo vertical drain, DN 50
- 46 wedi Fundo vertical drain, DN 50, round
- 46 wedi Fundo vertical drain, DN 50 with fire protection collar
- 46 wedi Fundo vertical drain, DN 70
- 47 wedi Fundo horizontal drain, DN 50
- 47 wedi Fundo horizontal drain, DN 50, round
- 47 wedi Fundo drain Mini Max, DN 40, extra flat
- 48 Fundo Primo Easy Set, substructure element, square
- 48 Fundo Primo Easy Set, substructure element, rectangular
- 48 wedi Fundo substrate elements, point drainage
- 48 wedi Shower-Kits

Page 50 Wooden floor solutions

- 52 Fundo Ligno, floor elements
- 53 Fundo Ligno special floor elements
- 53 Fundo Ligno, substructure element
- 54 wedi Fundo vertical drain, DN 50
- 54 wedi Fundo vertical drain, DN 50, round
- 54 wedi Fundo vertical drain, DN 70
- 55 wedi Fundo horizontal drain, DN 50
- 55 wedi Fundo horizontal drain, DN 50, round
- 55 wedi Fundo drain Mini Max, DN 40, extra flat

Page 56 Drain grates

- 58 Fundo Fino 1.1, drain grid, stainless steel
- 58 Fundo Fino 1.2, drain grid, stainless steel, round
- 58 Fundo Fino 1.3, drain grid, stainless steel, screw in
- 58 Fundo Fino 2.1, drain grid, stainless steel
- 58 Fundo Fino 2.2, drain grid, stainless steel, round
- 59 Fundo Fino 2.3, drain grid, stainless steel, screw in
- 59 Fundo Fino 3.1, drain grid, stainless steel
- 59 Fundo Fino 3.2, drain grid, stainless steel, round
- 59 Fundo Fino 3.3, drain grid, stainless steel, screw in
- 59 Fundo Fino 4.1, drain grid, solid stainless steel
- 60 Fundo Fino 4.2, drain grid, stainless steel, round
- 60 Fundo Fino 5.1, drain grid, solid stainless steel
- 60 Fundo Fino 6.1, drain grid, solid stainless steel
- 61 Fundo Fino, frame, stainless steel
- 61 Fundo Fino, frame, stainless steel, extra flat
- 61 Fundo Fino, frame, stainless steel, round
- 61 Fundo Fino, frame, stainless steel, round, extra flat

Page	62 Linear drainage
64	Fundo Riolito, floor elements
65	Fundo Riolito slope wedge, stainless steel V ₂ A
67	Fundo Riolito slope profile wall, stainless steel V ₂ A
69	Fundo Riolito neo, floor elements
70	Fundo Riolito neo / Plano Linea slope wedge, stainless steel V ₂ A
72	Fundo Riolito neo / Plano Linea slope profile wall, stainless steel V ₂ A
74	Fundo Riolito neo / Plano Linea end profile, stainless steel V ₂ A
74	Fundo Riofino, floor element with linear drainage
75	wedi Fundo special floor elements, linear drainage
77	wedi Fundo channel drain, vertical, DN 50
77	wedi Fundo channel drain, vertical, DN 50 with fire protection collar
77	wedi Fundo channel drain, horizontal, DN 50
78	wedi Fundo channel drain, DN 40, extra flat
78	wedi Fundo channel cover standard, stainless steel
79	wedi Fundo channel cover exclusive, solid stainless steel
79	wedi Fundo channel cover tileable, stainless steel
80	Fundo Discreto, attachment element
80	wedi sloping board, Fundo Riolito / Riolito neo / Riofino
Page	82 Complete systems
84	Fundo Integro, Standard-compliant complete system
85	Fundo Plano, floor elements with point drainage
86	Fundo Plano Linea, floor elements with channel
87	wedi Fundo channel cover exclusive, solid stainless steel
87	Fundo Discreto, attachment element
88	Fundo Riolito neo / Plano Linea slope wedge, stainless steel V ₂ A
90	Fundo Riolito neo / Plano Linea slope profile wall, stainless steel V ₂ A
92	Fundo Riolito neo / Plano Linea end profile, stainless steel V ₂ A
92	Fundo Integro / Plano / Plano Linea special floor elements
Page	94 Installation materials & sealing
96	wedi 610, adhesive sealant
96	wedi 520, Flexible sealants
96	wedi edge insulation strips
96	wedi Tools, joint reinforcement tape
96	wedi Tools, joint reinforcement tape, self-adhesive
97	wedi Fundo sealing set
97	wedi Tools, sealing tape, fleece laminated
97	wedi Tools, corners, fleece laminated
97	wedi Tools, sealing gaiter
98	wedi Tools, butyl bathtub sealing tape
98	wedi Subliner Dry, sealing membrane
98	wedi Subliner Dry & Flex, sealing and decoupling membrane
98	wedi protective covering fabric
99	wedi Tools, connector 90°
99	wedi Tools, wall connector

99	wedi Tools, connector 180°
100	wedi Tools, fixings set
100	wedi Tools, cavity dowels set

Page	102 Sound insulation & decoupling
104	wedi Nonstep Plan, sound insulation mat
104	wedi Nonstep Plus, sound insulation composite panel
104	wedi Nonstep Pro, sound insulation mat
104	wedi edge insulation strips
105	wedi Subliner Flex, decoupling membrane
105	wedi Subliner Dry & Flex, sealing and decoupling membrane

Wellness

Page	106 Finished elements
108	wedi Sanoasa benches 1 – 4
109	wedi Sanoasa corner seat element
109	wedi Sanwell wall element
109	wedi Sanwell Niches
110	wedi Sanoasa Comoda, bench element, slope to front
110	wedi Sanoasa Comoda, carrier element, round finish length
110	wedi Sanoasa Comoda, carrier element, straight finish length
110	wedi Sanoasa Comoda, corner element
111	wedi Sanoasa Comoda, end element
112	wedi Sanoasa Comoda, armrest
113	wedi Sanoasa Bellina, bench element, slope to front
113	wedi Sanoasa Bellina, carrier element, round finish length
113	wedi Sanoasa Bellina, carrier element, straight finish length
113	wedi Sanoasa Bellina, corner element
114	wedi Sanoasa Bellina, end element
115	wedi Sanoasa Bellina, armrest
115	wedi Sanoasa Loungers 1 – 5
118	wedi Sanbath Cube, tub
118	wedi Sanbath Cube, wash stand
118	wedi Sanbath Cube, shower unit
119	wedi Sanbath Wave, tub
119	wedi Sanbath Wave, wash basin
119	wedi Sanbath Wave, shower unit
120	wedi Eterna, glass door with stainless steel frame V ₄ A

Page	122 Spa and wellness projects
124	Customer-specific construction examples
126	Examples

Page	130 Technical information
132	Technical drawings of all products
176	Tiling information
177	Data enquiry form for custom-made models

01

Building boards and finished elements

The versatility of wedi structural panels is unique. Whether a complete bathroom, individual washbasin, creative shower structure or special individual piece, ideas take shape with the structural panels from wedi. They can always be cut into your desired formats and shapes and offer waterproofness and thermal insulation in one.



Don't forget: Matching accessories

- wedi 610 ▪ adhesive and sealant for waterproof adhesion of joints
- wedi Tools joint reinforcement tape ▪ to reinforce joints
- wedi Tools dowels ▪ to apply structural panels to walls

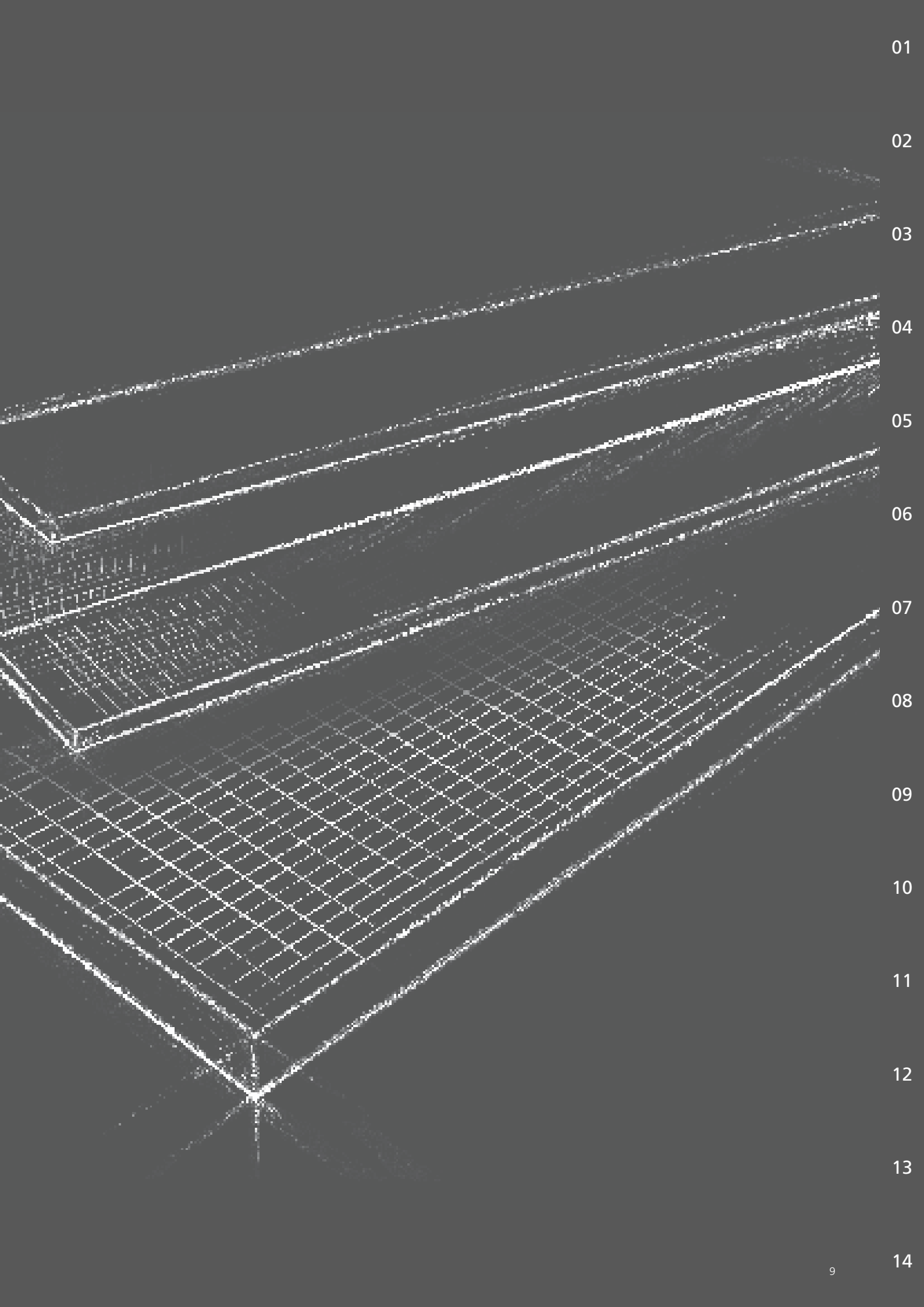

01

02

03

04

05

06

07

08

09

10

11

12

13

14

wedi building board

	Description	Length x Width x Thickness	Packing unit/Pallet	Order no.
	wedi building board	1250 x 600 x 4 mm	136 boards = 102 m ²	01-00-00/004
wedi building board	1250 x 600 x 6 mm	136 boards = 102 m ²	01-00-00/006	
wedi building board	1250 x 600 x 10 mm	100 boards = 75 m ²	01-07-00/010	
wedi building board	2500 x 600 x 4 mm	68 boards = 102 m ²	01-02-50/004	
wedi building board	2500 x 600 x 6 mm	68 boards = 102 m ²	01-02-50/006	
wedi building board	2500 x 600 x 10 mm	50 boards = 75 m ²	01-00-00/010	
wedi building board	2500 x 600 x 12,5 mm	50 boards = 75 m ²	01-00-00/112	
wedi building board	2500 x 625 x 12,5 mm	50 boards = 78,13 m ²	01-00-00/012	
wedi building board	2500 x 600 x 20 mm	50 boards = 75 m ²	01-00-00/020	
wedi building board	2500 x 600 x 30 mm	36 boards = 54 m ²	01-00-00/030	
wedi building board	2500 x 600 x 40 mm	36 boards = 54 m ²	01-00-00/040	
wedi building board	2500 x 600 x 50 mm	24 boards = 36 m ²	01-00-00/050	
wedi building board	2500 x 600 x 60 mm	24 boards = 36 m ²	01-07-10/060	
wedi building board	2500 x 600 x 80 mm	20 boards = 30 m ²	01-07-10/080	
wedi building board	2500 x 600 x 100 mm	20 boards = 30 m ²	01-07-10/199	
wedi building board	2600 x 600 x 10 mm	50 boards = 78 m ²	01-00-00/610	
wedi building board	2600 x 600 x 20 mm	50 boards = 78 m ²	01-00-00/620	
wedi building board	2600 x 600 x 30 mm	36 boards = 56,16 m ²	01-00-00/630	
wedi building board	2600 x 600 x 40 mm	36 boards = 56,16 m ²	01-00-00/640	
wedi building board	2600 x 600 x 50 mm	24 boards = 37,44 m ²	01-00-00/650	

wedi building board XL & XXL



	Description	Length x Width x Thickness	Packing unit/Pallet	Order no.
	wedi building board XL	2500 x 900 x 12,5 mm	26 boards = 58,5 m ²	01-00-00/912
wedi building board XL	2500 x 900 x 20 mm	26 boards = 58,5 m ²	01-00-00/920	
wedi building board XL	2500 x 900 x 30 mm	18 boards = 40,5 m ²	01-00-00/930	
wedi building board XL	2500 x 900 x 50 mm	12 boards = 27 m ²	01-00-00/950	
	wedi building board XXL	2600 x 1200 x 12,5 mm	26 boards = 81,12 m ²	01-00-01/612
	wedi building board XXL	2500 x 1200 x 20 mm	26 boards = 78 m ²	01-00-01/220
	wedi building board XXL	2500 x 1200 x 30 mm	18 boards = 54 m ²	01-00-01/230
	wedi building board XXL	2500 x 1200 x 50 mm	12 boards = 36 m ²	01-00-01/250

wedi building board Vapor ▪ with pre-installed vapour barrier

	Description	Length × Width × Thickness	Packing unit/Pallet	Order no.
	wedi building board Vapor, with pre-installed vapour barrier	2500 × 600 × 12,5 mm	50 boards = 75 m ²	01-07-13/112
	wedi building board Vapor, with pre-installed vapour barrier	2500 × 600 × 20 mm	50 boards = 75 m ²	01-07-13/020
	wedi building board Vapor, with pre-installed vapour barrier	2500 × 600 × 50 mm	24 boards = 36 m ²	01-07-13/050

! The thickness of the Vapor building board does not include the 1.5 mm surface coating.



wedi building board Construct ▪ lengthwise

	Description	Length × Width × Thickness	Packing unit/Pallet	Order no.
	wedi building board Construct, lengthwise	2500 × 600 × 20 mm	50 boards = 75 m ²	01-07-09/020
	wedi building board Construct, lengthwise	2500 × 600 × 30 mm	36 boards = 54 m ²	01-07-09/030
	wedi building board Construct, lengthwise	2500 × 600 × 50 mm	24 boards = 36 m ²	01-07-09/050

i Building board Construct, lengthwise, calculation of diameter

Thickness	External diameter	Full circles per board
20 mm	363 mm	0,5
30 mm	538 mm	0,4
50 mm	890 mm	0,2

wedi building board Construct ▪ widthwise

	Description	Length × Width × Thickness	Packing unit/Pallet	Order no.
	wedi building board Construct, widthwise	2500 × 600 × 20 mm	50 boards = 75 m ²	01-07-08/020
	wedi building board Construct, widthwise	2500 × 600 × 30 mm	36 boards = 54 m ²	01-07-08/030
	wedi building board Construct, widthwise	2500 × 600 × 50 mm	24 boards = 36 m ²	01-07-08/050

i Building board Construct, widthwise, calculation of diameter

Thickness	External diameter	Full circles per board
20 mm	363 mm	2,2
30 mm	538 mm	1,5
50 mm	890 mm	0,9

wedi Mensolo-L ▪ angle unit



Description	External dimensions	Length × Thickness	Packing unit/Pallet	Order no.
wedi Mensolo-L, angle unit	150 × 150 mm	2500 × 20 mm	60 units	07-43-00/091
wedi Mensolo-L, angle unit	200 × 200 mm	2500 × 20 mm	40 units	07-43-00/092
wedi Mensolo-L, angle unit	300 × 300 mm	2500 × 20 mm	40 units	07-43-00/093
wedi Mensolo-L, angle unit	200 × 400 mm	2500 × 20 mm	40 units	07-43-00/094
wedi Mensolo-L, angle unit	150 × 150 mm	2600 × 20 mm	60 units	07-43-00/691
wedi Mensolo-L, angle unit	200 × 200 mm	2600 × 20 mm	40 units	07-43-00/692
wedi Mensolo-L, angle unit	300 × 300 mm	2600 × 20 mm	40 units	07-43-00/693
wedi Mensolo-L, angle unit	200 × 400 mm	2600 × 20 mm	40 units	07-43-00/694

wedi Mensolo-U ▪ angle unit



Description	External dimensions	Length × Thickness	Packing unit/Pallet	Order no.
wedi Mensolo-U, angle unit	200 × 200 × 200 mm	2600 × 20 mm	40 units	07-43-00/695
wedi Mensolo-U, angle unit	150 × 300 × 150 mm	2600 × 20 mm	30 units	07-43-00/696

wedi Bathboard ▪ bath cladding



Description	Length × Width × Thickness	Packing unit/Pallet	Order no.
wedi Bathboard, bath cladding, side panel	1800 × 600 × 20 mm	30 units	07-38-20/100
wedi Bathboard, bath cladding, side panel	2100 × 600 × 20 mm	30 units	07-38-20/101
wedi Bathboard, bath cladding, head piece	770 × 600 × 20 mm	30 units	07-38-20/102

wedi Bathboard Shower ▪ shower tray cladding





Description	Length × Width × Thickness	Packing unit/Pallet	Order no.
wedi Bathboard Shower, shower tray cladding, side panel	900 × 200 × 20 mm	30 units	07-38-30/001
wedi Bathboard Shower, shower tray cladding, side panel	900 × 300 × 20 mm	30 units	07-38-30/002

wedi Shower-Kit

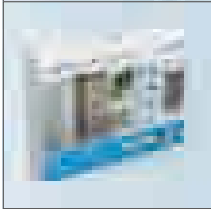
	Description	Length x Thickness	Packing unit/Pallet	Order no.
		wedi Shower-Kit, square, central drain	900 x 900 mm	5 units
	wedi Shower-Kit, rectangular, offset drain	1200 x 900 mm	5 units	07-37-37/101





-  **wedi Shower-Kit, square:**
- 1 x Fundo Primo floor element, central drain
 - 1 x wedi Fundo drain, horizontal, DN 50
 - 6 x wedi building board, 1250 x 600 x 12.5 mm
 - 2 x Fastening panels, 100 x 100 x 8 mm
 - 2 x wedi 610 cartridges
 - 1 x roll joint reinforcement tape, 25 m x 125 mm
 - 2 x roll sealing tape, 10 m x 120 mm
 - 30 x dowels, insulation board discs, self-tapping screws

-  **wedi Shower-Kit, rectangular:**
- 1 x Fundo Primo floor element, offset drain
 - 1 x wedi Fundo drain, horizontal, DN 50
 - 7 x wedi building board, 1250 x 600 x 12.5 mm
 - 2 x Fastening panels, 100 x 100 x 8 mm
 - 2 x wedi 610 cartridges
 - 1 x roll joint reinforcement tape, 25 m x 125 mm
 - 2 x roll sealing tape, 10 m x 120 mm
 - 30 x dowels, insulation board discs, self-tapping screws

wedi I-Board ▪ WC installation systems cover

	Description	Length x Width x Thickness	Packing unit/Pallet	Order no.
		wedi I-Board, WC installation systems cover	1200 x 1245 x 20 mm	30 units



-  Alternatively, the wedi I-Board can also be bonded to the front wall installation using wedi 610 adhesive sealant.
-  • 1 x wedi I-Board, WC installation systems cover
- 6 x self-tapping screws
 - 6 x wedi Tools, washer

02

Partition wall systems

With the modular wedi Moltoromo system, a variety of wall shapes can be sensationally created for different bathroom and spa uses. Round shapes, corner and elegantly arched partition wall contours are quick and easy to fit. There are no limits to the surface design with tiles, plaster and other finishes.



Don't forget: Matching accessories

- wedi 610 ▪ adhesive and sealant for waterproof adhesion of joints
- wedi Tools joint reinforcement tape ▪ to reinforce joints
- wedi Moltoromo installation set ▪ to connect two wall elements



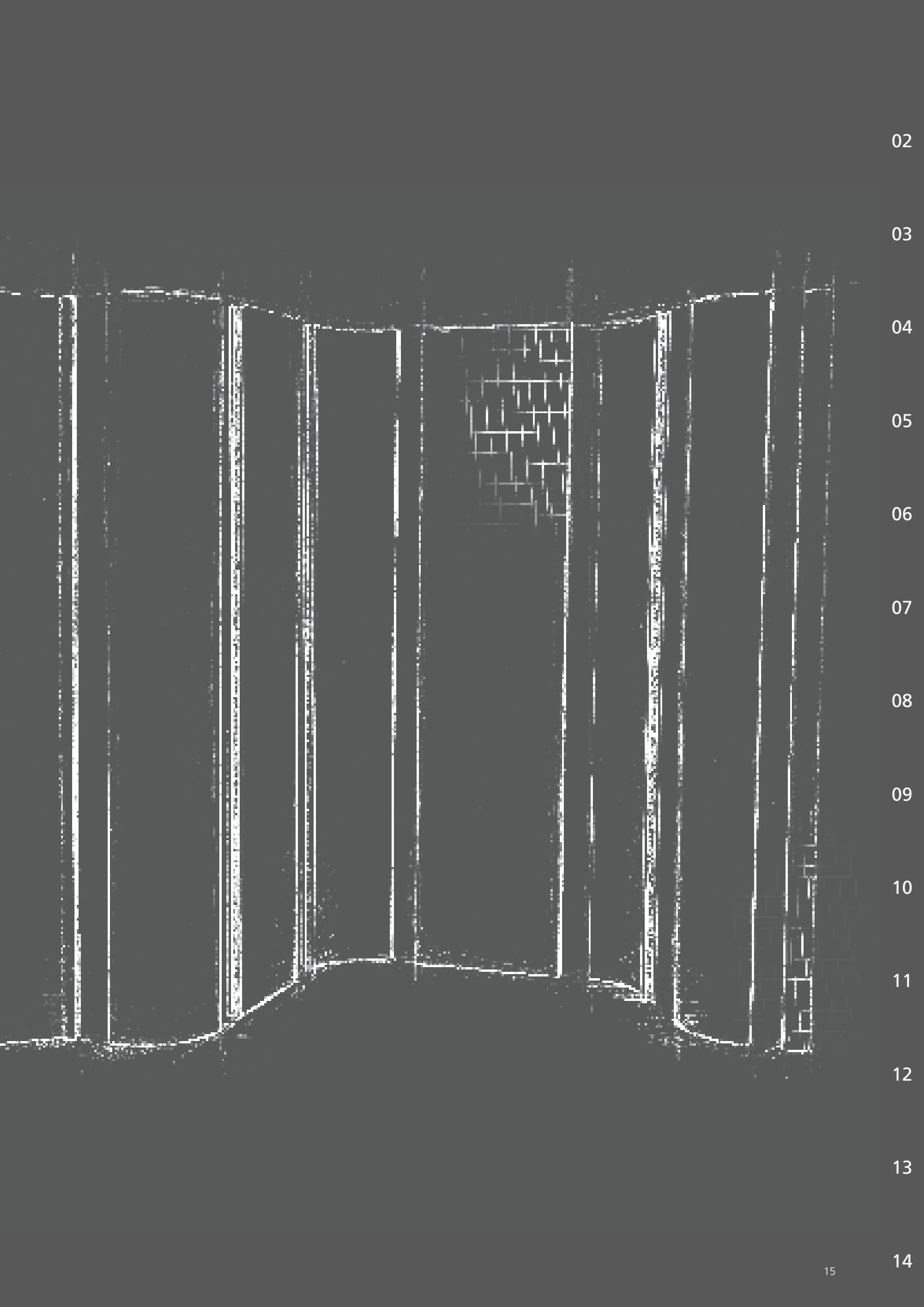

02

03

04

05

06

07

08

09

10



11

12

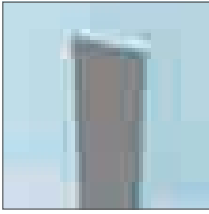

13

14



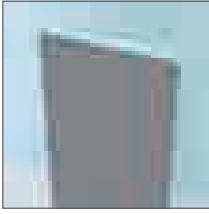

wedi Moltoromo ▪ straight wall segment, 300 mm

	Description	Length × Width × Thickness	Packing unit	Order no.
	wedi Moltoromo straight wall segment, 300 mm	2600 × 300 × 50 mm	1 unit	07-64-49/003
<p> The technical drawing for this product can be found in Chapter 14, Technology on Page 132.</p> <p> Delivery time is approx. 3 weeks ex-works.</p> <p> 1 wall segment + 2 springs</p>				



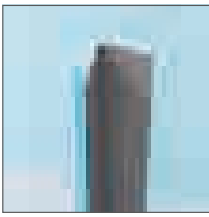

wedi Moltoromo ▪ straight wall segment, 600 mm

	Description	Length × Width × Thickness	Packing unit	Order no.
	wedi Moltoromo straight wall segment, 600 mm	2600 × 600 × 50 mm	1 unit	07-64-49/004
<p> The technical drawing for this product can be found in Chapter 14, Technology on Page 132.</p> <p> Delivery time is approx. 3 weeks ex-works.</p> <p> 1 wall segment + 2 springs</p>				



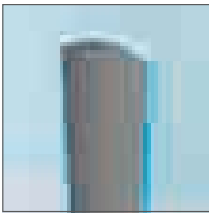

wedi Moltoromo ▪ angled wall segment

	Description	Length × Width × Thickness	Packing unit	Order no.
	wedi Moltoromo angled wall segment	2600 × 300 × 50 mm	1 unit	07-64-49/002
<p> The technical drawing for this product can be found in Chapter 14, Technology on Page 132.</p> <p> Delivery time is approx. 3 weeks ex-works.</p> <p> 1 wall segment + 2 springs</p>				

wedi Moltoromo ▪ curved wall segment, diameter 500 mm

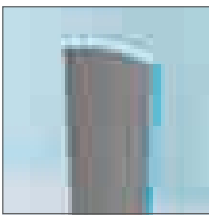
	Description	Length × Width × Thickness	Packing unit	Order no.
	wedi Moltoromo curved wall segment, diameter 500 mm	2600 × 424,3/123,1 × 50 mm	1 unit	07-64-49/005
<p> The technical drawing for this product can be found in Chapter 14, Technology on Page 132.</p> <p> Delivery time is approx. 3 weeks ex-works.</p> <p> 1 wall segment + 2 springs</p>				

wedi Moltoromo ▪ curved wall segment, diameter 1000 mm

	Description	Length × Width × Thickness	Packing unit	Order no.
	wedi Moltoromo curved wall segment, diameter 1000 mm	2600 × 421/88,1 × 50 mm	1 unit	07-64-49/006
<p> The technical drawing for this product can be found in Chapter 14, Technology on Page 132.</p> <p> Delivery time is approx. 3 weeks ex-works.</p> <p> 1 wall segment + 2 springs</p>				

wedi Moltoromo ▪ curved wall segment, diameter 1500 mm

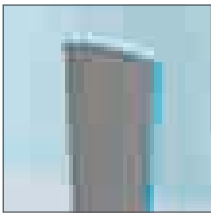

Description	Length × Width × Thickness	Packing unit	Order no.
wedi Moltoromo curved wall segment, diameter 1500 mm	2600 × 414,1/75,6 × 50 mm	1 unit	07-64-49/001
<p>i The technical drawing for this product can be found in Chapter 14, Technology on Page 132.</p> <p>! Delivery time is approx. 3 weeks ex-works.</p> <p>👑 1 wall segment + 2 springs</p>			

wedi Moltoromo ▪ straight duct segment



Description	Length × Width × Thickness	Packing unit	Order no.
wedi Moltoromo straight duct segment	2600 × 600 × 100 mm	1 unit	07-64-49/007
<p>i The technical drawing for this product can be found in Chapter 14, Technology on Page 132.</p> <p>! Delivery time is approx. 3 weeks ex-works.</p> <p>👑 1 supply segment + 2 springs</p>			

wedi Moltoromo ▪ angled duct segment

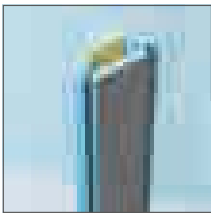

Description	Length × Width × Thickness	Packing unit	Order no.
wedi Moltoromo angled duct segment	2600 × 300/300 × 50 mm	1 unit	07-64-49/011
<p>i The technical drawing for this product can be found in Chapter 14, Technology on Page 133.</p> <p>! Delivery time is approx. 3 weeks ex-works.</p> <p>👑 1 supply segment + 2 springs</p>			

wedi Moltoromo ▪ curved duct segment, diameter 500 mm

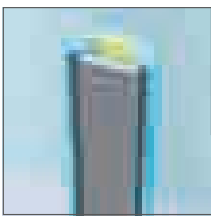



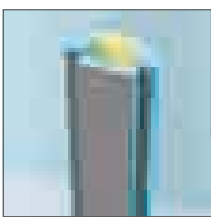

Description	Length × Width × Depth	Packing unit	Order no.
wedi Moltoromo curved duct segment, diameter 500 mm	2600 × 424,3 × 180 mm	1 unit	07-64-49/012
<p>i The technical drawing for this product can be found in Chapter 14, Technology on Page 133.</p> <p>! Delivery time is approx. 3 weeks ex-works.</p> <p>👑 1 supply segment + 2 springs</p>			

wedi Moltoromo ▪ curved duct segment, diameter 1000 mm



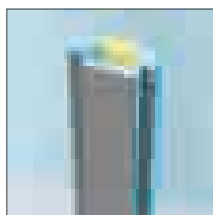



Description	Length × Width × Depth	Packing unit	Order no.
wedi Moltoromo curved duct segment, diameter 1000 mm	2600 × 421 × 150 mm	1 unit	07-64-49/013
<p>i The technical drawing for this product can be found in Chapter 14, Technology on Page 133.</p> <p>! Delivery time is approx. 3 weeks ex-works.</p> <p>👑 1 supply segment + 2 springs</p>			



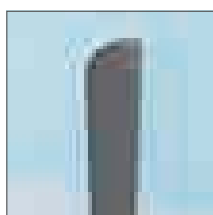

wedi Moltoromo ▪ curved duct segment, diameter 1500 mm

	Description	Length × Width × Depth	Packing unit	Order no.
	wedi Moltoromo curved duct segment, diameter 1500 mm	2600 × 414,1 × 140 mm	1 unit	07-64-49/014
	<p> The technical drawing for this product can be found in Chapter 14, Technology on Page 133.</p> <p> Delivery time is approx. 3 weeks ex-works.</p> <p> 1 supply segment + 2 springs</p>			



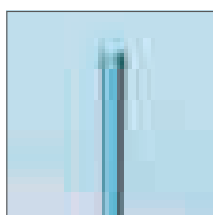

wedi Moltoromo ▪ corner profile

	Description	Length × Width × Thickness	Packing unit	Order no.
	wedi Moltoromo corner profile, inside radius 180 mm	2600 × 200/200 × 10 mm	1 unit	07-64-49/010
	<p> The technical drawing for this product can be found in Chapter 14, Technology on Page 134.</p> <p> Delivery time is approx. 3 weeks ex-works.</p> <p> 1 corner profile</p>			

wedi Moltoromo ▪ centered end profile

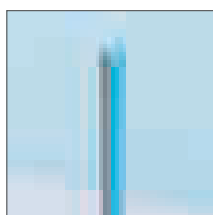
	Description	Length × Width × Depth	Packing unit	Order no.
	wedi Moltoromo centered end profile	2600 × 100 × 93,3 mm	1 unit	07-64-49/008
	<p> The technical drawing for this product can be found in Chapter 14, Technology on Page 134.</p> <p> Delivery time is approx. 3 weeks ex-works.</p> <p> 1 end profile + 1 spring</p>			

wedi Moltoromo ▪ lateral end profile

	Description	Length × Width × Depth	Packing unit	Order no.
	wedi Moltoromo lateral end profile	2600 × 100 × 100 mm	1 unit	07-64-49/009
	<p> The technical drawing for this product can be found in Chapter 14, Technology on Page 134.</p> <p> Delivery time is approx. 3 weeks ex-works.</p> <p> 1 end profile</p>			

wedi Moltoromo ▪ installation set

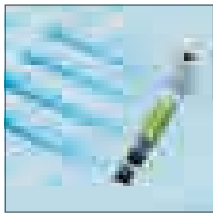

Description	Packing unit	Order no.
wedi Moltoromo installation set	1 unit	07-64-49/015

- ! ▪ Accessories tailored for two wall segments.
- Delivery time is approx. 3 weeks ex-works.
- 👑 ▪ 2 x fixing blocks 50 x 50 x 32 mm
- 4 x soft pads 500 x 50 x 30 mm
- 1 roll of self-adhesive joint reinforcement tape 25 m
- 1 cartridge of wedi 610 adhesive sealant
- 1 installation instructions

wedi Moltoromo ▪ wall / door fixing set



Description	Packing unit	Order no.
wedi Moltoromo wall / door fixing set	1 unit	07-64-49/016

- ! ▪ Accessories tailored for two wall segments.
- Delivery time is approx. 3 weeks ex-works.
- 👑 ▪ 2 x fixing strips 1300 x 30 x 15 mm
- 6 nailed dowel, Mea 6 x 80 mm

02

03

04

05

06

07

08

09

10

11

12

13

14

03

Installation materials & sealing

"Anything your heart desires" for the simple assembly of wedi structural panel elements. From special adhesives and medium-bed mortar to connectors and special protective covering fabric: You will find all the system sealing, adhesion and assembly aids you need in our accessories range. These wedi tools are perfectly coordinated with each other in order to guarantee complete watertightness in the entire system.

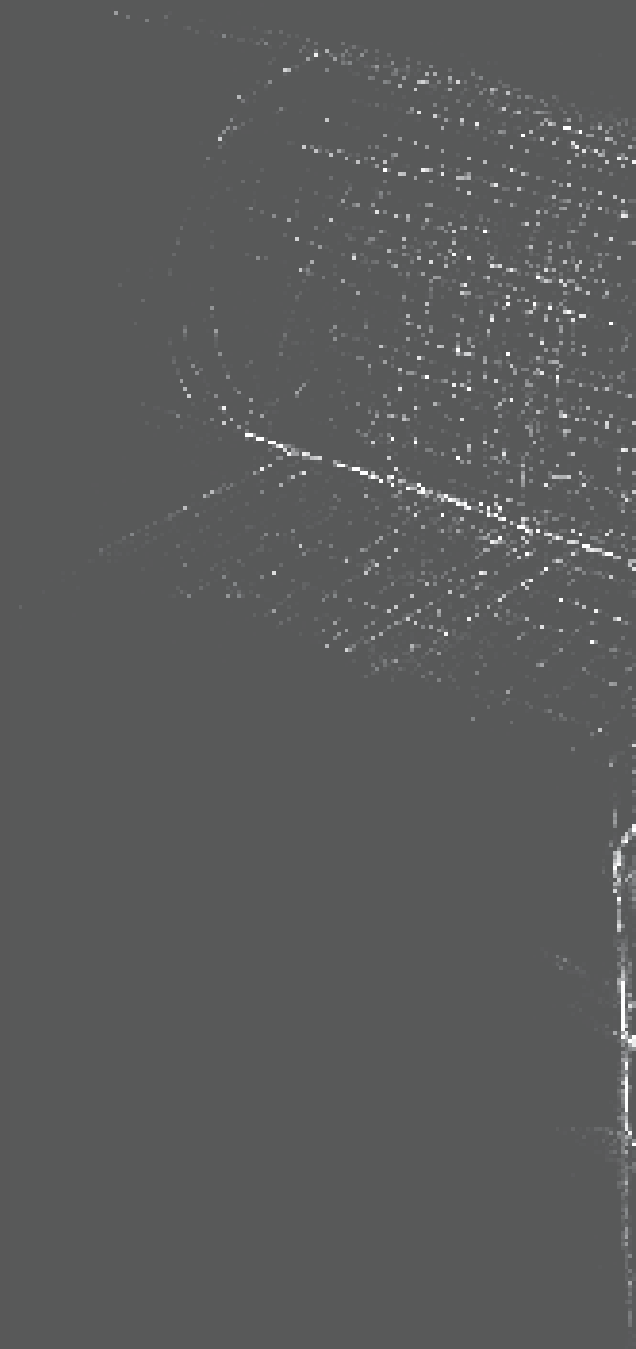

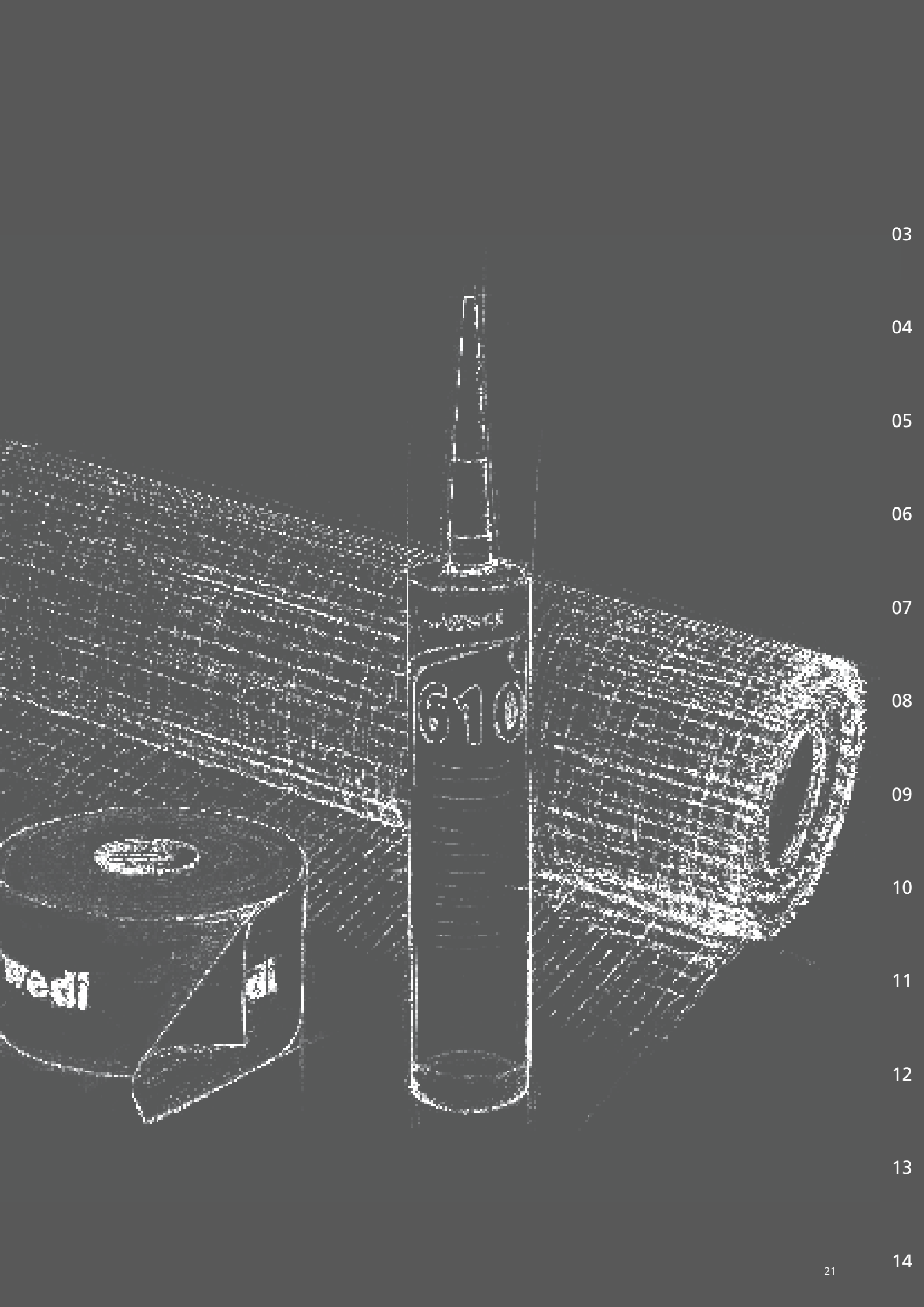

03

04

05

06

07

08

09

10

11

12

13

14

wedi 610 ▪ adhesive sealant

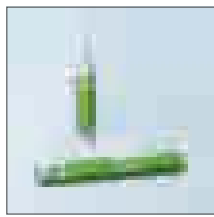

Description	Content	Packing unit	Packing unit/box	Order no.
wedi 610, adhesive sealant	310 ml	1 Cartridge	20 units	07-69-02/002
NEW wedi 610, adhesive sealant	600 ml	1 Tubular bag	20 units	07-69-02/007

- i** ▪ Consumption: 8 – 10 m per cartridge
- Adhesive and sealant for waterproof adhesion of wedi building boards and Fundo elements

wedi 520 ▪ Flexible sealants

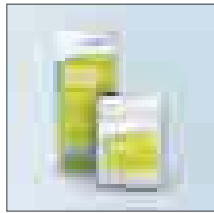

Description	Content	Packing unit	Packing unit/Pallet	Order no.
wedi 520, Flexible sealants, component A + B	20 kg + 10 kg	1 sack + 1 can	40 units	11-99-00/520

- i** ▪ Consumption per m² (for surface sealing):
wedi 520 component A (powder) at 2 mm dry layer thickness (approx. 2.4 mm wet layer thickness): approx. 2,8 kg/m²
wedi 520 component B (fluid) at 2 mm dry layer thickness (approx. 2.4 mm wet layer thickness): approx. 1,4 kg/m²
- Consumption per serial metre (for joint sealing):
wedi 520 component A (powder) at 2 mm dry layer thickness (approx. 2.4 mm wet layer thickness): approx. 0,28 kg/serial metre
wedi 520 component B (fluid) at 2 mm dry layer thickness (approx. 2.4 mm wet layer thickness): approx. 0,14 kg/serial metre

wedi edge insulation strips



Description	Roll length × Width × Thickness	Packing unit	Order no.
wedi edge insulation strips	25 m × 150 mm × 5 mm	1 roll	01-12-55/006

wedi Tools ▪ joint reinforcement tape



Description	Roll length × Width	Packing unit/box	Order no.
wedi Tools, joint reinforcement tape	25 m × 125 mm	1 roll	09-52-20/053
wedi Tools, joint reinforcement tape	50 m × 600 mm	1 roll	09-52-10/052

- i** Band to reinforce and stabilise structural panel joints



wedi Tools ▪ joint reinforcement tape, self-adhesive



Description	Roll length × Width	Packing unit/box	Order no.
wedi Tools, joint reinforcement tape, self-adhesive	25 m × 125 mm	1 roll	09-52-25/053
wedi Tools, joint reinforcement tape, self-adhesive	50 m × 600 mm	1 roll	09-52-15/052

- i** Self-adhesive band to reinforce and stabilise structural panel joints

wedi Fundo sealing set

Description	Packing unit	Order no.
 wedi Fundo sealing set	1 bucket	07-37-96/000
<p>! A Fundo sealing set is sufficient for installing a Fundo floor element including the respective wall elements.</p> <ul style="list-style-type: none">  2,4 kg powder component 1,2 kg liquid component 10 m sealing tape 2 inside corners 		

wedi Tools ■ sealing tape, fleece laminated

Description	Roll length × Width	Packing unit/box	Order no.
 wedi Tools, sealing tape, fleece laminated	50 m × 100 mm	1 roll	09-51-00/352
wedi Tools, sealing tape, fleece laminated	10 m × 120 mm	1 roll	09-51-10/311
wedi Tools, sealing tape, fleece laminated	50 m × 120 mm	1 roll	09-51-10/352

wedi Tools ■ inside corners, fleece laminated

Description	Length of side piece	Packing unit/box	Order no.
 wedi Tools, inside corners, fleece laminated	120 × 120 mm	25 units	09-51-30/001

wedi Tools ■ outside corners, fleece laminated

Description	Length of side piece	Packing unit/box	Order no.
 wedi Tools, outside corners, fleece laminated	115 × 115 mm	25 units	09-51-35/001

wedi Tools ■ sealing gaiter

Description	Dimensions	Packing unit/Sachet	Order no.
 wedi Tools, sealing gaiter, fleece laminated, extendable, suitable for 1/2" to 3/4" feed-throughs	120 × 120 mm	10 units	09-51-20/050
wedi Tools, sealing gaiter, fleece laminated, extendable DN 40 – 75	150 × 150 mm	5 units	09-51-10/361
wedi Tools, sealing gaiter, fleece laminated, extendable DN 90 – 125, also for fittings	250 × 250 mm Ø 135 mm	5 units	09-51-10/362

wedi Tools ▪ butyl bathtub sealing tape

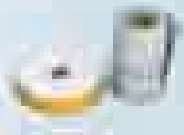
	Description	Roll length × Width	Packing unit/box	Order no.
	wedi butyl bathtub sealing tape	3600 × 120 mm	1 roll	09-51-10/360
	wedi butyl bathtub sealing tape + self-adhesive decoupling strip	3600 × 120 mm 3600 × 30 mm	1 Set	09-51-10/363

wedi Subliner Dry ▪ sealing membrane

	Description	Roll length × Width	Packing unit/Pallet	Order no.
	wedi Subliner Dry, sealing membrane	30 m × 1 m	40 rolls	09-51-10/332
wedi Subliner Dry, sealing membrane	5 m × 1 m	96 rolls	09-51-10/305	

! Flexible sealing membrane for medium and high wet areas inside.

wedi Subliner Dry & Flex ▪ sealing and decoupling membrane

	Description	Roll length × Width	Packing unit/Pallet	Order no.
	wedi Subliner Dry & Flex, sealing and decoupling membrane	15 m × 1 m	36 rolls	09-51-10/315

! Sealing and decoupling membrane for medium and high wet areas inside and outside with crack bypassing properties.

wedi protective covering fabric

	Description	Roll length × Width	Packing unit/Pallet	Order no.
	wedi protective covering fabric	25 m × 1 m	12 rolls	08-46-00/100

wedi Tools ▪ connector 90°

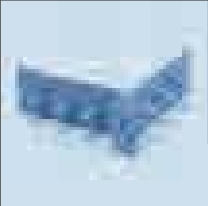
	Description	Packing unit/Blister	Packing unit/box	Order no.
	wedi Tools, connector 90°		100 units	09-53-00/191
	wedi Tools, connector 90°	5 units		09-53-03/191

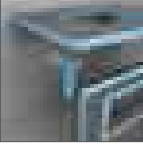



03

04

wedi Tools ▪ wall connector

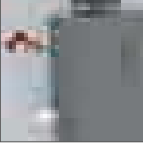
	Description	Packing unit/Blister	Packing unit/box	Order no.
	wedi Tools, wall connector		100 units	09-53-00/192
	wedi Tools, wall connector	5 units		09-53-03/192

05

06

07

08

wedi Tools ▪ connector 180°

	Description	Packing unit/Blister	Packing unit/box	Order no.
	wedi Tools, connector 180°		100 units	09-53-00/193
	wedi Tools, connector 180°	5 units		09-53-03/193

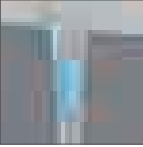
09

10



11

12

13

14

wedi Tools ▪ metal dowels, galvanised

	Description	Length	Packing unit/ Blister	Packing unit/ box	Order no.
	wedi Tools, metal dowels, galvanised	50 mm		100 units	09-49-20/104
	wedi Tools, metal dowels, galvanised	80 mm		100 units	09-49-20/108
	wedi Tools, metal dowels, galvanised	80 mm	10 units		09-49-23/108
	wedi Tools, metal dowels, galvanised	110 mm		100 units	09-49-20/111
	wedi Tools, metal dowels, galvanised	110 mm	10 units		09-49-22/111
	wedi Tools, metal dowels, galvanised	140 mm		100 units	09-49-20/114
	wedi Tools, metal dowels, galvanised	140 mm	10 units		09-49-22/114
	wedi Tools, metal dowels, galvanised	200 mm		100 units	09-49-20/122



- i** ▪ Nailed dowels hole 8 mm
 - Anchoring depth in the sub-surface: at least 35 mm
 - 5 dowels per m²

wedi Tools ▪ metal dowels, stainless steel



	Description	Length	Packing unit/ Blister	Packing unit/ box	Order no.
	wedi Tools, metal dowels, V ₂ A stainless steel	80 mm		100 units	09-49-40/108
	wedi Tools, metal dowels, V ₂ A stainless steel	80 mm	10 units		09-49-41/108
	wedi Tools, metal dowels, V ₂ A stainless steel	110 mm		100 units	09-49-40/111
	wedi Tools, metal dowels, V ₂ A stainless steel	110 mm	10 units		09-49-41/111
	wedi Tools, metal dowels, V ₂ A stainless steel	140 mm		100 units	09-49-40/114
	wedi Tools, metal dowels, V ₂ A stainless steel	140 mm	10 units		09-49-41/114

- i** ▪ Nailed dowels hole 8 mm
 - Anchoring depth in the sub-surface: at least 35 mm
 - 5 dowels per m²

wedi Tools ▪ washer, galvanised

	Description	Diameter	Packing unit/ Blister	Packing unit/ box	Order no.
	wedi Tools, washer, galvanised	35 mm		100 units	09-48-60/106
	wedi Tools, washer, galvanised	35 mm	10 units		09-48-62/106



wedi Tools ▪ washer, stainless steel

	Description	Diameter	Packing unit/ Blister	Packing unit/ box	Order no.
	wedi Tools, washer, V ₂ A stainless steel	35 mm		100 units	09-48-60/239
	wedi Tools, washer, V ₂ A stainless steel	35 mm	10 units		09-48-61/239

03

04

wedi Tools ▪ fixings set

	Description	Length × Width × Thickness	Number / set	Order no.
	wedi Tools, fixings set, composite material	400 × 50 × 15 mm 100 × 100 × 8 mm	2 units 12 units	20-65-53/001
	<p>i • This is a set consisting of 12 small panels (100 × 100 × 8 mm) and 2 elongated panels (400 × 50 × 15 mm). • To reinforce wedi structural panels for the purpose of fixing loads.</p> <p>! • For secure hold of heavy objects, such as fittings or solid shelves, under the tiles. • For bond tensile strength values of up to 160 kg.</p>			



05

06

07

08

wedi Tools ▪ cavity dowels set

	Description	Diameter × Length	Packing unit	Order no.
	wedi Tools, cavity dowels set, 10 dowels and 10 screws	screw: Ø 4,5 × 60 mm dowel: Ø 6,0 × 35 mm	1 Sachet	20-65-53/004
	<p>i The dowels are particularly suited to fastening hooks, towel rails, small pieces of mounted furniture to tiled wedi structural panels.</p> <p>! • To fix bathroom accessories, such as mirrors, towel rails, etc. after tiling. • For loads of up to 25 kg.</p>			

09

10

11

12

13

14

04

Ready-to-use surface for Fundo shower systems

Fundo Top is a new aesthetic solution for wedi Fundo floor elements. It provides a high quality alternative to traditional tiles. Made in one piece without joints from a thin, robust mineral material, it is the ideal solution for those who want a quick and easy installation without compromising quality or watertightness. Designed for the floor elements Fundo Primo, Plano and Riolito neo, the new Fundo Top elements perfectly adapt to the slope and are particularly simple and fast to install. Lightweight and easy to trim, they adapt to all rooms and always guarantee a 100% waterproof installation.



Don't forget: Matching accessories

- Fundo Primo, Riolito neo and Plano floor elements ▪ wedi Fundo floor-level elements, available in various forms and sizes with different drain systems
- wedi 610 ▪ adhesive and sealant for waterproof adhesion of joints within the wedi system

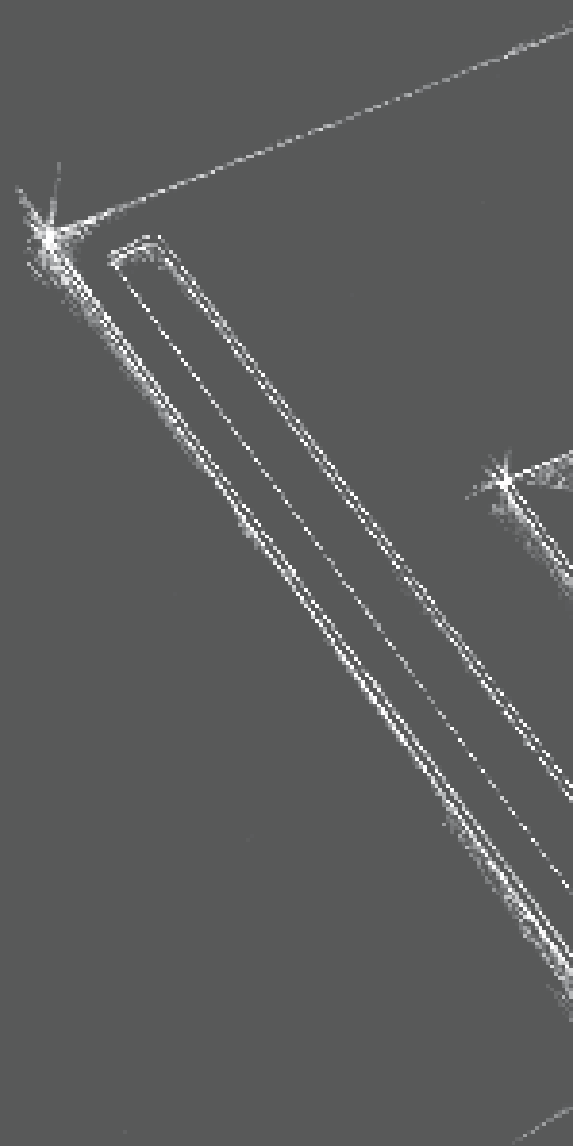

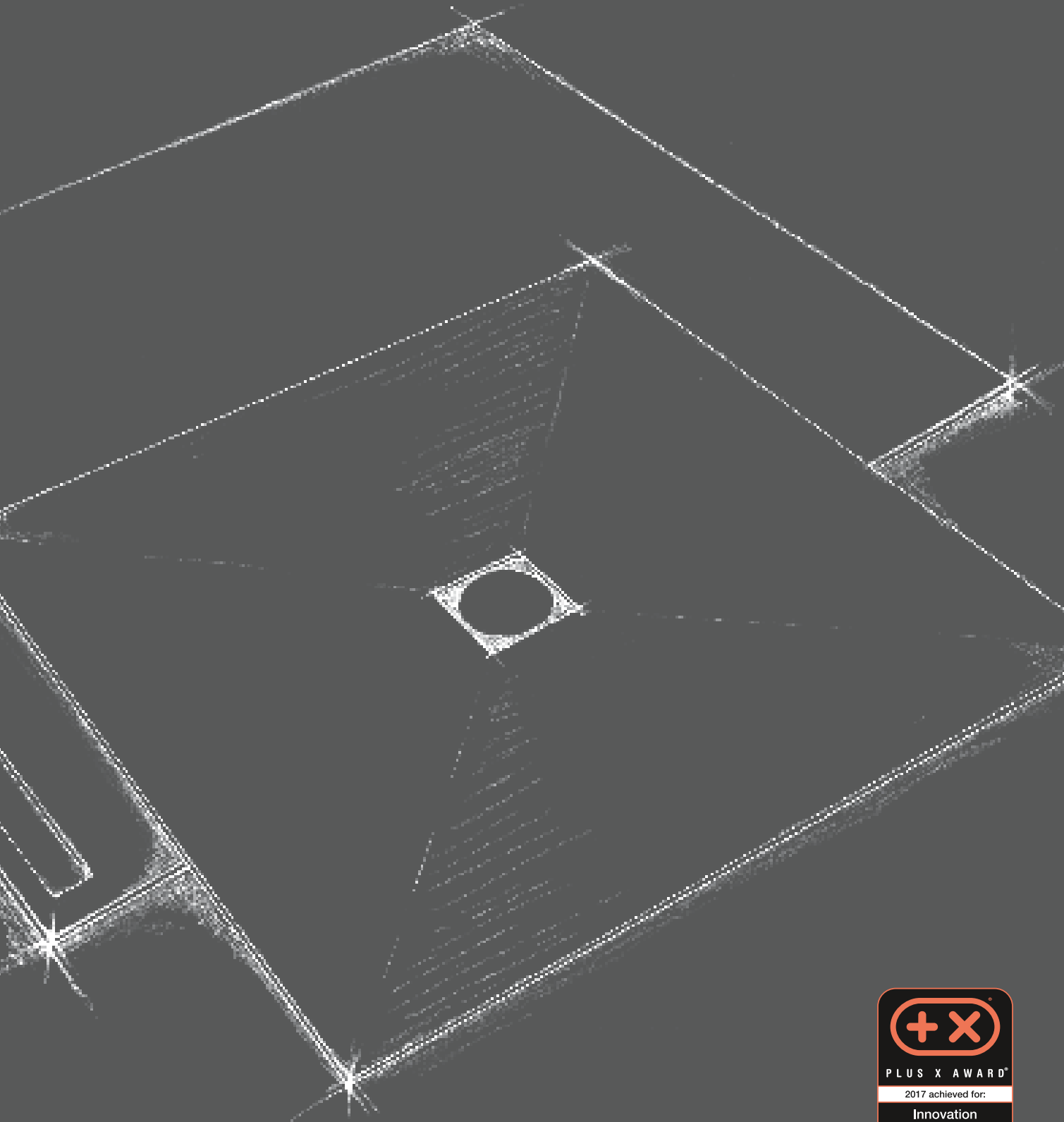

04

05

06

07

08

09

10

11

12

13

14

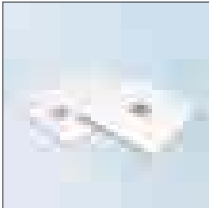

Fundo Top Primo ▪ ready-to-use surface, white

	Description	Length × Width × Thickness	Packing unit/ Pallet	Order no.
	Fundo Top Primo, ready-to-use surface, square, central drain, for Fundo Primo 07-37-35/170	900 × 900 × 6 mm	10 units	07-20-10/100
Fundo Top Primo, ready-to-use surface, rectangular, central drain, for Fundo Primo 07-37-35/174	1200 × 900 × 6 mm	10 units	07-20-10/101	
Fundo Top Primo, ready-to-use surface, rectangular, offset drain, for Fundo Primo 07-37-36/174	1200 × 900 × 6 mm	10 units	07-20-10/102	
Fundo Top Primo, ready-to-use surface, square, central drain, for Fundo Primo 07-37-35/171	1200 × 1200 × 6 mm	10 units	07-20-10/103	
Fundo Top Primo, ready-to-use surface, rectangular, central drain, for Fundo Primo 07-37-35/580	1800 × 900 × 6 mm	10 units	07-20-10/104	
Fundo Top Primo, ready-to-use surface, rectangular, offset drain, for Fundo Primo 07-37-35/180	1800 × 900 × 6 mm	10 units	07-20-10/105	

 • One packing unit = 10 pieces, all Fundo Tops can be ordered individually!

 1 ready-to-use surface

▪ Fundo Top should not be placed/used in the vicinity of a steam outlet in the hammam. The maximum permissible temperature is 70 °C.

 The Fundo Primo floor elements can be found on Page 40.

 The technical drawings for these products can be found in Chapter 14, Technology on Page 134.

Fundo Top Primo ▪ ready-to-use surface, beige

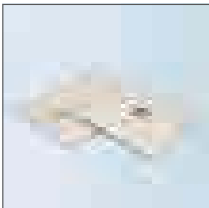
	Description	Length × Width × Thickness	Packing unit/ Pallet	Order no.
	Fundo Top Primo, ready-to-use surface, square, central drain, for Fundo Primo 07-37-35/170	900 × 900 × 6 mm	10 pièces	07-20-10/200
Fundo Top Primo, ready-to-use surface, rectangular, central drain, for Fundo Primo 07-37-35/174	1200 × 900 × 6 mm	10 pièces	07-20-10/201	
Fundo Top Primo, ready-to-use surface, rectangular, offset drain, for Fundo Primo 07-37-36/174	1200 × 900 × 6 mm	10 pièces	07-20-10/202	
Fundo Top Primo, ready-to-use surface, square, central drain, for Fundo Primo 07-37-35/171	1200 × 1200 × 6 mm	10 pièces	07-20-10/203	
Fundo Top Primo, ready-to-use surface, rectangular, central drain, for Fundo Primo 07-37-35/580	1800 × 900 × 6 mm	10 pièces	07-20-10/204	
Fundo Top Primo, ready-to-use surface, rectangular, offset drain, for Fundo Primo 07-37-35/180	1800 × 900 × 6 mm	10 pièces	07-20-10/205	

 • One packing unit = 10 pieces, all Fundo Tops can be ordered individually!

 1 ready-to-use surface

▪ Fundo Top should not be placed/used in the vicinity of a steam outlet in the hammam. The maximum permissible temperature is 70 °C.

 The Fundo Primo floor elements can be found on Page 40.

 The technical drawings for these products can be found in Chapter 14, Technology on Page 134.

Fundo Top Primo ▪ ready-to-use surface, grey

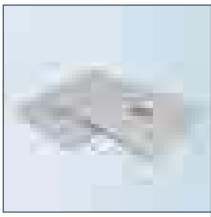

Description	Length × Width × Thickness	Packing unit/ Pallet	Order no.
Fundo Top Primo, ready-to-use surface, square, central drain, for Fundo Primo 07-37-35/170	900 × 900 × 6 mm	10 pièces	07-20-10/400
Fundo Top Primo, ready-to-use surface, rectangular, central drain, for Fundo Primo 07-37-35/174	1200 × 900 × 6 mm	10 pièces	07-20-10/401
Fundo Top Primo, ready-to-use surface, rectangular, offset drain, for Fundo Primo 07-37-36/174	1200 × 900 × 6 mm	10 pièces	07-20-10/402
Fundo Top Primo, ready-to-use surface, square, central drain, for Fundo Primo 07-37-35/171	1200 × 1200 × 6 mm	10 pièces	07-20-10/403
Fundo Top Primo, ready-to-use surface, rectangular, central drain, for Fundo Primo 07-37-35/580	1800 × 900 × 6 mm	10 pièces	07-20-10/404
Fundo Top Primo, ready-to-use surface, rectangular, offset drain, for Fundo Primo 07-37-35/180	1800 × 900 × 6 mm	10 pièces	07-20-10/405

! ▪ One packing unit = 10 pieces, all Fundo Tops can be ordered individually!

 1 ready-to-use surface

▪ Fundo Top should not be placed/used in the vicinity of a steam outlet in the hammam. The maximum permissible temperature is 70 °C.

 The Fundo Primo floor elements can be found on Page 40.

 The technical drawings for these products can be found in Chapter 14, Technology on Page 134.

Fundo Top Primo ▪ ready-to-use surface, anthracite



Description	Length × Width × Thickness	Packing unit/ Pallet	Order no.
Fundo Top Primo, ready-to-use surface, square, central drain, for Fundo Primo 07-37-35/170	900 × 900 × 6 mm	10 pièces	07-20-10/300
Fundo Top Primo, ready-to-use surface, rectangular, central drain, for Fundo Primo 07-37-35/174	1200 × 900 × 6 mm	10 pièces	07-20-10/301
Fundo Top Primo, ready-to-use surface, rectangular, offset drain, for Fundo Primo 07-37-36/174	1200 × 900 × 6 mm	10 pièces	07-20-10/302
Fundo Top Primo, ready-to-use surface, square, central drain, for Fundo Primo 07-37-35/171	1200 × 1200 × 6 mm	10 pièces	07-20-10/303
Fundo Top Primo, ready-to-use surface, rectangular, central drain, for Fundo Primo 07-37-35/580	1800 × 900 × 6 mm	10 pièces	07-20-10/304
Fundo Top Primo, ready-to-use surface, rectangular, offset drain, for Fundo Primo 07-37-35/180	1800 × 900 × 6 mm	10 pièces	07-20-10/305

! ▪ One packing unit = 10 pieces, all Fundo Tops can be ordered individually!

 1 ready-to-use surface

▪ Fundo Top should not be placed/used in the vicinity of a steam outlet in the hammam. The maximum permissible temperature is 70 °C.

 The Fundo Primo floor elements can be found on Page 40.

 The technical drawings for these products can be found in Chapter 14, Technology on Page 134.

Fundo Top Plano ▪ ready-to-use surface, white

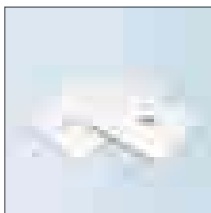
	Description	Length × Width × Thickness	Packing unit/ Pallet	Order no.
	Fundo Top Plano, ready-to-use surface, square, central drain, for Fundo Plano 07-37-35/600	900 × 900 × 6 mm	10 pièces	07-20-30/100
Fundo Top Plano, ready-to-use surface, rectangular, central drain, for Fundo Plano 07-37-35/603 and 07-37-35/604	1200 × 900 × 6 mm	10 pièces	07-20-30/101	
Fundo Top Plano, ready-to-use surface, rectangular, offset drain, for Fundo Plano 07-37-35/606	1600 × 1000 × 6 mm	10 pièces	07-20-30/102	

 ▪ One packing unit = 10 pieces, all Fundo Tops can be ordered individually!

 1 ready-to-use surface

▪ Fundo Top should not be placed/used in the vicinity of a steam outlet in the hammam. The maximum permissible temperature is 70 °C.

 The Fundo Plano floor elements can be found on Page 85.

 The technical drawings for these products can be found in Chapter 14, Technology on Page 135.

Fundo Top Plano ▪ ready-to-use surface, beige

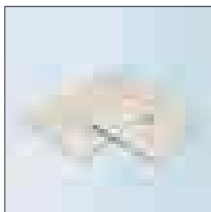
	Description	Length × Width × Thickness	Packing unit/ Pallet	Order no.
	Fundo Top Plano, ready-to-use surface, square, central drain, for Fundo Plano 07-37-35/600	900 × 900 × 6 mm	10 pièces	07-20-30/200
Fundo Top Plano, ready-to-use surface, rectangular, central drain, for Fundo Plano 07-37-35/603 and 07-37-35/604	1200 × 900 × 6 mm	10 pièces	07-20-30/201	
Fundo Top Plano, ready-to-use surface, rectangular, offset drain, for Fundo Plano 07-37-35/606	1600 × 1000 × 6 mm	10 pièces	07-20-30/202	

 ▪ One packing unit = 10 pieces, all Fundo Tops can be ordered individually!

 1 ready-to-use surface

▪ Fundo Top should not be placed/used in the vicinity of a steam outlet in the hammam. The maximum permissible temperature is 70 °C.

 The Fundo Plano floor elements can be found on Page 85.

 The technical drawings for these products can be found in Chapter 14, Technology on Page 135.

Fundo Top Plano ▪ ready-to-use surface, grey

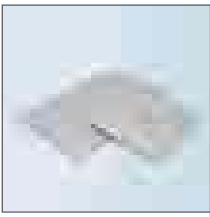

Description	Length × Width × Thickness	Packing unit/ Pallet	Order no.
Fundo Top Plano, ready-to-use surface, square, central drain, for Fundo Plano 07-37-35/600	900 × 900 × 6 mm	10 pièces	07-20-30/400
Fundo Top Plano, ready-to-use surface, rectangular, central drain, for Fundo Plano 07-37-35/603 and 07-37-35/604	1200 × 900 × 6 mm	10 pièces	07-20-30/401
Fundo Top Plano, ready-to-use surface, rectangular, offset drain, for Fundo Plano 07-37-35/606	1600 × 1000 × 6 mm	10 pièces	07-20-30/402

! ▪ One packing unit = 10 pieces, all Fundo Tops can be ordered individually!

 1 ready-to-use surface

▪ Fundo Top should not be placed/used in the vicinity of a steam outlet in the hammam. The maximum permissible temperature is 70 °C.

 The Fundo Plano floor elements can be found on Page 85.

 The technical drawings for these products can be found in Chapter 14, Technology on Page 135.

Fundo Top Plano ▪ ready-to-use surface, anthracite



Description	Length × Width × Thickness	Packing unit/ Pallet	Order no.
Fundo Top Plano, ready-to-use surface, square, central drain, for Fundo Plano 07-37-35/600	900 × 900 × 6 mm	10 pièces	07-20-30/300
Fundo Top Plano, ready-to-use surface, rectangular, central drain, for Fundo Plano 07-37-35/603 and 07-37-35/604	1200 × 900 × 6 mm	10 pièces	07-20-30/301
Fundo Top Plano, ready-to-use surface, rectangular, offset drain, for Fundo Plano 07-37-35/606	1600 × 1000 × 6 mm	10 pièces	07-20-30/302

! ▪ One packing unit = 10 pieces, all Fundo Tops can be ordered individually!

 1 ready-to-use surface

▪ Fundo Top should not be placed/used in the vicinity of a steam outlet in the hammam. The maximum permissible temperature is 70 °C.

 The Fundo Plano floor elements can be found on Page 85.

 The technical drawings for these products can be found in Chapter 14, Technology on Page 135.

04

05

06

07

08

09

10

11





12

13

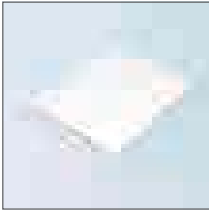
14





Fundo Top Riolito neo ▪ ready-to-use surface, white

	Description	Length × Width × Thickness	Packing unit/ Pallet	Order no.
	Fundo Top Riolito neo, ready-to-use surface, rectangular, for Fundo Riolito neo 07-51-00/004	1200 × 900 × 6 mm	10 pièces	07-20-20/100
	Fundo Top Riolito neo, ready-to-use surface, rectangular, for Fundo Riolito neo 07-51-00/034	1600 × 1000 × 6 mm	10 pièces	07-20-20/101
	Fundo Top Riolito neo, ready-to-use surface, rectangular, for Fundo Riolito neo 07-51-00/005	1800 × 900 × 6 mm	10 pièces	07-20-20/102

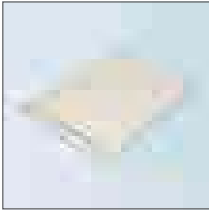
-  ▪ One packing unit = 10 pieces, all Fundo Tops can be ordered individually!  1 ready-to-use surface
- Fundo Top should not be placed/used in the vicinity of a steam outlet in the hammam. The maximum permissible temperature is 70 °C.
-  The Fundo Riolito neo floor elements can be found on Page 69.
-  The technical drawings for these products can be found in Chapter 14, Technology on Page 136.





Fundo Top Riolito neo ▪ ready-to-use surface, beige

	Description	Length × Width × Thickness	Packing unit/ Pallet	Order no.
	Fundo Top Riolito neo, ready-to-use surface, rectangular, for Fundo Riolito neo 07-51-00/004	1200 × 900 × 6 mm	10 pièces	07-20-20/200
	Fundo Top Riolito neo, ready-to-use surface, rectangular, for Fundo Riolito neo 07-51-00/034	1600 × 1000 × 6 mm	10 pièces	07-20-20/201
	Fundo Top Riolito neo, ready-to-use surface, rectangular, for Fundo Riolito neo 07-51-00/005	1800 × 900 × 6 mm	10 pièces	07-20-20/202

-  ▪ One packing unit = 10 pieces, all Fundo Tops can be ordered individually!  1 ready-to-use surface
- Fundo Top should not be placed/used in the vicinity of a steam outlet in the hammam. The maximum permissible temperature is 70 °C.
-  The Fundo Riolito neo floor elements can be found on Page 69.
-  The technical drawings for these products can be found in Chapter 14, Technology on Page 136.

Fundo Top Riolito neo ▪ ready-to-use surface, grey

	Description	Length × Width × Thickness	Packing unit/ Pallet	Order no.
	Fundo Top Riolito neo, ready-to-use surface, rectangular, for Fundo Riolito neo 07-51-00/004	1200 × 900 × 6 mm	10 pièces	07-20-20/400
	Fundo Top Riolito neo, ready-to-use surface, rectangular, for Fundo Riolito neo 07-51-00/034	1600 × 1000 × 6 mm	10 pièces	07-20-20/401
	Fundo Top Riolito neo, ready-to-use surface, rectangular, for Fundo Riolito neo 07-51-00/005	1800 × 900 × 6 mm	10 pièces	07-20-20/402

-  ▪ One packing unit = 10 pieces, all Fundo Tops can be ordered individually!  1 ready-to-use surface
- Fundo Top should not be placed/used in the vicinity of a steam outlet in the hammam. The maximum permissible temperature is 70 °C.
-  The Fundo Riolito neo floor elements can be found on Page 69.
-  The technical drawings for these products can be found in Chapter 14, Technology on Page 136.

Fundo Top Riolito neo ▪ ready-to-use surface, anthracite



Description	Length × Width × Thickness	Packing unit/ Pallet	Order no.
Fundo Top Riolito neo, ready-to-use surface, rectangular, for Fundo Riolito neo 07-51-00/004	1200 × 900 × 6 mm	10 pièces	07-20-20/300
Fundo Top Riolito neo, ready-to-use surface, rectangular, for Fundo Riolito neo 07-51-00/034	1600 × 1000 × 6 mm	10 pièces	07-20-20/301
Fundo Top Riolito neo, ready-to-use surface, rectangular, for Fundo Riolito neo 07-51-00/005	1800 × 900 × 6 mm	10 pièces	07-20-20/302

! ▪ One packing unit = 10 pieces, all Fundo Tops can be ordered individually!

👑 1 ready-to-use surface

▪ Fundo Top should not be placed/used in the vicinity of a steam outlet in the hammam. The maximum permissible temperature is 70 °C.

📖 The Fundo Riolito neo floor elements can be found on Page 69.

i The technical drawings for these products can be found in Chapter 14, Technology on Page 136.

Fundo Top tileable channel cover

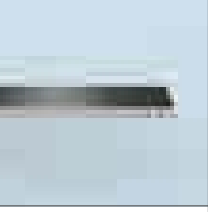

Description	Length	Packing unit	Order no.
Fundo Top tileable channel cover, white	800 mm	1 pièce	07-20-00/100
Fundo Top tileable channel cover, beige	800 mm	1 pièce	07-20-00/200
Fundo Top tileable channel cover, grey	800 mm	1 pièce	07-20-00/400
Fundo Top tileable channel cover, anthracite	800 mm	1 pièce	07-20-00/300

! ▪ For installation heights of 5 to 25 mm.

▪ The trough depth is 11 mm.

👑 ▪ 1 Fundo Top tileable channel cover 800 mm

▪ 1 screw set of 4 pieces

Fundo Top cladding

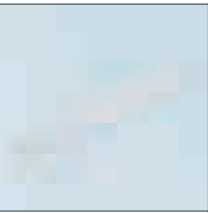

Description	Length	Packing unit	Order no.
Fundo Top cladding, white	1880 × 200 × 6 mm	1 unit	07-20-40/100
Fundo Top cladding, beige	1880 × 200 × 6 mm	1 unit	07-20-40/200
Fundo Top cladding, grey	1880 × 200 × 6 mm	1 unit	07-20-40/400
Fundo Top cladding, anthracite	1880 × 200 × 6 mm	1 unit	07-20-40/300

Fundo Top Primo ▪ ready-to-use surface for Fundo Primo

	Surface, white	Surface, beige	Surface, grey	Surface, anthracite
Fundo Top Primo, square, central drain 900 × 900 × 6 mm				
Fundo Top Primo, square, central drain 1200 × 1200 × 6 mm				
Fundo Top Primo, rectangular, central drain 1200 × 900 × 6 mm				
Fundo Top Primo, rectangular, central drain 1800 × 900 × 6 mm				
Fundo Top Primo, rectangular, offset drain 1200 × 900 × 6 mm				
Fundo Top Primo, rectangular, offset drain 1800 × 900 × 6 mm				

Fundo Top Plano ▪ ready-to-use surface for Fundo Plano

	Surface, white	Surface, beige	Surface, grey	Surface, anthracite
Fundo Top Plano, square, central drain 900 × 900 × 6 mm				
Fundo Top Plano, rectangular, central drain 1200 × 900 × 6 mm				
Fundo Top Plano, rectangular, offset drain 1600 × 1000 × 6 mm				

Fundo Top Riolito neo ▪ ready-to-use surface for Fundo Riolito neo

	Surface, white	Surface, beige	Surface, grey	Surface, anthracite
Fundo Top Riolito neo, rectangular 1200 × 900 × 6 mm				
Fundo Top Riolito neo, rectangular 1800 × 900 × 6 mm				
Fundo Top Riolito neo, rectangular 1600 × 1000 × 6 mm				

04

05

06

07

08

09

10

11

12

13

14

05

Point drainage

The very essence of quality. When it comes to classic point drainage, the versatile wedi system environment offers shower floor elements in a wide range of sizes and shapes. Whether central or decentralised drain – complete and compatible drain systems tailored to the purpose can be found for all floor elements. For special designs, wedi can also create customised special floor elements. All designs are united in their watertightness, high system reliability with manufacturer guarantee and quick and easy processing.



Don't forget: Matching accessories

- wedi 610 ▪ adhesive and sealant for waterproof adhesion of joints within the wedi system
- wedi Fundo sealing set ▪ for all-round sealing of Fundo floor elements to adjacent materials, e.g. screed
- wedi Fundo drains ▪ horizontal/vertical drains for flush-to-floor showers with point drainage
- wedi grates ▪ exclusive optional grates for point drainage

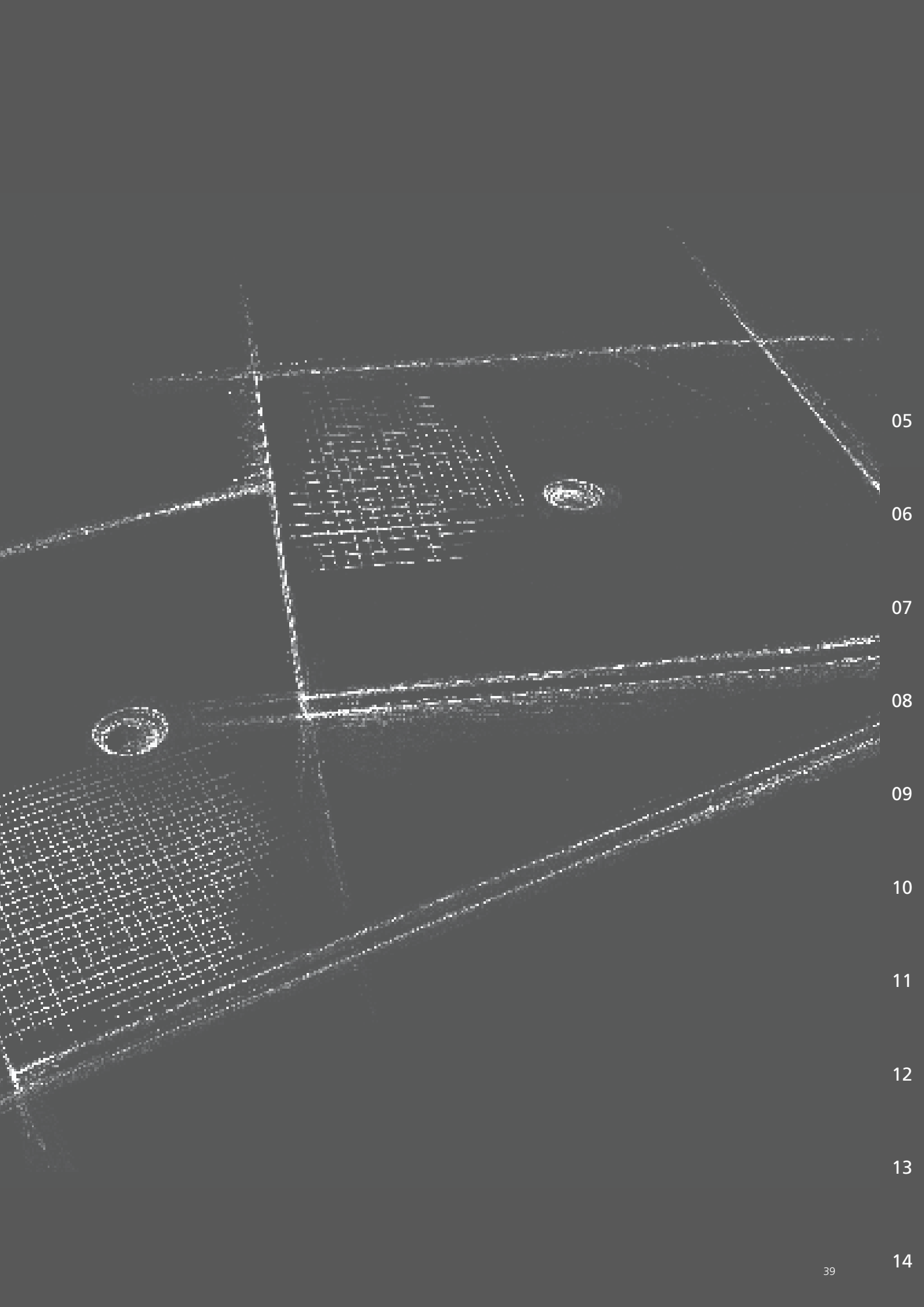

05

06

07

08

09

10

11

12



13

14

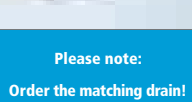
Fundo Primo ▪ floor element square, central drain

	Description	Length × Width × Thickness	Packing unit/Pallet	Order no.
	Fundo Primo, floor element, central drain	900 × 900 × 40 mm	10 units	07-37-35/170
	Fundo Primo, floor element, central drain	1000 × 1000 × 40 mm	10 units	07-37-35/131
	Fundo Primo, floor element, central drain	1200 × 1200 × 40 mm	10 units	07-37-35/171
	Fundo Primo, floor element, central drain	1500 × 1500 × 40 mm	10 units	07-37-35/175



Please note:
Order the matching drain!

-  ▪ One packing unit = 10 pieces; piece acceptance possible!
- Only wedi drainage systems for Fundo can be installed with Fundo floor elements.
-  The technical drawings for these products can be found in Chapter 14, Technology on Page 137.

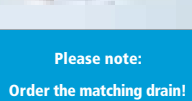

Fundo Primo ▪ floor element square, corner drain

	Description	Length × Width × Thickness	Packing unit/Pallet	Order no.
	Fundo Primo, floor element, corner drain	900 × 900 × 40 mm	10 units	07-37-36/170
	Fundo Primo, floor element, corner drain	1000 × 1000 × 40 mm	10 units	07-37-35/531
	Fundo Primo, floor element, corner drain	1200 × 1200 × 40 mm	10 units	07-37-36/171
	Fundo Primo, floor element, corner drain	1500 × 1500 × 40 mm	10 units	07-37-36/175

Please note:
Order the matching drain!

-  ▪ One packing unit = 10 pieces; piece acceptance possible!
- Only wedi drainage systems for Fundo can be installed with Fundo floor elements.
-  The technical drawings for these products can be found in Chapter 14, Technology on Page 137.

Fundo Primo ▪ floor element rectangular, central drain



	Description	Length × Width × Thickness	Packing unit/Pallet	Order no.
	Fundo Primo, floor element, central drain	900 × 750 × 40 mm	10 units	07-37-35/176
	Fundo Primo, floor element, central drain	1200 × 900 × 40 mm	10 units	07-37-35/174
Please note: Order the matching drain!	Fundo Primo, floor element, central drain	1400 × 900 × 40 mm	10 units	07-37-35/196
	Fundo Primo, floor element, central drain	1400 × 1000 × 40 mm	10 units	07-37-35/198
	Fundo Primo, floor element, central drain	1500 × 900 × 40 mm	10 units	07-37-36/120
	Fundo Primo, floor element, central drain	1500 × 1000 × 40 mm	10 units	07-37-36/121
	Fundo Primo, floor element, central drain	1800 × 900 × 40 mm	10 units	07-37-35/580

! ▪ One packing unit = 10 pieces; piece acceptance possible!

▪ Only wedi drainage systems for Fundo can be installed with Fundo floor elements.

i The technical drawings for these products can be found in Chapter 14, Technology on Page 138.

Fundo Primo ▪ floor element rectangular, offset drain

	Description	Length × Width × Thickness	Packing unit/Pallet	Order no.
	Fundo Primo, floor element, offset drain	1200 × 900 × 40 mm	10 units	07-37-36/174
	Fundo Primo, floor element, offset drain	1400 × 900 × 40 mm	10 units	07-37-35/150
	Fundo Primo, floor element, offset drain	1600 × 900 × 40 mm	10 units	07-37-35/151
	Fundo Primo, floor element, offset drain	1600 × 1000 × 40 mm	10 units	07-37-35/152
Please note: Order the matching drain!	Fundo Primo, floor element, offset drain	1800 × 900 × 40 mm	10 units	07-37-35/180



! ▪ One packing unit = 10 pieces; piece acceptance possible!

▪ Only wedi drainage systems for Fundo can be installed with Fundo floor elements.

i The technical drawings for these products can be found in Chapter 14, Technology on Page 139.



wedi Fundo special floor element ▪ with point drainage

	Description	Dimensions	Restrictions	Order no.
	wedi Fundo special floor element, square, rectangular, one piece	Length X: max. 2400 mm Width Y: max. 1500 mm Thickness: 40 mm + 50 mm	Dimensions YA = min. 200 mm XA = min. 200 mm	07-37-14/099

-  ▪ Delivery time ex-works
7 days after final technical clearance and release of order. (Only applies to orders of 1 to 3 units; larger numbers of units require an individual check).
- The drains for special floor elements must be ordered separately.
-  ▪ The technical drawings for these products can be found in Chapter 14, Technology on Page 140.
- Drains can be positioned wherever you like for all individual designs.

wedi Fundo Individual ▪ special floor element with point drainage

	Description	Dimensions	Restrictions	Order no.
	wedi Fundo Individual, multi-corner; round; multi-piece; individual dimensions, design and thickness	Length X: individual Width Y: individual Thickness: individual	Technical feasibility check	07-37-14/499



-  ▪ Delivery time ex-works
Manual check, 21 days after final technical clearance and release of order
- The drains for special floor elements must be ordered separately.
-  ▪ The technical drawings for these products can be found in Chapter 14, Technology on Page 140.
- Drains can be positioned wherever you like for all individual designs.

wedi sloping board ▪ Fundo Primo

	Description	Length × Width × Thickness	Packing unit/Pallet	Order no.
	wedi sloping board 1, Fundo Primo	600 × 1200 × 40 / 46 mm	40 units	07-37-37/001
	wedi sloping board 2, Fundo Primo	600 × 1200 × 46 / 52 mm	40 units	07-37-37/002



-  ▪ The technical drawings for these products can be found in Chapter 14, Technology on Page 141.

Fundo Borgo ▪ floor element, corner drain

	Description	Length × Width × Thickness	Packing unit/Pallet	Order no.
	Fundu Borgo, floor element	900 × 900 × 40 mm	10 units	07-37-35/576
	Fundu Borgo, floor element	1000 × 1000 × 40 mm	10 units	07-37-36/576
	<p>! ▪ One packing unit = 10 pieces; piece acceptance possible!</p> <p>▪ Only wedi drainage systems for Fundo can be installed with Fundo floor elements.</p>			
	<p>i The technical drawings for these products can be found in Chapter 14, Technology on Page 141.</p>			
<p>Please note: Order the matching drain!</p>				

05

Fundo Trollo ▪ floor element, central drain

	Description	Diameter × Thickness	Packing unit/Pallet	Order no.
	Fundu Trollo, floor element	Ø 1140 × 40 mm	10 units	07-37-36/575
	<p>! ▪ One packing unit = 10 pieces; piece acceptance possible!</p> <p>▪ Only wedi drainage systems for Fundo can be installed with Fundo floor elements.</p> <p>i The technical drawing for this product can be found in Chapter 14, Technology on Page 141.</p>			
<p>Please note: Order the matching drain!</p>				

m² Fundo Trollo, floor element: approx. 0,80 m²



06

07

08

09

Fundo Trollo ▪ wall element

	Description	Height	Packing unit	Order no.
	Fundu Trollo, wall element	2015 mm	1 unit	04-17-09/002
	Extension collar (incl. 1 cartridge of wedi 610)	500 mm	1 unit	04-17-09/052
<p>! The glass door can only be mounted after tiling.</p> <p>i The technical drawings for these products can be found in Chapter 14, Technology on Page 142.</p> <p>👑 Fundo Trollo, wall element:</p> <ul style="list-style-type: none"> ▪ 2 wall segments type A ▪ 3 wall segments type B ▪ 5 springs ▪ 1 × 25 m self adhesive joint reinforcement tape ▪ 5 × wedi 610, adhesive sealant 				

10

11

12

13

14

Fundo Trollo libero ▪ wall element

Description	Height	Packing unit	Order no.
Fundo Trollo libero, wall element	2015 mm	1 unit	04-17-09/003
Extension collar (incl. 1 cartridge of wedi 610)	500 mm	1 unit	04-17-09/053



- !** ▪ The Fundo Trollo libero can be positioned anywhere in the room.
- The glass door can only be mounted after tiling.
- i** The technical drawings for these products can be found in Chapter 14, Technology on Page 142.

- +** Fundo Trollo libero, wall element:
 - 2 wall segments type A
 - 1 wall segment type B
 - 1 wall segment type E (with reinforcement for fittings and shower head)
 - 1 wall segment type F (with reinforcement for installing the shower rail)
 - 1 wall segment type G
 - 1 inspection board (BA 40)
 - 5 springs
 - 1 x 25 m self adhesive joint reinforcement tape
 - 5 x wedi 610, adhesive sealant

Fundo Trollo/Trollo libero ▪ Glass doors

Description	Height	Packing unit	Order no.
Fundo Trollo/Trollo libero, Glass swing door	1990 mm	1 unit	60-80-01/100
Fundo Trollo/Trollo libero, Glass sliding door	1900 mm	1 unit	60-80-01/200



Fundo Nautilo ▪ floor element, right entry/left entry

Description	Length x Width x Thickness	Packing unit/Pallet	Order no.
Fundo Nautilo, floor element, right entry	1890 x 1515 x 50 mm	10 units	07-37-36/066
Fundo Nautilo, floor element, left entry	1890 x 1515 x 50 mm	10 units	07-37-36/065

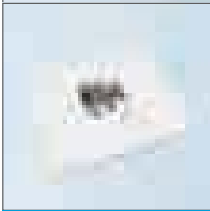



- !** ▪ One packing unit = 10 pieces; piece acceptance possible!
- Only wedi drainage systems for Fundo can be installed with Fundo floor elements.
- i** The technical drawings for these products can be found in Chapter 14, Technology on Page 143.

m² Fundo Nautilo, floor element: approx. 1,60 m²

Please note:
Order the matching drain!

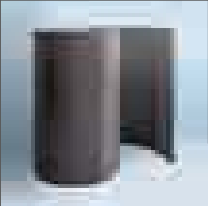
Fundo Nautilo ▪ wall element

 	Description	Height	Packing unit	Order no.
	Fundo Nautilo, wall element	2015 mm	1 unit	04-17-08/000
Extension collar (incl. 1 cartridge of wedi 610)	500 mm	1 unit	04-17-08/052	



 The Fundo Nautilo wall element can be installed for right or left entry.

 The technical drawings for these products can be found in Chapter 14, Technology on Page 143.

 Fundo Nautilo, wall element:

- 1 wall segment type A
- 2 wall segments type B
- 4 wall segments type C
- 1 wall segment type D
- 7 springs
- 2 x 25 m self-adhesive sealing tape
- 6 x wedi 610, adhesive sealant

Fundo Nautilo libero ▪ wall element

 	Description	Height	Packing unit	Order no.
	Fundo Nautilo libero, wall element	2015 mm	1 unit	04-17-08/002
Extension collar (incl. 1 cartridge of wedi 610)	500 mm	1 unit	04-17-08/053	

 The Fundo Nautilo libero can be positioned anywhere in the room.

 The Fundo Nautilo wall element can be installed for right or left entry.

 The technical drawings for these products can be found in Chapter 14, Technology on Page 144.

 Fundo Nautilo libero, wall element:

- 1 wall segment type B
- 4 wall segments type C
- 1 wall segment type D
- 1 wall segment type E (with reinforcement for fittings and shower head)
- 1 wall segment type F (with reinforcement for installing the shower rail)
- 1 wall segment type G
- 1 inspection board (BA 40)
- 8 springs
- 2 x 25 m self-adhesive sealing tape
- 7 x wedi 610, adhesive sealant

wedi Fundo vertical drain ▪ DN 50, square

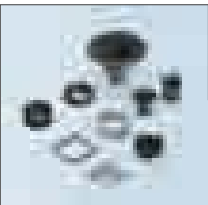
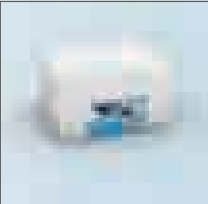
 	Description	Packing unit	Order no.
	wedi Fundo vertical drain, DN 50, square	1 unit	07-70-00/007

 Absorption capacity: 1,10 Litre/Second

- Core drilling diameter: 120 mm
- Minimum installation depth: 40 mm

 The technical drawing for this product can be found in Chapter 14, Technology on Page 144.

 The Fundo drain conforms to DIN EN 1253.

 This drain matches the following Fundo floor elements:

- Fundo Primo
- Fundo Trollo
- Fundo Borgo
- Fundo Nautilo
- Fundo Ligno



- 1 x drain cover vertical, DN 50
- 1 x shower insert
- 1 x syphon
- 1 x extension collar
- 1 x main sealing collar
- 1 x shower tray screw-type valve
- 1 x cap tool
- 1 x plastic frame, 120 x 120 mm
- 1 x Fundo Fino 1.1, drain grid stainless steel, 115 x 115 mm
- 1 x O-Ring

wedi Fundo vertical drain ▪ DN 50, round

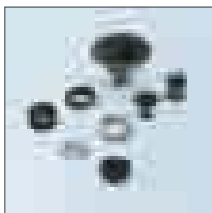
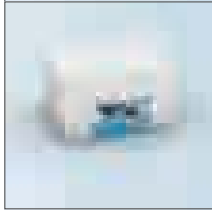
	Description	Packing unit	Order no.
	wedi Fundo vertical drain, DN 50, round	1 unit	07-70-00/008
<ul style="list-style-type: none"> ! ▪ Absorption capacity: 1,10 Litre/Second ▪ Core drilling diameter: 120 mm ▪ Minimum installation depth: 40 mm ▪ The extension collar simultaneously serves as a grate support. A special plastic frame is not required. i ▪ The technical drawing for this product can be found in Chapter 14, Technology on Page 144. ▪ The Fundo drain conforms to DIN EN 1253. ▪ This drain matches the following Fundo floor elements: <ul style="list-style-type: none"> ▪ Fundo Primo ▪ Fundo Trollo ▪ Fundo Borgo ▪ Fundo Nautilo ▪ Fundo Ligno 👑 ▪ 1 x drain cover vertical, DN 50 ▪ 1 x extension collar ▪ 1 x cap tool ▪ 1 x shower insert ▪ 1 x shower tray screw-type valve ▪ 1 x Fundo Fino 1.2, drain grid stainless steel, Ø 115 mm, round ▪ 1 x syphon ▪ 1 x main sealing collar ▪ 1 x O-Ring 			

wedi Fundo vertical drain ▪ DN 50 with fire protection collar

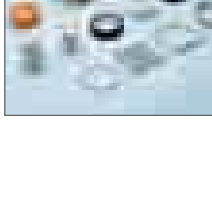
	Description	Packing unit	Order no.
	wedi Fundo vertical drain, DN 50 with fire protection collar	1 unit	07-37-49/002
<ul style="list-style-type: none"> ! ▪ Absorption capacity: 1,00 Litre/Second ▪ Core drilling diameter: 160 mm ▪ Minimum installation depth: 40 mm i ▪ The technical drawing for this product can be found in Chapter 14, Technology on Page 144. ▪ The Fundo drain conforms to DIN EN 1253. ▪ This drain matches the following Fundo floor elements: <ul style="list-style-type: none"> ▪ Fundo Primo ▪ Fundo Trollo ▪ Fundo Borgo ▪ Fundo Nautilo 👑 ▪ 1 x drain cover vertical, DN 50 ▪ 1 x fire-proofing ▪ 1 x fire-proofing-cap tool ▪ 1 x cap tool ▪ 1 x shower tray screw-type valve ▪ 1 x main sealing collar ▪ 1 x syphon ▪ 1 x shower insert ▪ 1 x extension collar ▪ 1 x plastic frame, 120 x 120 mm ▪ 1 x drain grid stainless steel, 115 x 115 mm ▪ 1 x O-Ring 			

wedi Fundo vertical drain ▪ DN 70

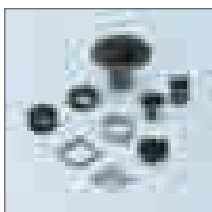
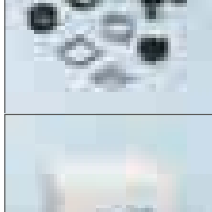
	Description	Packing unit	Order no.
	wedi Fundo vertical drain, DN 70	1 unit	07-70-00/010
<ul style="list-style-type: none"> ! ▪ Absorption capacity: 1,00 Litre/Second ▪ Core drilling diameter: 120 mm ▪ Minimum installation depth: 40 mm i ▪ The technical drawing for this product can be found in Chapter 14, Technology on Page 144. ▪ The Fundo drain conforms to DIN EN 1253. ▪ This drain matches the following Fundo floor elements: <ul style="list-style-type: none"> ▪ Fundo Primo ▪ Fundo Trollo ▪ Fundo Borgo ▪ Fundo Nautilo ▪ Fundo Ligno 👑 ▪ 1 x drain cover vertical, DN 70 ▪ 1 x extension collar ▪ 1 x cap tool ▪ 1 x shower insert ▪ 1 x shower tray screw-type valve ▪ 1 x plastic frame, 120 x 120 mm ▪ 1 x syphon ▪ 1 x main sealing collar ▪ 1 x Fundo Fino 1.1, drain grid stainless steel, 115 x 115 mm ▪ 1 x O-Ring 			

wedi Fundo horizontal drain ▪ DN 50, square

	Description	Packing unit	Order no.
	<p>wedi Fundo horizontal drain, DN 50, square</p> <ul style="list-style-type: none"> ! • Absorption capacity: 0,80 Litre/Second • Minimum installation depth: 130 mm i • The technical drawing for this product can be found in Chapter 14, Technology on Page 145. • The Fundo drain conforms to DIN EN 1253. • This drain matches the following Fundo floor elements: <ul style="list-style-type: none"> ▪ Fundo Primo ▪ Fundo Borgo ▪ Fundo Ligno ▪ Fundo Trollo ▪ Fundo Nautilo <ul style="list-style-type: none"> 🔧 • 1 x drain cover horizontal, DN 50 • 1 x extension collar • 1 x main sealing collar • 1 x shower insert • 1 x cap tool • 1 x shower tray screw-type valve • 1 x syphon • 1 x plastic frame, 120 x 120 mm • 1 x Fundo Fino 1.1, drain grid stainless steel, 115 x 115 mm • 1 x O-Ring 	1 unit	07-70-00/011

wedi Fundo horizontal drain ▪ DN 50, round

	Description	Packing unit	Order no.
	<p>wedi Fundo horizontal drain, DN 50, round</p> <ul style="list-style-type: none"> ! • Absorption capacity: 0,80 Litre/Second • Minimum installation depth: 130 mm • The extension collar simultaneously serves as a grate support. A special plastic frame is not required. i • The technical drawing for this product can be found in Chapter 14, Technology on Page 145. • The Fundo drain conforms to DIN EN 1253. • This drain matches the following Fundo floor elements: <ul style="list-style-type: none"> ▪ Fundo Primo ▪ Fundo Borgo ▪ Fundo Ligno ▪ Fundo Trollo ▪ Fundo Nautilo <ul style="list-style-type: none"> 🔧 • 1 x drain cover horizontal, DN 50 • 1 x shower insert • 1 x syphon • 1 x cap tool • 1 x shower tray screw-type valve • 1 x extension collar • 1 x main sealing collar • 1 x Fundo Fino 1.2, drain grid stainless steel, Ø 115 mm, round • 1 x O-Ring 	1 unit	07-70-00/012

wedi Fundo drain Mini Max ▪ DN 40, extra flat

	Description	Packing unit	Order no.
	<p>wedi Fundo drain Mini Max, DN 40, extra flat</p> <ul style="list-style-type: none"> ! • Absorption capacity: 0,50 Litre/Second • Minimum installation depth: 97 mm • Cannot be combined with Fundo Primo Easy Sets! i • The technical drawing for this product can be found in Chapter 14, Technology on Page 145. • The Fundo Mini Max drain is an authorised floor drain with a general building authority-approved test certificate. • This drain matches the following Fundo floor elements: <ul style="list-style-type: none"> ▪ Fundo Primo ▪ Fundo Borgo ▪ Fundo Ligno ▪ Fundo Trollo ▪ Fundo Nautilo <ul style="list-style-type: none"> 🔧 • 1 x drain cover, extra flat, DN 40 • 1 x syphon • 1 x shower insert • 1 x main sealing collar • 1 x shower tray screw-type valve • 1 x extension collar • 1 x cap tool • 1 x Fundo Fino 1.1, drain grid stainless steel, 115 x 115 mm • 1 x plastic frame, 120 x 120 mm • 1 x O-Ring 	1 unit	07-70-00/015

05

06

07

08

09

10

11

12

13

14

Fundo Primo Easy Set ▪ substructure element, square

	Description	Length × Width × Thickness	Packing unit/Pallet	Order no.
	Fundo Primo Easy Set, square, central drain	900 × 900 × 100 mm	24 units	07-37-23/000
	Fundo Primo Easy Set, square, central drain	1000 × 1000 × 100 mm	25 units	07-37-24/131
	Fundo Primo Easy Set, square, central drain	1200 × 1200 × 100 mm	25 units	07-37-24/000
	Fundo Primo Easy Set, square, central drain	1500 × 1500 × 100 mm	35 units	07-37-24/175

! • Fundo Primo Easy Set is also supplied as a construction kit.

▪ Adhesion with wedi 610 adhesive sealant (Not included in the delivery)

i The technical drawing for this product can be found in Chapter 14, Technology on Page 145.

 1 Fundo Primo Easy Set

Fundo Primo Easy Set ▪ substructure element, rectangular

	Description	Length × Width × Thickness	Packing unit/Pallet	Order no.
	Fundo Primo Easy Set, rectangular, central drain	1200 × 900 × 100 mm	24 units	07-37-24/174
	Fundo Primo Easy Set, rectangular, central drain	1800 × 900 × 100 mm	24 units	07-37-23/580

! • Fundo Primo Easy Set is also supplied as a construction kit.

▪ Adhesion with wedi 610 adhesive sealant (Not included in the delivery)

i The technical drawing for this product can be found in Chapter 14, Technology on Page 146.

 1 Fundo Primo Easy Set

Fundo Primo Easy Set ▪ substructure element, rectangular

	Description	Length × Width × Thickness	Packing unit/Pallet	Order no.
	Fundo Primo Easy Set, rectangular, offset drain	1200 × 900 × 100 mm	24 units	07-37-24/173
	Fundo Primo Easy Set, rectangular, offset drain	1800 × 900 × 100 mm	24 units	07-37-23/180

! • Fundo Primo Easy Set is also supplied as a construction kit.

▪ Adhesion with wedi 610 adhesive sealant (Not included in the delivery)

i The technical drawing for this product can be found in Chapter 14, Technology on Page 146.

 1 Fundo Primo Easy Set

wedi Fundo substrate element ■ special floor element with point drainage

Description	Dimensions	Restrictions	Order no.
wedi Fundo substrate element, square, rectangular, one piece	Length X: max. 2400 mm Width Y: max. 1500 mm Thickness: 60 – 120 mm		07-37-14/399

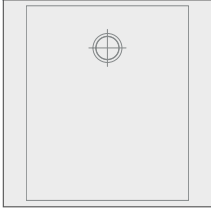

- !** • Delivery time ex-works
7 days after final technical clearance and release of order. (Only applies to orders of 1 to 3 units; larger numbers of units require an individual check).
- i** • The technical drawings for these products can be found in Chapter 14, Technology on Page 147.
- Drains can be positioned wherever you like for all individual designs.

NEW wedi Fundo substrate element Individual ■ special floor element

Description	Dimensions	Restrictions	Order no.
wedi Fundo substrate element Individual, multi-corner; round; multi-piece; individual dimensions, design and thickness	Length X: individual Width Y: individual Thickness: individual	Technical feasibility check	07-37-14/399

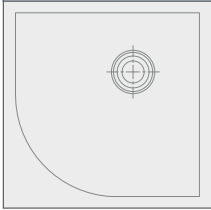
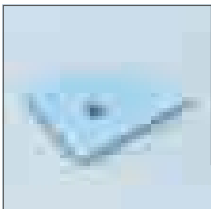

- !** • Delivery time ex-works
Manual check, 21 days after final technical clearance and release of order
- The drains for special floor elements must be ordered separately.
- Cannot be combined with the wedi Fundo vertical drain, DN 50 with fire protection collar!
- i** • The technical drawings for these products can be found in Chapter 14, Technology on Page 147.
- Drains can be positioned wherever you like for all individual designs.

wedi Shower-Kit

Description	Length x Thickness	Packing unit/Pallet	Order no.
wedi Shower-Kit, square, central drain	900 x 900 mm	5 units	07-37-37/100
wedi Shower-Kit, rectangular, offset drain	1200 x 900 mm	5 units	07-37-37/101

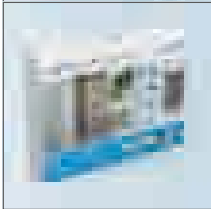
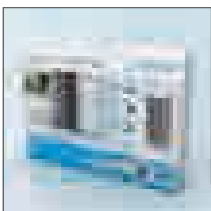

- 👑** wedi Shower-Kit, square:
 - 1 x Fundo Primo floor element, central drain
 - 1 x wedi Fundo drain, horizontal, DN 50
 - 6 x wedi building board, 1250 x 600 x 12.5 mm
 - 2 x Fastening panels, 100 x 100 x 8 mm
 - 2 x wedi 610 cartridges
 - 1 x roll joint reinforcement tape, 25 m x 125 mm
 - 2 x roll sealing tape, 10 m x 120 mm
 - 30 x dowels, insulation board discs, self-tapping screws
- 👑** wedi Shower-Kit, rectangular:
 - 1 x Fundo Primo floor element, offset drain
 - 1 x wedi Fundo drain, horizontal, DN 50
 - 7 x wedi building board, 1250 x 600 x 12.5 mm
 - 2 x Fastening panels, 100 x 100 x 8 mm
 - 2 x wedi 610 cartridges
 - 1 x roll joint reinforcement tape, 25 m x 125 mm
 - 2 x roll sealing tape, 10 m x 120 mm
 - 30 x dowels, insulation board discs, self-tapping screws

06

Wooden floor solutions

wedi has a real specialist up its sleeve for wooden floors and wooden beam ceilings. The flush-to-floor Fundo Ligno shower element has been developed especially for use on wooden floor joists in old and new buildings – and it's only 20 mm thick. This means it can be integrated perfectly into existing surface layers without the need to build up additional height. Together with the Fundo sealing set, you can achieve an all-round sealed result.



Don't forget: Matching accessories

- wedi 610 ▪ adhesive and sealant for waterproof adhesion of joints within the wedi system
- wedi Tools sealing tape ▪ for watertight connection to non-system materials
- wedi Fundo sealing set ▪ for all-round sealing of Fundo floor elements to adjacent materials, e.g. screed
- wedi Subliner Dry & Flex ▪ crack-bridging sealing and decoupling membrane
- wedi Fundo drains ▪ horizontal/vertical drains for flush-to-floor showers with point drainage
- wedi grates ▪ exclusive optional grates for point drainage

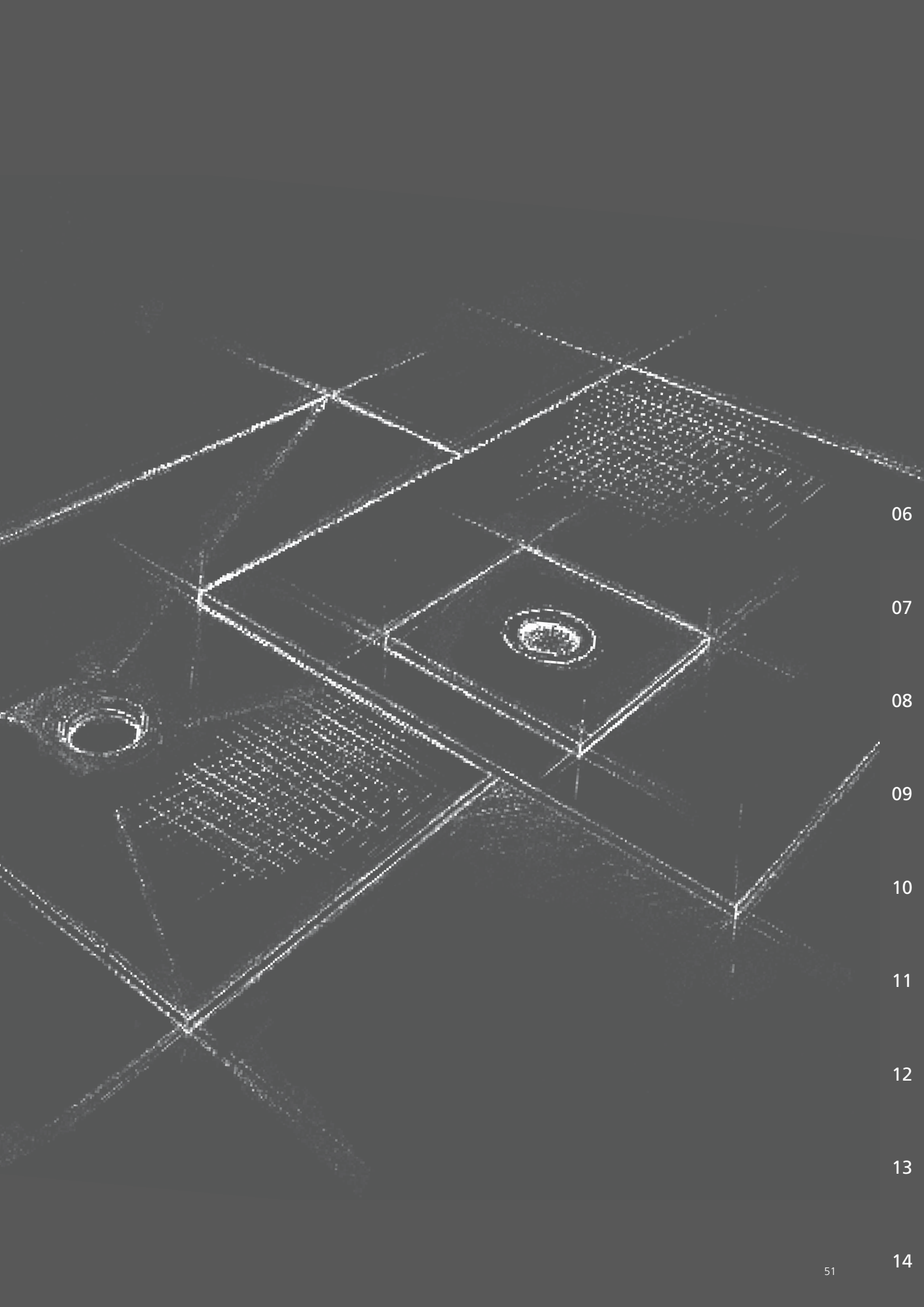

06

07

08

09

10



11

12



13

14

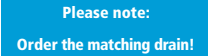

Fundo Ligno ▪ floor element square, central drain

	Description	Length × Width × Thickness	Packing unit/Pallet	Order no.
	Fundo Ligno, floor element, central drain	900 × 900 × 20/41 mm	10 units	07-37-32/011
	Fundo Ligno, floor element, central drain	1200 × 1200 × 20/41 mm	10 units	07-37-32/012
	Fundo Ligno, floor element, central drain	1500 × 1500 × 20/41 mm	10 units	07-37-32/013
	<p>! ▪ One packing unit = 10 pieces; piece acceptance possible!</p> <p>▪ Only wedi drainage systems for Fundo can be installed with Fundo floor elements.</p> <p>i The technical drawings for these products can be found in Chapter 14, Technology on Page 147.</p>			
	<p>Please note: Order the matching drain!</p>			

Fundo Ligno ▪ floor element square, corner drain

	Description	Length × Width × Thickness	Packing unit/Pallet	Order no.
	Fundo Ligno, floor element, corner drain	900 × 900 × 20/41 mm	10 units	07-37-32/021
	Fundo Ligno, floor element, corner drain	1200 × 1200 × 20/41 mm	10 units	07-37-32/023
	<p>! ▪ One packing unit = 10 pieces; piece acceptance possible!</p> <p>▪ Only wedi drainage systems for Fundo can be installed with Fundo floor elements.</p> <p>i The technical drawings for these products can be found in Chapter 14, Technology on Page 148.</p>			
<p>Please note: Order the matching drain!</p>				

Fundo Ligno ▪ floor element rectangular, offset drain

	Description	Length × Width × Thickness	Packing unit/Pallet	Order no.
	Fundo Ligno, floor element, offset drain	1200 × 900 × 20/41 mm	10 units	07-37-32/022
	Fundo Ligno, floor element, offset drain	1600 × 900 × 20/41 mm	10 units	07-37-32/024
	<p>! ▪ One packing unit = 10 pieces; piece acceptance possible!</p> <p>▪ Only wedi drainage systems for Fundo can be installed with Fundo floor elements.</p> <p>i The technical drawings for these products can be found in Chapter 14, Technology on Page 149.</p>			
<p>Please note: Order the matching drain!</p>				

Fundo Ligno Individual ▪ special floor element

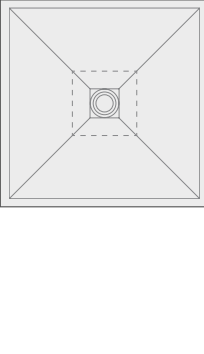
	Description	Dimensions	Restrictions	Order no.
	Fundo Ligno Individual, square, rectangular, one piece	Length X: min. 800 mm / max. 1600 mm Width Y: min. 800 mm / max. 1550 mm Thickness: 20 / 41 mm	centred: Central drain Length X: min. 800 mm max. 1600 mm Length Y: min. 800 mm max. 1550 mm	07-37-14/799
	Fundo Ligno Individual, square, rectangular, one piece	Length X: min. 800 mm / max. 1600 mm Width Y: min. 800 mm / max. 1550 mm Thickness: 20 / 41 mm	off-centred, close to the wall: Drain point 260 × 260 mm off the edge Length X: min. 800 mm max. 1260 mm Length Y: min. 800 mm max. 1260 mm	07-37-14/799
	Fundo Ligno Individual, square, rectangular, one piece	Length X: min. 800 mm / max. 1600 mm Width Y: min. 800 mm / max. 1550 mm Thickness: 20 / 41 mm	off-centered, variable: Variable drain point but the dimension of the drain axis (XA, YA) must not be less than 260 mm or more than 1000 mm off the edge! Length X: min. 800 mm max. 1600 mm Length Y: min. 800 mm max. 1550 mm	07-37-14/799

- !** ▪ Delivery time ex-works
14 days after final technical clearance and release of order. (Only applies to orders of 1 to 3 units; larger numbers of units require an individual check).
- The drains for special floor elements must be ordered separately.
- i** ▪ The technical drawing for this product can be found in Chapter 14, Technology on Page 149.
- Drains can be positioned wherever you like for all individual designs.

Fundo Ligno ▪ drain-substructure element

	Description	Length × Width × Thickness	Packing unit/Pallet	Order no.
	Fundo Ligno, drain-substructure element	338 × 338 × 82 mm	1 unit	07-37-32/090

- !** This article can only be used in combination with DN 50 vertical and horizontal Fundo drains. It is not suitable for use with the Mini Max or DN 40 drains and the DN 50 vertical drain with fire protection collar!
- i** ▪ This element can be shortened by up to 20 mm all round.
- Can also be used in combination with Fundo Primo.

06

07

08

09

10



11

12



13

14

wedi Fundo vertical drain ▪ DN 50, square

	Description	Packing unit	Order no.
	wedi Fundo vertical drain, DN 50, square	1 unit	07-70-00/007
	<ul style="list-style-type: none"> ! ▪ Absorption capacity: 1,10 Litre/Second ▪ Core drilling diameter: 120 mm ▪ Minimum installation depth: 40 mm i ▪ The technical drawing for this product can be found in Chapter 14, Technology on Page 144. ▪ The Fundo drain conforms to DIN EN 1253. ▪ This drain matches the following Fundo floor elements: <ul style="list-style-type: none"> ▪ Fundo Primo ▪ Fundo Trollo ▪ Fundo Borgo ▪ Fundo Nautilo ▪ Fundo Ligno 	<ul style="list-style-type: none"> m ▪ 1 x drain cover vertical, DN 50 ▪ 1 x shower insert ▪ 1 x syphon ▪ 1 x extension collar ▪ 1 x main sealing collar ▪ 1 x shower tray screw-type valve ▪ 1 x cap tool ▪ 1 x plastic frame, 120 x 120 mm ▪ 1 x Fundo Fino 1.1, drain grid stainless steel, 115 x 115 mm ▪ 1 x O-Ring 	



wedi Fundo vertical drain ▪ DN 50, round

	Description	Packing unit	Order no.
	wedi Fundo vertical drain, DN 50, round	1 unit	07-70-00/008
	<ul style="list-style-type: none"> ! ▪ Absorption capacity: 1,10 Litre/Second ▪ Core drilling diameter: 120 mm ▪ Minimum installation depth: 40 mm ▪ The extension collar simultaneously serves as a grate support. A special plastic frame is not required. i ▪ The technical drawing for this product can be found in Chapter 14, Technology on Page 144. ▪ The Fundo drain conforms to DIN EN 1253. ▪ This drain matches the following Fundo floor elements: <ul style="list-style-type: none"> ▪ Fundo Primo ▪ Fundo Trollo ▪ Fundo Borgo ▪ Fundo Nautilo ▪ Fundo Ligno 	<ul style="list-style-type: none"> m ▪ 1 x drain cover vertical, DN 50 ▪ 1 x extension collar ▪ 1 x cap tool ▪ 1 x shower insert ▪ 1 x shower tray screw-type valve ▪ 1 x Fundo Fino 1.2, drain grid stainless steel, Ø 115 mm, round ▪ 1 x syphon ▪ 1 x main sealing collar ▪ 1 x O-Ring 	

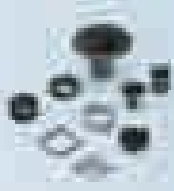
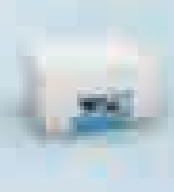

wedi Fundo vertical drain ▪ DN 70

	Description	Packing unit	Order no.
	wedi Fundo vertical drain, DN 70	1 unit	07-70-00/010
	<ul style="list-style-type: none"> ! ▪ Absorption capacity: 1,00 Litre/Second ▪ Core drilling diameter: 120 mm ▪ Minimum installation depth: 40 mm i ▪ The technical drawing for this product can be found in Chapter 14, Technology on Page 144. ▪ The Fundo drain conforms to DIN EN 1253. ▪ This drain matches the following Fundo floor elements: <ul style="list-style-type: none"> ▪ Fundo Primo ▪ Fundo Trollo ▪ Fundo Borgo ▪ Fundo Nautilo ▪ Fundo Ligno 	<ul style="list-style-type: none"> m ▪ 1 x drain cover vertical, DN 70 ▪ 1 x extension collar ▪ 1 x cap tool ▪ 1 x shower insert ▪ 1 x shower tray screw-type valve ▪ 1 x plastic frame, 120 x 120 mm ▪ 1 x syphon ▪ 1 x main sealing collar ▪ 1 x Fundo Fino 1.1, drain grid stainless steel, 115 x 115 mm ▪ 1 x O-Ring 	



wedi Fundo horizontal drain ▪ DN 50, square

	Description	Packing unit	Order no.
	<p>wedi Fundo horizontal drain, DN 50, square</p> <ul style="list-style-type: none"> ! Absorption capacity: 0,80 Litre/Second Minimum installation depth: 130 mm i The technical drawing for this product can be found in Chapter 14, Technology on Page 145. The Fundo drain conforms to DIN EN 1253. This drain matches the following Fundo floor elements: <ul style="list-style-type: none"> ▪ Fundo Primo ▪ Fundo Trollo ▪ Fundo Borgo ▪ Fundo Nautilo ▪ Fundo Ligno 	1 unit	07-70-00/011
	<ul style="list-style-type: none"> 🔧 1 x drain cover horizontal, DN 50 1 x extension collar 1 x main sealing collar 1 x shower insert 1 x cap tool 1 x shower tray screw-type valve 1 x syphon 1 x plastic frame, 120 x 120 mm 1 x Fundo Fino 1.1, drain grid stainless steel, 115 x 115 mm 1 x O-Ring 		

wedi Fundo horizontal drain ▪ DN 50, round

	Description	Packing unit	Order no.
	<p>wedi Fundo horizontal drain, DN 50, round</p> <ul style="list-style-type: none"> ! Absorption capacity: 0,80 Litre/Second Minimum installation depth: 130 mm The extension collar simultaneously serves as a grate support. A special plastic frame is not required. i The technical drawing for this product can be found in Chapter 14, Technology on Page 145. The Fundo drain conforms to DIN EN 1253. This drain matches the following Fundo floor elements: <ul style="list-style-type: none"> ▪ Fundo Primo ▪ Fundo Trollo ▪ Fundo Borgo ▪ Fundo Nautilo ▪ Fundo Ligno 	1 unit	07-70-00/012
	<ul style="list-style-type: none"> 🔧 1 x drain cover horizontal, DN 50 1 x shower insert 1 x syphon 1 x cap tool 1 x shower tray screw-type valve 1 x extension collar 1 x main sealing collar 1 x Fundo Fino 1.2, drain grid stainless steel, Ø 115 mm, round 1 x O-Ring 		

wedi Fundo drain Mini Max ▪ DN 40, extra flat

	Description	Packing unit	Order no.
	<p>wedi Fundo drain Mini Max, DN 40, extra flat</p> <ul style="list-style-type: none"> ! Absorption capacity: 0,50 Litre/Second Minimum installation depth: 97 mm Nicht kombinierbar mit den Fundo Primo Easy Sets und dem Ligno Ablauf-substructure element! i The technical drawing for this product can be found in Chapter 14, Technology on Page 145. The Fundo Mini Max drain is an authorised floor drain with a general building authority-approved test certificate. This drain matches the following Fundo floor elements: <ul style="list-style-type: none"> ▪ Fundo Primo ▪ Fundo Trollo ▪ Fundo Borgo ▪ Fundo Nautilo ▪ Fundo Ligno 	1 unit	07-70-00/015
	<ul style="list-style-type: none"> 🔧 1 x drain cover, extra flat, DN 40 1 x syphon 1 x shower insert 1 x main sealing collar 1 x shower tray screw-type valve 1 x extension collar 1 x cap tool 1 x Fundo Fino 1.1, drain grid stainless steel, 115 x 115 mm 1 x plastic frame, 120 x 120 mm 1 x O-Ring 		

06

07

08

09

10

11

12

13

14



Drain grates

The new wedi grates impress with their quality and design. It is precisely these details which give your bathroom a very special touch. Whether in round or square format, as a standard design or in solid stainless steel – the various choices offer the right solution for any bathroom design.

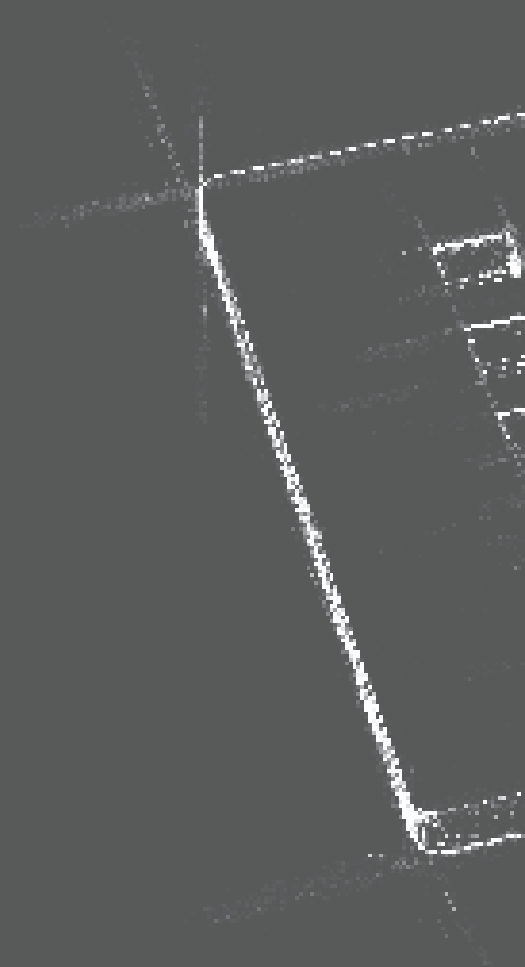

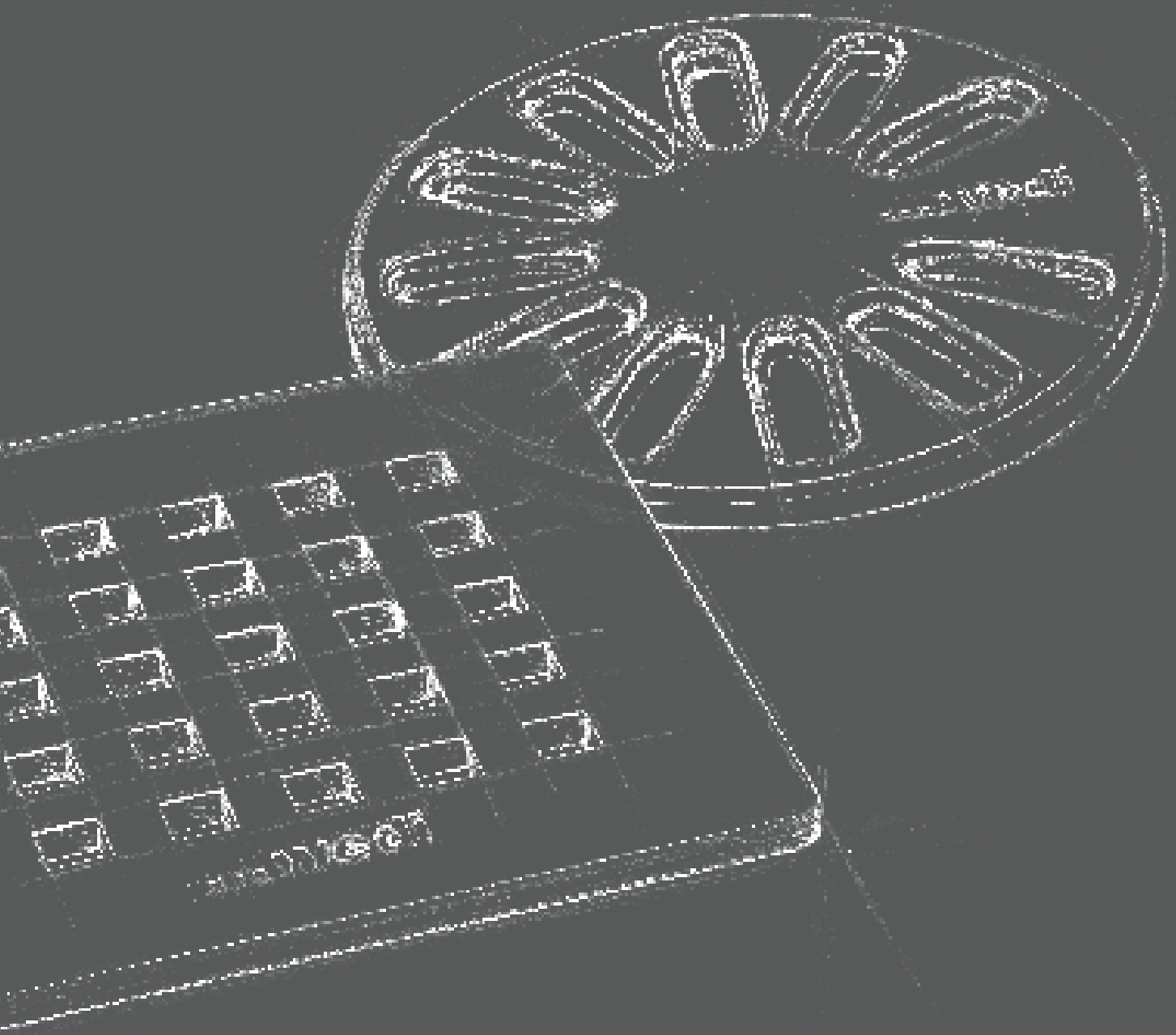

07

08

09

10

11

12

13

14

Fundo Fino 1.1 ▪ drain grid, stainless steel, square

	Description	Length × Width × Height	Packing unit	Order no.
	Fundo Fino 1.1, drain grid, square, stainless steel	115 × 115 × 5 mm	1 unit	67-68-00/033
<p>i This grate is included as the standard grate in the drain sets for Fundo Primo.</p>		<p>👑 ▪ 1 drain grid ▪ 1 plastic frame</p>		

Fundo Fino 1.2 ▪ drain grid, stainless steel, round

	Description	Diameter × Height	Packing unit	Order no.
	Fundo Fino 1.2, drain grid, round, stainless steel	Ø 115 × 5 mm	1 unit	67-68-00/034
		<p>👑 1 drain grid</p>		

Fundo Fino 1.3 ▪ drain grid, stainless steel, square, screw in

	Description	Length × Width × Height	Packing unit	Order no.
	Fundo Fino 1.3, drain grid, square, stainless steel, screw in, incl. stainless steel frames	115 × 115 × 5 mm	1 unit	67-68-00/035
<p>! For this drain grid, the height of your tiling must be at least 8.5 mm.</p>		<p>👑 ▪ 1 drain grid ▪ 1 frame ▪ 2 stainless steel screws</p>		

Fundo Fino 2.1 ▪ drain grid, stainless steel, square

	Description	Length × Width × Height	Packing unit	Order no.
	Fundo Fino 2.1, drain grid, square, stainless steel	115 × 115 × 5 mm	1 unit	67-68-00/037
		<p>👑 ▪ 1 drain grid ▪ 1 plastic frame</p>		

Fundo Fino 2.2 ▪ drain grid, stainless steel, round

	Description	Diameter × Height	Packing unit	Order no.
	Fundo Fino 2.2, drain grid, round, stainless steel	Ø 115 × 5 mm	1 unit	67-68-00/038
		<p>👑 1 drain grid</p>		

! Fundo Fino drain grids can also be combined with Fundo Integro. For this purpose, the receptacle PVC frame of Fundo Fino must be used.

Fundo Fino 2.3 ▪ drain grid, stainless steel, square, screw in



Description	Length × Width × Height	Packing unit	Order no.
Fundo Fino 2.3, drain grid, square, stainless steel, screw in, incl. stainless steel frames	115 × 115 × 5 mm	1 unit	67-68-00/039

! For this drain grid, the height of your tiling must be at least 8.5 mm.

-  ▪ 1 drain grid
- 1 frame
- 2 stainless steel screws

Fundo Fino 3.1 ▪ drain grid, stainless steel, square



Description	Length × Width × Height	Packing unit	Order no.
Fundo Fino 3.1, drain grid, square, stainless steel	115 × 115 × 5 mm	1 unit	67-68-00/040

-  ▪ 1 drain grid
- 1 plastic frame

Fundo Fino 3.2 ▪ drain grid, stainless steel, round



Description	Diameter × Height	Packing unit	Order no.
Fundo Fino 3.2, drain grid, round, stainless steel	Ø 115 × 5 mm	1 unit	67-68-00/041

-  ▪ 1 drain grid

Fundo Fino 3.3 ▪ drain grid, stainless steel, square, screw in



Description	Length × Width × Height	Packing unit	Order no.
Fundo Fino 3.3, drain grid, square, stainless steel, screw in, incl. stainless steel frames	115 × 115 × 5 mm	1 unit	67-68-00/042

! For this drain grid, the height of your tiling must be at least 8.5 mm.

-  ▪ 1 drain grid
- 1 frame
- 2 stainless steel screws

Fundo Fino 4.1 ▪ drain grid, solid stainless steel, square



Description	Length × Width × Height	Packing unit	Order no.
Fundo Fino 4.1, drain grid, square, solid stainless steel	115 × 115 × 5 mm	1 unit	67-68-00/043

-  ▪ 1 drain grid
- 1 plastic frame

Manufactured in solid stainless steel

07

08

09

10



11

12



13

14





Fundo Fino 4.2 ▪ drain grid, solid stainless steel, round

 <p>Manufactured in solid stainless steel</p>	Description	Diameter × Height	Packing unit	Order no.
	Fundo Fino 4.2, drain grid, round, solid stainless steel	Ø 115 × 5 mm	1 unit	67-68-00/044
 1 drain grid				

Fundo Fino 5.1 ▪ drain grid, solid stainless steel, square



 <p>Manufactured in solid stainless steel</p>	Description	Length × Width × Height	Packing unit	Order no.
	Fundo Fino 5.1, drain grid, square, solid stainless steel	115 × 115 × 5 mm	1 unit	67-68-00/046
 1 drain grid  1 plastic frame				

Fundo Fino 6.1 ▪ flat drain grid with frame, solid stainless steel, square



 <p>Manufactured in solid stainless steel</p>	Description	Length × Width × Height	Packing unit	Order no.
	Fundo Fino 6.1, flat drain grid, square, solid stainless steel, incl. plastic frame	115 × 115 × 2,5 mm	1 unit	67-68-00/052
 Also suitable for flat ceramic coverings and glass mosaics.				
 1 drain grid  1 plastic frame				

 Fundo Fino drain grids can also be combined with Fundo Integro. For this purpose, the receptacle PVC frame of Fundo Fino must be used.



Fundo Fino ▪ frame, stainless steel, square

	Description	Length × Width × Height	Packing unit	Order no.
	Fundo Fino, frame, stainless steel	120 × 120 × 10 mm	1 unit	07-71-00/003
<p>! For this frame, the height of your tiling must be at least 8.5 mm.</p> <ul style="list-style-type: none"> • Suitable for any square Fundo Fino drain grate. • Not suitable for Fundo Integro. 		<p> 1 frame</p>		



Fundo Fino ▪ frame, stainless steel, square, extra flat

	Description	Length × Width × Height	Packing unit	Order no.
	Fundo Fino, frame, stainless steel, extra flat	120 × 120 × 6,2 mm	1 unit	07-71-00/004
<p>! For this frame, the height of your tiling must be at least 6.2 mm.</p> <ul style="list-style-type: none"> • Suitable for any square Fundo Fino drain grate. • Not suitable for Fundo Integro. 		<p> 1 frame</p>		

Fundo Fino ▪ frame, stainless steel, round

	Description	Diameter × Height	Packing unit	Order no.
	Fundo Fino, frame, stainless steel, round	Ø 120 × 9 mm	1 unit	07-71-00/001
<p>! For this frame, the height of your tiling must be at least 8.5 mm.</p> <ul style="list-style-type: none"> • Suitable for any round Fundo Fino drain grate. • Not suitable for Fundo Integro. 		<p> 1 frame</p>		

Fundo Fino ▪ frame, stainless steel, round, extra flat

	Description	Diameter × Height	Packing unit	Order no.
	Fundo Fino, frame, stainless steel, round, extra flat	Ø 120 × 2 mm	1 unit	07-71-00/002
<p>! For this frame, the height of your tiling must be at least 2 mm.</p> <ul style="list-style-type: none"> • Frame can be raised with mortar up to 5 mm. • Suitable for any round Fundo Fino drain grate. • Not suitable for Fundo Integro. 		<p> 1 frame</p>		

07

08

09

10

11

12

13

14

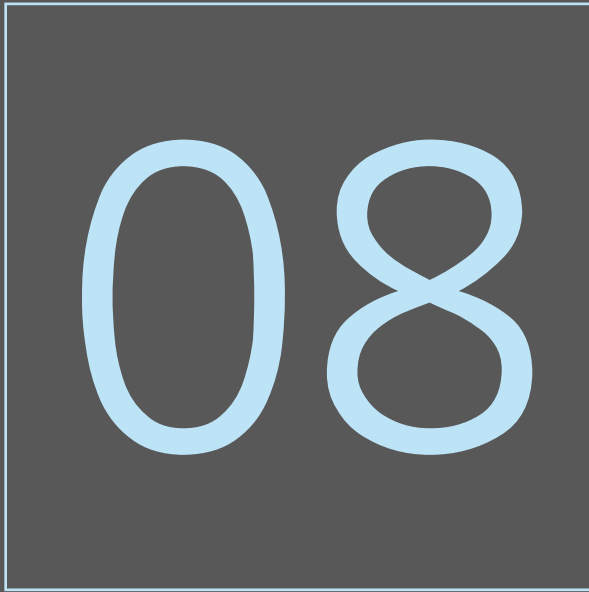

Linear drainage

Stylish. Modern. Elegant. Showers with linear drainage are a visual highlight and have become a main desired feature for the modern bathroom. wedi offers high-quality linear drainage systems, which come with either lateral or central drainage channels. The necessary slope for rapid and efficient water drainage is already integrated here. The choice of channel covers made of high-quality stainless steel complete the shower system and give your bathroom its very own character.



Don't forget: Matching accessories

- wedi 610 ▪ adhesive and sealant for waterproof adhesion of joints within the wedi system
- wedi Tools sealing tape ▪ for watertight connection to non-system materials
- wedi Fundo sealing set ▪ for all-round sealing of Fundo floor elements to adjacent materials, e.g. screed
- wedi Fundo drains ▪ horizontal/vertical drains for flush-to-floor showers with linear drainage
- wedi channel covers ▪ High-quality channel covers for linear drainage
- wedi Fundo slope profiles ▪ for an aesthetically pleasing transition to the adjoining tiled floors

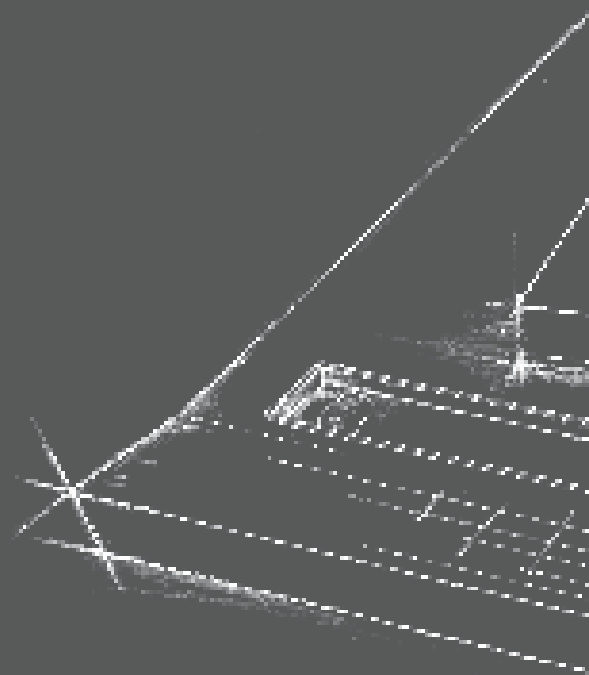

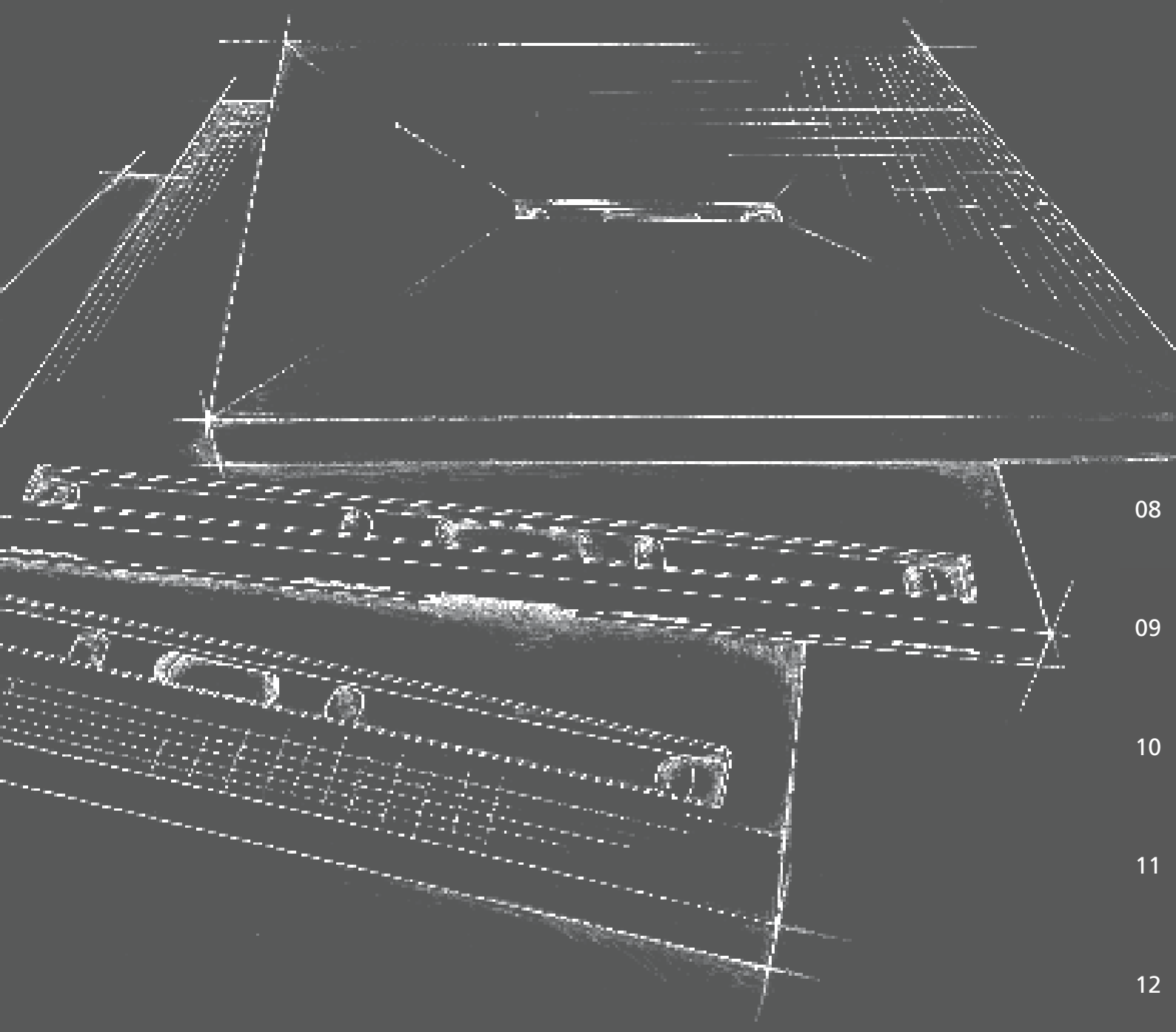

08

09

10

11

12

13

14

Fundo Riolito ▪ floor element, square

	Description	Length × Width × Height	Channel length	Packing unit/Pallet	Order no.
	Fundo Riolito, floor element with channel drain	900 × 900 × 50 mm	300 mm	10 units	07-37-37/307
	Fundo Riolito, floor element with channel drain	900 × 900 × 50 mm	800 mm ②	10 units	07-37-37/303
	Fundo Riolito, floor element with channel drain	1000 × 1000 × 50 mm	800 mm ②	10 units	07-37-37/308
	Fundo Riolito, floor element with channel drain	1200 × 1200 × 50 mm	1100 mm	10 units	07-37-37/304

Now available with new wedi channel drain technology

- ! One packing unit = 10 pieces; piece acceptance possible!
- For Fundo Riolito / Riolito neo and Riofino only Fundo linear drain systems by wedi can be used.

- 👉 You can order the Fundo Discreto element for an optical wall drain as an optional feature.
- The figures ①, ② and ③ mark the matching combinations with Fundo Discreto.

i The technical drawing for this product can be found in Chapter 14, Technology on Page 150.

- 👑 ▪ 1 Fundo Riolito floor element
- 2 frame clamping pieces

Fundo Riolito ▪ floor element, rectangular

	Description	Length × Width × Height	Channel length	Packing unit/Pallet	Order no.
	Fundo Riolito, floor element with channel drain	1200 × 800 × 50 mm	700 mm ①	10 units	07-37-37/301
	Fundo Riolito, floor element with channel drain	1200 × 900 × 50 mm	800 mm ②	10 units	07-37-37/305
	Fundo Riolito, floor element with channel drain	1200 × 1000 × 50 mm	900 mm ③	10 units	07-37-37/302
	Fundo Riolito, floor element with channel drain	1400 × 900 × 50 mm	700 mm ①	10 units	07-37-37/309
	Fundo Riolito, floor element with channel drain	1600 × 1000 × 50 mm	800 mm ②	10 units	07-37-37/310
	Fundo Riolito, floor element with channel drain	1800 × 900 × 60 mm	800 mm ②	10 units	07-37-37/306

Now available with new wedi channel drain technology

- ! One packing unit = 10 pieces; piece acceptance possible!
- For Fundo Riolito / Riolito neo and Riofino only Fundo linear drain systems by wedi can be used.

- 👉 You can order the Fundo Discreto element for an optical wall drain as an optional feature.
- The figures ①, ② and ③ mark the matching combinations with Fundo Discreto.

i The technical drawing for this product can be found in Chapter 14, Technology on Page 150.

- 👑 ▪ 1 Fundo Riolito floor element
- 2 frame clamping pieces

Fundo Riolito ▪ slope wedge, left-hand version, stainless steel V₂A

	Description	Thickness	Length	Packing unit/box	Order no.
	Fundo Riolito, slope wedge, left-hand version, stainless steel V ₂ A brushed	8,0 mm	1200 mm	1 unit	10-61-00/008
	Fundo Riolito, slope wedge, left-hand version, stainless steel V ₂ A brushed	10,0 mm	1200 mm	1 unit	10-61-00/010
	NEW Fundo Riolito, slope wedge, left-hand version, stainless steel V ₂ A brushed	11,0 mm	1200 mm	1 unit	10-61-00/011
	Fundo Riolito, slope wedge, left-hand version, stainless steel V ₂ A brushed	12,5 mm	1200 mm	1 unit	10-61-00/012
	Fundo Riolito, slope wedge, left-hand version, stainless steel V ₂ A brushed	8,0 mm	1600 mm	1 unit	10-63-00/008
	Fundo Riolito, slope wedge, left-hand version, stainless steel V ₂ A brushed	10,0 mm	1600 mm	1 unit	10-63-00/010
	NEW Fundo Riolito, slope wedge, left-hand version, stainless steel V ₂ A brushed	11,0 mm	1600 mm	1 unit	10-63-00/011
	Fundo Riolito, slope wedge, left-hand version, stainless steel V ₂ A brushed	12,5 mm	1600 mm	1 unit	10-63-00/012
	Fundo Riolito, slope wedge, left-hand version, stainless steel V ₂ A brushed	8,0 mm	1800 mm	1 unit	10-65-00/008
	Fundo Riolito, slope wedge, left-hand version, stainless steel V ₂ A brushed	10,0 mm	1800 mm	1 unit	10-65-00/010
	NEW Fundo Riolito, slope wedge, left-hand version, stainless steel V ₂ A brushed	11,0 mm	1800 mm	1 unit	10-65-00/011
	Fundo Riolito, slope wedge, left-hand version, stainless steel V ₂ A brushed	12,5 mm	1800 mm	1 unit	10-65-00/012

- i** ▪ This profile is suitable for all Fundo Riolito floor elements.
It is not suitable for Fundo Riolito neo floor elements.
- The slope profile can be individually reduced (length: 1600 mm by max. 400 mm, all other lengths by max. 300 mm).
 - The technical drawings for these products can be found in Chapter 14, Technology on Page 151.



08

09

10

11

12

13

14

Fundo Riolito ▪ slope wedge, right-hand version, stainless steel V₂A

	Description	Thickness	Length	Packing unit/box	Order no.
	Fundo Riolito, slope wedge, right-hand version, stainless steel V ₂ A brushed	8,0 mm	1200 mm	1 unit	10-61-10/008
	Fundo Riolito, slope wedge, right-hand version, stainless steel V ₂ A brushed	10,0 mm	1200 mm	1 unit	10-61-10/010
	NEW Fundo Riolito, slope wedge, right-hand version, stainless steel V ₂ A brushed	11,0 mm	1200 mm	1 unit	10-61-10/011
	Fundo Riolito, slope wedge, right-hand version, stainless steel V ₂ A brushed	12,5 mm	1200 mm	1 unit	10-61-10/012
	Fundo Riolito, slope wedge, right-hand version, stainless steel V ₂ A brushed	8,0 mm	1600 mm	1 unit	10-63-10/008
	Fundo Riolito, slope wedge, right-hand version, stainless steel V ₂ A brushed	10,0 mm	1600 mm	1 unit	10-63-10/010
	NEW Fundo Riolito, slope wedge, right-hand version, stainless steel V ₂ A brushed	11,0 mm	1600 mm	1 unit	10-63-10/011
	Fundo Riolito, slope wedge, right-hand version, stainless steel V ₂ A brushed	12,5 mm	1600 mm	1 unit	10-63-10/012
	Fundo Riolito, slope wedge, right-hand version, stainless steel V ₂ A brushed	8,0 mm	1800 mm	1 unit	10-65-10/008
	Fundo Riolito, slope wedge, right-hand version, stainless steel V ₂ A brushed	10,0 mm	1800 mm	1 unit	10-65-10/010
	NEW Fundo Riolito, slope wedge, right-hand version, stainless steel V ₂ A brushed	11,0 mm	1800 mm	1 unit	10-65-10/011
	Fundo Riolito, slope wedge, right-hand version, stainless steel V ₂ A brushed	12,5 mm	1800 mm	1 unit	10-65-10/012

- i** ▪ This profile is suitable for all Fundo Riolito floor elements.
It is not suitable for Fundo Riolito neo floor elements.
- The slope profile can be individually reduced (length: 1600 mm by max. 400 mm, all other lengths by max. 300 mm).
- The technical drawings for these products can be found in Chapter 14, Technology on Page 151.



Fundo Riolito ▪ slope profile wall, left-hand version, stainless steel V₂A

	Description	Thickness	Length	Packing unit/box	Order no.
	Fundo Riolito, slope profile wall, left-hand version, stainless steel V ₂ A brushed	8,0 mm	1200 mm	1 unit	10-62-00/008
	Fundo Riolito, slope profile wall, left-hand version, stainless steel V ₂ A brushed	10,0 mm	1200 mm	1 unit	10-62-00/010
	NEW Fundo Riolito, slope profile wall, left-hand version, stainless steel V ₂ A brushed	11,0 mm	1200 mm	1 unit	10-62-00/011
	Fundo Riolito, slope profile wall, left-hand version, stainless steel V ₂ A brushed	12,5 mm	1200 mm	1 unit	10-62-00/012
	Fundo Riolito, slope profile wall, left-hand version, stainless steel V ₂ A brushed	8,0 mm	1600 mm	1 unit	10-64-00/008
	Fundo Riolito, slope profile wall, left-hand version, stainless steel V ₂ A brushed	10,0 mm	1600 mm	1 unit	10-64-00/010
	NEW Fundo Riolito, slope profile wall, left-hand version, stainless steel V ₂ A brushed	11,0 mm	1600 mm	1 unit	10-64-00/011
	Fundo Riolito, slope profile wall, left-hand version, stainless steel V ₂ A brushed	12,5 mm	1600 mm	1 unit	10-64-00/012
	Fundo Riolito, slope profile wall, left-hand version, stainless steel V ₂ A brushed	8,0 mm	1800 mm	1 unit	10-66-00/008
	Fundo Riolito, slope profile wall, left-hand version, stainless steel V ₂ A brushed	10,0 mm	1800 mm	1 unit	10-66-00/010
	NEW Fundo Riolito, slope profile wall, left-hand version, stainless steel V ₂ A brushed	11,0 mm	1800 mm	1 unit	10-66-00/011
	Fundo Riolito, slope profile wall, left-hand version, stainless steel V ₂ A brushed	12,5 mm	1800 mm	1 unit	10-66-00/012

i ▪ This profile is suitable for all Fundo Riolito floor elements.

It is not suitable for Fundo Riolito neo floor elements.

- The slope profile can be individually reduced (length: 1600 mm by max. 400 mm, all other lengths by max. 300 mm).
- The technical drawings for these products can be found in Chapter 14, Technology on Page 151.

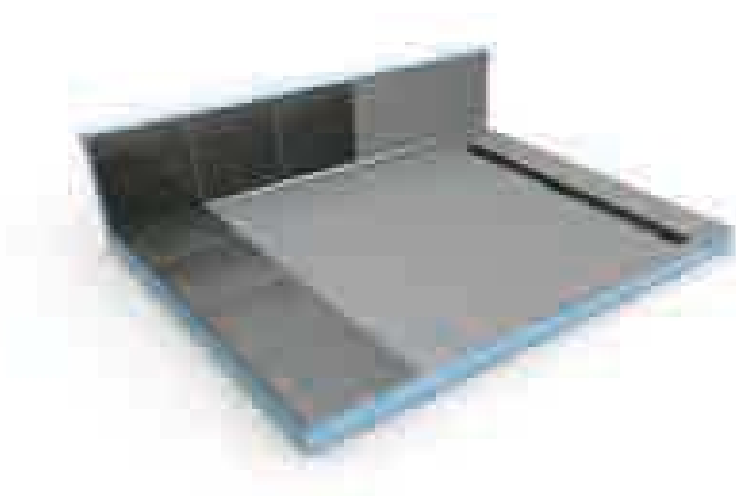

08

09

10

11

12

13

14



Fundo Riolito ▪ slope profile wall, right-hand version, stainless steel V₂A

	Description	Thickness	Length	Packing unit/box	Order no.
	Fundo Riolito, slope profile wall, right-hand version, stainless steel V ₂ A brushed	8,0 mm	1200 mm	1 unit	10-62-10/008
	Fundo Riolito, slope profile wall, right-hand version, stainless steel V ₂ A brushed	10,0 mm	1200 mm	1 unit	10-62-10/010
	NEW Fundo Riolito, slope profile wall, right-hand version, stainless steel V ₂ A brushed	11,0 mm	1200 mm	1 unit	10-62-10/011
	Fundo Riolito, slope profile wall, right-hand version, stainless steel V ₂ A brushed	12,5 mm	1200 mm	1 unit	10-62-10/012
	Fundo Riolito, slope profile wall, right-hand version, stainless steel V ₂ A brushed	8,0 mm	1600 mm	1 unit	10-64-10/008
	Fundo Riolito, slope profile wall, right-hand version, stainless steel V ₂ A brushed	10,0 mm	1600 mm	1 unit	10-64-10/010
	NEW Fundo Riolito, slope profile wall, right-hand version, stainless steel V ₂ A brushed	11,0 mm	1600 mm	1 unit	10-64-10/011
	Fundo Riolito, slope profile wall, right-hand version, stainless steel V ₂ A brushed	12,5 mm	1600 mm	1 unit	10-64-10/012
	Fundo Riolito, slope profile wall, right-hand version, stainless steel V ₂ A brushed	8,0 mm	1800 mm	1 unit	10-66-10/008
	Fundo Riolito, slope profile wall, right-hand version, stainless steel V ₂ A brushed	10,0 mm	1800 mm	1 unit	10-66-10/010
	NEW Fundo Riolito, slope profile wall, right-hand version, stainless steel V ₂ A brushed	11,0 mm	1800 mm	1 unit	10-66-10/011
	Fundo Riolito, slope profile wall, right-hand version, stainless steel V ₂ A brushed	12,5 mm	1800 mm	1 unit	10-66-10/012

- i** ▪ This profile is suitable for all Fundo Riolito floor elements.
It is not suitable for Fundo Riolito neo floor elements.
- The slope profile can be individually reduced (length: 1600 mm by max. 400 mm, all other lengths by max. 300 mm).
- The technical drawings for these products can be found in Chapter 14, Technology on Page 151.



Fundo Riolito neo ▪ floor element, square

	Description	Length × Width × Height	Channel length	Packing unit/Pallet	Order no.
	Fundo Riolito neo, floor element with channel drain, square	900 × 900 × 50 mm	800 mm ②	10 units	07-51-00/003
	Fundo Riolito neo, floor element with channel drain, square	1000 × 1000 × 50 mm	800 mm ②	10 units	07-51-00/032
	Fundo Riolito neo, floor element with channel drain, square	1200 × 1200 × 50 mm	1100 mm	10 units	07-51-00/010
	Fundo Riolito neo, floor element with channel drain, square	900 × 900 × 50 mm	300 mm	10 units	07-51-00/031
	<p>! • One packing unit = 10 pieces; piece acceptance possible! • For Fundo Riolito / Riolito neo and Riofino only Fundo linear drain systems by wedi can be used.</p> <p>+ • You can order the Fundo Discreto element for an optical wall drain as an optional feature. • The figures ①, ② and ③ mark the matching combinations with Fundo Discreto.</p> <p>i The technical drawings for these products can be found in Chapter 14, Technology on Page 152.</p>				
<p>Please note: Order the matching drain and cover channel!</p>		<p>+ • 1 Fundo Riolito neo floor element • 2 frame clamping pieces</p>			

Fundo Riolito neo ▪ floor element, rectangular

	Description	Length × Width × Height	Channel length	Packing unit/Pallet	Order no.
	Fundo Riolito neo, floor element with channel drain, rectangular	1200 × 800 × 50 mm	700 mm ①	10 units	07-51-00/001
	Fundo Riolito neo, floor element with channel drain, rectangular	1400 × 900 × 50 mm	700 mm ①	10 units	07-51-00/033
	Fundo Riolito neo, floor element with channel drain, rectangular	1200 × 900 × 50 mm	800 mm ②	10 units	07-51-00/004
	Fundo Riolito neo, floor element with channel drain, rectangular	1800 × 900 × 60 mm	800 mm ②	10 units	07-51-00/005
	Fundo Riolito neo, floor element with channel drain, rectangular	1600 × 1000 × 50 mm	800 mm ②	10 units	07-51-00/034
<p>Please note: Order the matching drain and cover channel!</p>	Fundo Riolito neo, floor element with channel drain, rectangular	1200 × 1000 × 50 mm	900 mm ③	10 units	07-51-00/008

- !** • One packing unit = 10 pieces; piece acceptance possible!
 • For Fundo Riolito / Riolito neo and Riofino only Fundo linear drain systems by wedi can be used.
 - +** • You can order the Fundo Discreto element for an optical wall drain as an optional feature.
 • The figures ①, ② and ③ mark the matching combinations with Fundo Discreto.
 - i** The technical drawings for these products can be found in Chapter 14, Technology on Page 152.
- +** • 1 Fundo Riolito neo floor element
 • 2 frame clamping pieces

08

09

10

11

12

13

14

Fundo Riolito neo / Plano Linea slope profile ▪ floor, left, stainless steel V₂A

	Description	Thickness	Length	Packing unit/box	Order no.
	Fundo Riolito neo / Plano Linea slope profile, left-hand version, stainless steel V ₂ A	8.0 mm	1200 mm	1 unit	10-71-00/008
	Fundo Riolito neo / Plano Linea slope profile, left-hand version, stainless steel V ₂ A	10.0 mm	1200 mm	1 unit	10-71-00/010
	NEW Fundo Riolito neo / Plano Linea slope profile, left-hand version, stainless steel V ₂ A	11,0 mm	1200 mm	1 unit	10-71-00/011
	Fundo Riolito neo / Plano Linea slope profile, left-hand version, stainless steel V ₂ A	12.5 mm	1200 mm	1 unit	10-71-00/012
	Fundo Riolito neo / Plano Linea slope profile, left-hand version, stainless steel V ₂ A	8.0 mm	1600 mm	1 unit	10-81-20/008
	Fundo Riolito neo / Plano Linea slope profile, left-hand version, stainless steel V ₂ A	10.0 mm	1600 mm	1 unit	10-81-20/010
	NEW Fundo Riolito neo / Plano Linea slope profile, left-hand version, stainless steel V ₂ A	11,0 mm	1600 mm	1 unit	10-81-20/011
	Fundo Riolito neo / Plano Linea slope profile, left-hand version, stainless steel V ₂ A	12.5 mm	1600 mm	1 unit	10-81-20/012
	Fundo Riolito neo / Plano Linea slope profile, left-hand version, stainless steel V ₂ A	8.0 mm	1800 mm	1 unit	10-81-40/008
	Fundo Riolito neo / Plano Linea slope profile, left-hand version, stainless steel V ₂ A	10.0 mm	1800 mm	1 unit	10-81-40/010
	NEW Fundo Riolito neo / Plano Linea slope profile, left-hand version, stainless steel V ₂ A	11,0 mm	1800 mm	1 unit	10-81-40/011
	Fundo Riolito neo / Plano Linea slope profile, left-hand version, stainless steel V ₂ A	12.5 mm	1800 mm	1 unit	10-81-40/012

- i** ▪ Fits: Fundo Riolito neo / Plano Linea floor elements
 - The slope profile can be individually reduced (length: 1600 mm by max. 400 mm, all other lengths by max. 300 mm).
 - The technical drawings for these products can be found in Chapter 14, Technology on Page 153.



Fundo Riolito neo / Plano Linea slope profile ▪ floor, right, stainless steel V₂A

	Description	Thickness	Length	Packing unit/box	Order no.
	Fundo Riolito neo / Plano Linea slope profile, right-hand version, stainless steel V ₂ A	8.0 mm	1200 mm	1 unit	10-71-10/008
	Fundo Riolito neo / Plano Linea slope profile, right-hand version, stainless steel V ₂ A	10.0 mm	1200 mm	1 unit	10-71-10/010
	NEW Fundo Riolito neo / Plano Linea slope profile, right-hand version, stainless steel V ₂ A	11,0 mm	1200 mm	1 unit	10-71-10/011
	Fundo Riolito neo / Plano Linea slope profile, right-hand version, stainless steel V ₂ A	12.5 mm	1200 mm	1 unit	10-71-10/012
	Fundo Riolito neo / Plano Linea slope profile, right-hand version, stainless steel V ₂ A	8.0 mm	1600 mm	1 unit	10-81-30/008
	Fundo Riolito neo / Plano Linea slope profile, right-hand version, stainless steel V ₂ A	10.0 mm	1600 mm	1 unit	10-81-30/010
	NEW Fundo Riolito neo / Plano Linea slope profile, right-hand version, stainless steel V ₂ A	11,0 mm	1600 mm	1 unit	10-81-30/011
	Fundo Riolito neo / Plano Linea slope profile, right-hand version, stainless steel V ₂ A	12.5 mm	1600 mm	1 unit	10-81-30/012
	Fundo Riolito neo / Plano Linea slope profile, right-hand version, stainless steel V ₂ A	8.0 mm	1800 mm	1 unit	10-81-50/008
	Fundo Riolito neo / Plano Linea slope profile, right-hand version, stainless steel V ₂ A	10.0 mm	1800 mm	1 unit	10-81-50/010
	NEW Fundo Riolito neo / Plano Linea slope profile, right-hand version, stainless steel V ₂ A	11,0 mm	1800 mm	1 unit	10-81-50/011
	Fundo Riolito neo / Plano Linea slope profile, right-hand version, stainless steel V ₂ A	12.5 mm	1800 mm	1 unit	10-81-50/012

- i** ▪ Fits: Fundo Riolito neo / Plano Linea floor elements
- The slope profile can be individually reduced (length: 1600 mm by max. 400 mm, all other lengths by max. 300 mm).
 - The technical drawings for these products can be found in Chapter 14, Technology on Page 153.

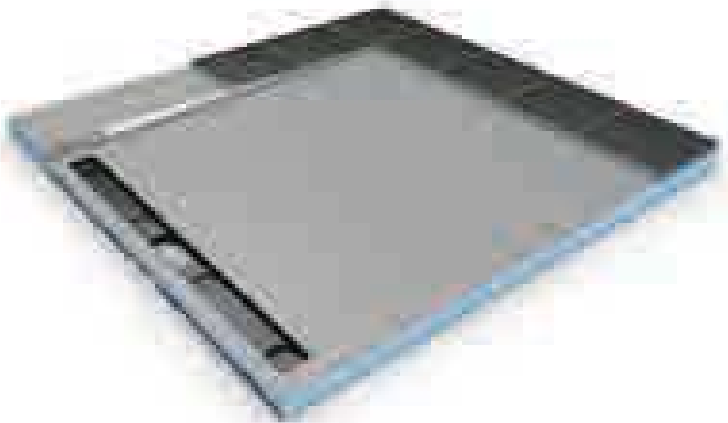

08

09

10

11

12

13

14

Fundo Riolito neo / Plano Linea slope profile ▪ wall, left, stainless steel V₂A

	Description	Thickness	Length	Packing unit/box	Order no.
	Fundo Riolitoneo / Plano Linea slope profile wall, left-hand version, stainless steel V ₂ A	8.0 mm	1200 mm	1 unit	10-72-00/008
	Fundo Riolitoneo / Plano Linea slope profile wall, left-hand version, stainless steel V ₂ A	10.0 mm	1200 mm	1 unit	10-72-00/010
	NEW Fundo Riolitoneo / Plano Linea slope profile wall, left-hand version, stainless steel V ₂ A	11,0 mm	1200 mm	1 unit	10-72-00/011
	Fundo Riolitoneo / Plano Linea slope profile wall, left-hand version, stainless steel V ₂ A	12.5 mm	1200 mm	1 unit	10-72-00/012
	Fundo Riolitoneo / Plano Linea slope profile wall, left-hand version, stainless steel V ₂ A	8.0 mm	1600 mm	1 unit	10-82-20/008
	Fundo Riolitoneo / Plano Linea slope profile wall, left-hand version, stainless steel V ₂ A	10.0 mm	1600 mm	1 unit	10-82-20/010
	NEW Fundo Riolitoneo / Plano Linea slope profile wall, left-hand version, stainless steel V ₂ A	11,0 mm	1600 mm	1 unit	10-82-20/011
	Fundo Riolitoneo / Plano Linea slope profile wall, left-hand version, stainless steel V ₂ A	12.5 mm	1600 mm	1 unit	10-82-20/012
	Fundo Riolitoneo / Plano Linea slope profile wall, left-hand version, stainless steel V ₂ A	8.0 mm	1800 mm	1 unit	10-82-40/008
	Fundo Riolitoneo / Plano Linea slope profile wall, left-hand version, stainless steel V ₂ A	10.0 mm	1800 mm	1 unit	10-82-40/010
	NEW Fundo Riolitoneo / Plano Linea slope profile wall, left-hand version, stainless steel V ₂ A	11,0 mm	1800 mm	1 unit	10-82-40/011
	Fundo Riolitoneo / Plano Linea slope profile wall, left-hand version, stainless steel V ₂ A	12.5 mm	1800 mm	1 unit	10-82-40/012

- i** ▪ Fits: Fundo Riolito neo / Plano Linea floor elements
- The slope profile can be individually reduced (length: 1600 mm by max. 400 mm, all other lengths by max. 300 mm).
- The technical drawings for these products can be found in Chapter 14, Technology on Page 153.

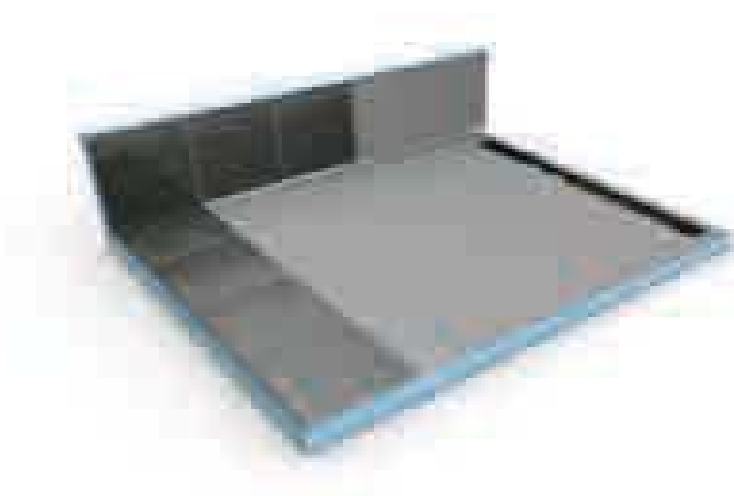

Fundo Riolito neo / Plano Linea slope profile ▪ wall, right, stainless steel V₂A

	Description	Thickness	Length	Packing unit/box	Order no.
	Fundo Riolitoneo / Plano Linea slope profile wall, right-hand version, stainless steel V ₂ A	8.0 mm	1200 mm	1 unit	10-72-10/008
	Fundo Riolitoneo / Plano Linea slope profile wall, right-hand version, stainless steel V ₂ A	10.0 mm	1200 mm	1 unit	10-72-10/010
	NEW Fundo Riolitoneo / Plano Linea slope profile wall, right-hand version, stainless steel V ₂ A	11,0 mm	1200 mm	1 unit	10-72-10/011
	Fundo Riolitoneo / Plano Linea slope profile wall, right-hand version, stainless steel V ₂ A	12.5 mm	1200 mm	1 unit	10-72-10/012
	Fundo Riolitoneo / Plano Linea slope profile wall, right-hand version, stainless steel V ₂ A	8.0 mm	1600 mm	1 unit	10-82-30/008
	Fundo Riolitoneo / Plano Linea slope profile wall, right-hand version, stainless steel V ₂ A	10.0 mm	1600 mm	1 unit	10-82-30/010
	NEW Fundo Riolitoneo / Plano Linea slope profile wall, right-hand version, stainless steel V ₂ A	11,0 mm	1600 mm	1 unit	10-82-30/011
	Fundo Riolitoneo / Plano Linea slope profile wall, right-hand version, stainless steel V ₂ A	12.5 mm	1600 mm	1 unit	10-82-30/012
	Fundo Riolitoneo / Plano Linea slope profile wall, right-hand version, stainless steel V ₂ A	8.0 mm	1800 mm	1 unit	10-82-50/008
	Fundo Riolitoneo / Plano Linea slope profile wall, right-hand version, stainless steel V ₂ A	10.0 mm	1800 mm	1 unit	10-82-50/010
	NEW Fundo Riolitoneo / Plano Linea slope profile wall, right-hand version, stainless steel V ₂ A	11,0 mm	1800 mm	1 unit	10-82-50/011
	Fundo Riolitoneo / Plano Linea slope profile wall, right-hand version, stainless steel V ₂ A	12.5 mm	1800 mm	1 unit	10-82-50/012

- i** ▪ Fits: Fundo Riolitoneo / Plano Linea floor elements
- The slope profile can be individually reduced (length: 1600 mm by max. 400 mm, all other lengths by max. 300 mm).
 - The technical drawings for these products can be found in Chapter 14, Technology on Page 153.



08

09

10

11

12

13

14

Fundo Riolito neo / Plano Linea end profile ▪ stainless steel V₂A

	Description	Length × Height	Packing unit/box	Order no.
	Fundo Riolito neo / Plano Linea end profile, stainless steel V ₂ A brushed	1000 × 21 mm	1 unit	10-73-00/001
	Fundo Riolito neo / Plano Linea end profile, stainless steel V ₂ A brushed	1200 × 21 mm	1 unit	10-81-00/001

i The technical drawing for this product can be found in Chapter 14, Technology on Page 154.

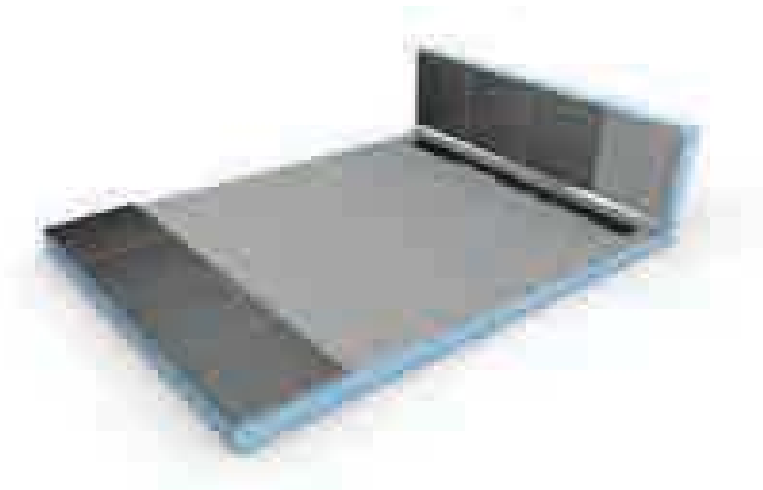

Fundo Riofino ▪ floor element, square

	Description	Length × Width × Height	Channel length	Packing unit/Pallet	Order no.
	Fundo Riofino, floor element with central channel drain	900 × 900 × 50 mm	300 mm	10 units	07-37-37/312
	Fundo Riofino, floor element with central channel drain	1000 × 1000 × 50 mm	300 mm	10 units	07-37-37/311
	Fundo Riofino, floor element with central channel drain	1200 × 1200 × 50 mm	300 mm	10 units	07-37-37/313

- !** ▪ One packing unit = 10 pieces; piece acceptance possible!
- For Fundo Riolito / Riolito neo and Riofino only Fundo linear drain systems by wedi can be used.

- 👑** ▪ 1 Fundo Riofino floor element
- 1 frame clamping piece

i The technical drawing for this product can be found in Chapter 14, Technology on Page 154.

Now available
with new wedi channel
drain technology

Fundo Riofino ▪ floor element, rectangular

	Description	Length × Width × Height	Channel length	Packing unit/Pallet	Order no.
	Fundo Riofino, floor element with central channel drain	1200 × 900 × 50 mm	300 mm	10 units	07-37-37/314
Fundo Riofino, floor element with central channel drain	1800 × 900 × 50 mm	300 mm	10 units	07-37-37/315	

! • One packing unit = 10 pieces; piece acceptance possible!

• For Fundo Riolito / Riolito neo and Riofino only Fundo linear drain systems by wedi can be used.

i The technical drawing for this product can be found in Chapter 14, Technology on Page 154.

🔧 • 1 Fundo Riofino floor element

• 1 frame clamping piece

Now available with new wedi channel drain technology

wedi Fundo special floor element ▪ with linear drainage

	Description	Dimensions	Restrictions	Order no.
	wedi Fundo special floor element, with 300 mm central channel drain, square, rectangular, one piece	Length X: max. 1800 mm Width Y: max. 1500 mm Thickness: 50 mm	Technical feasibility check is required	07-37-16/299

! • Delivery can take approximately 7 days after receipt of order and confirmation of technical specification. (Only applies to orders of 1 to 3 units; larger numbers of units require an individual check)

• The drains and channel covers for special floor elements must be ordered separately.

i • The technical drawings for these products can be found in Chapter 14, Technology on Page 155.

• Drains can be positioned wherever you like (considering the specified minimum distance) for all individual designs.

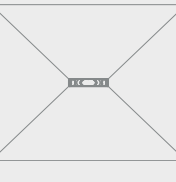

08

wedi Fundo special floor element ▪ with linear drainage

	Description	Dimensions	Restrictions	Order no.
	wedi Fundo special floor element with channel drain close to wall, 1-sided slope	Length X: max. 1600 mm Width Y: max. 1500 mm Thickness: 50 mm	Technical feasibility check is required	07-37-16/199
wedi Fundo special floor element with channel drain near to wall, 2-sided slope	Length X: max. 1650 mm Width Y: max. 1500 mm Thickness: 50 mm	Technical feasibility check is required	07-37-16/199	
wedi Fundo special floor element with channel drain near to wall, 4-sided slope	Length X: max. 1800 mm Width Y: max. 1500 mm Thickness: 50 mm	Technical feasibility check is required	07-37-16/199	

! • Delivery can take approximately 7 days after receipt of order and confirmation of technical specification. (Only applies to orders of 1 to 3 units; larger numbers of units require an individual check)

• The drains and channel covers for special floor elements must be ordered separately.

i • The technical drawings for these products can be found in Chapter 14, Technology on Page 155.

• These Fundo floor elements can be combined with channel lengths of 300, 700, 800, 900 and 1100 mm.

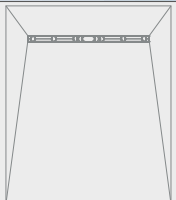

09

10

11

12

13

14

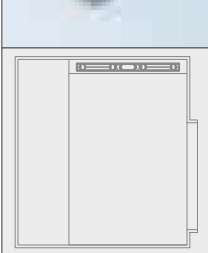

wedi Fundo special floor element ▪ with linear drainage

	Description	Dimensions	Restrictions	Order no.
	wedi Fundo special floor element, Individual, hot water heating possible	Length X: individual Width Y: individual Thickness: individual	Technical feasibility check is required	07-37-16/599
<p>! Delivery can take approximately 21 days after receipt of order and confirmation of technical specification. (Only applies to orders of 1 to 3 units; larger numbers of units require an individual check)</p> <ul style="list-style-type: none"> ▪ The drains and channel covers for special floor elements must be ordered separately. <p>i The technical drawings for these products can be found in Chapter 14, Technology on Page 156.</p> <ul style="list-style-type: none"> ▪ Drains can be positioned wherever you like (considering the specified minimum distance) for all individual designs. ▪ These Fundo floor elements can be combined with channel lengths of 300, 700, 800, 900 and 1100 mm. 				

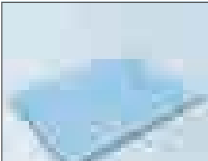
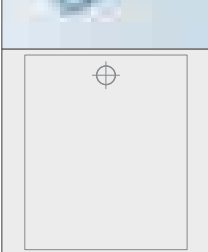

wedi Fundo substrate element ▪ special floor element for linear drainage

	Description	Dimensions	Restrictions	Order no.
	wedi Fundo substrate element, square, rectangular, one piece	Length X: max. 2400 mm Width Y: max. 1500 mm Thickness: 60 – 120 mm		07-37-14/399
<p>! Delivery can take approximately 21 days after receipt of order and confirmation of technical specification. (Only applies to orders of 1 to 3 units; larger numbers of units require an individual check)</p> <p>i The technical drawings for these products can be found in Chapter 14, Technology on Page 156.</p> <ul style="list-style-type: none"> ▪ Drains can be positioned wherever you like (considering the specified minimum distance) for all individual designs. 				



NEW wedi Fundo substrate element Individual ▪ special floor element for linear drainage

	Description	Dimensions	Restrictions	Order no.
	wedi Fundo substrate element individual, multi-corner; round; multi-piece; individual dimensions, design and thickness	Length X: individual Width Y: individual Thickness: individual		07-37-14/399
<p>! Delivery can take approximately 14 days after receipt of order and confirmation of technical specification. (Only applies to orders of 1 to 3 units; larger numbers of units require an individual check)</p> <p>i The technical drawings for these products can be found in Chapter 14, Technology on Page 156.</p>				



wedi Fundo channel drain ▪ vertical, DN 50

	Description	Packing unit	Order no.
	wedi Fundo channel drain, vertical, DN 50	1 unit	07-75-00/002
	<p>! ▪ Connection direction can be positioned freely (360°)</p> <ul style="list-style-type: none"> ▪ Core drilling diameter: 120 mm ▪ Absorption capacity: 1,1 Litre/Second ▪ Minimum installation depth: 50 mm <p>i ▪ The technical drawing for this product can be found in Chapter 14, Technology on Page 157.</p> <ul style="list-style-type: none"> ▪ The channel drain conforms to DIN EN 1253. 	<p>🔧 ▪ 1 x drain cover vertical, DN 50</p> <ul style="list-style-type: none"> ▪ 1 x adapter ▪ 4 x mounting screws for adapter ▪ 1 x syphon ▪ 1 x cap tool ▪ 1 x shower insert ▪ 1 x lubricant 	
<p>NEW: Only one drain system for all linear drainage systems</p>			

NEW wedi Fundo channel drain ▪ vertical, DN 50 with fire protection collar

	Description	Packing unit	Order no.
	wedi Fundo channel drain, vertical, DN 50 with fire protection collar	1 unit	07-37-49/011
	<p>! ▪ Absorption capacity: 1.1 Litre/Second</p> <ul style="list-style-type: none"> ▪ Core drilling diameter: 160 mm ▪ Minimum installation depth: 50 mm ▪ This drain is only suitable for the Fundo Riolito, Riolito neo and Riofino floor elements. <p>i ▪ The technical drawing for this product can be found in Chapter 14, Technology on Page 157.</p> <ul style="list-style-type: none"> ▪ The channel drain corresponds to DIN EN 1253. 	<p>🔧 ▪ 1 x drain cover horizontal, DN 50</p> <ul style="list-style-type: none"> ▪ 1 x fire-proofing ▪ 1 x main sealing collar ▪ 1 x syphon ▪ 1 x cap tool ▪ 1 x shower insert ▪ 1 x lubricant ▪ 4 x fixing screws 	
<p>NEW: Only one drain system for all linear drainage systems</p>			

wedi Fundo channel drain ▪ horizontal, DN 50

	Description	Packing unit	Order no.
	wedi Fundo channel drain, horizontal, DN 50	1 unit	07-75-00/001
	<p>! ▪ Connection direction can be positioned freely (360°)</p> <ul style="list-style-type: none"> ▪ Absorption capacity: 0,80 Litre/Second ▪ Minimum installation depth: 130 mm <p>i ▪ The technical drawing for this product can be found in Chapter 14, Technology on Page 157.</p> <ul style="list-style-type: none"> ▪ The channel drain conforms to DIN EN 1253. 	<p>🔧 ▪ 1 x drain cover horizontal, DN 50</p> <ul style="list-style-type: none"> ▪ 1 x adapter ▪ 4 x mounting screws for adapter ▪ 1 x syphon ▪ 1 x cap tool ▪ 1 x shower insert ▪ 1 x lubricant 	
<p>NEW: Only one drain system for all linear drainage systems</p>			

08

09

10

11

12

13

14

wedi Fundo channel drain Mini Max ▪ DN 40, extra flat

	Description	Packing unit	Order no.
	wedi Fundo channel drain Mini Max, DN 40, extra flat	1 unit	07-75-00/003
<ul style="list-style-type: none"> ! ▪ Connection direction can be positioned freely (360°) ▪ Absorption capacity: 0,50 Litre/Second ▪ Minimum installation depth: 99 mm i ▪ The technical drawing for this product can be found in Chapter 14, Technology on Page 157. ▪ The channel drain Mini Max drain is an authorised floor drain according to DIN EN 1253. 👑 ▪ 1 x drain cover horizontal, DN 40 ▪ 1 x adapter ▪ 4 x mounting screws for adapter ▪ 1 x syphon ▪ 1 x cap tool ▪ 1 x shower insert ▪ 1 x lubricant 			
NEW: Only one drain system for all linear drainage systems			

wedi Fundo channel covers standard ▪ stainless steel, brushed

	Description	Length x Width x Height	Packing unit	Order no.
NEW: Only ONE range for ALL drains	wedi Fundo channel cover standard, stainless steel, brushed	300 x 40 x 18 mm	1 unit	67-68-00/010
	wedi Fundo channel cover standard, stainless steel, brushed	700 x 40 x 18 mm	1 unit	67-68-00/009
	wedi Fundo channel cover standard, stainless steel, brushed	800 x 40 x 18 mm	1 unit	67-68-00/008
	wedi Fundo channel cover standard, stainless steel, brushed	900 x 40 x 18 mm	1 unit	67-68-00/007
	wedi Fundo channel cover standard, stainless steel, brushed	1100 x 40 x 18 mm	1 unit	67-68-00/006

- ! ▪ For installation heights of 5 to 23 mm.
- These channel drain covers are suitable for all Fundo floor elements with linear drainage.
- 👑 ▪ Channel cover, stainless steel, brushed
- 1 set of height-adjustable feet
- 2 pieces of 300 mm, pieces of 700 mm and 800 mm
- 6 pieces of 900 mm and 1100 mm

wedi Fundo channel covers exclusive ▪ solid stainless steel, brushed

	Description	Length × Width × Height	Packing unit	Order no.
	wedi Fundo channel cover exclusive, solid stainless steel, brushed	300 × 40 × 21 mm	1 unit	67-68-00/001
	wedi Fundo channel cover exclusive, solid stainless steel, brushed	700 × 40 × 21 mm	1 unit	67-68-00/002
NEW: Only ONE range for ALL drains	wedi Fundo channel cover exclusive, solid stainless steel, brushed	800 × 40 × 21 mm	1 unit	67-68-00/003
	wedi Fundo channel cover exclusive, solid stainless steel, brushed	900 × 40 × 21 mm	1 unit	67-68-00/004
	wedi Fundo channel cover exclusive, solid stainless steel, brushed	1100 × 40 × 21 mm	1 unit	67-68-00/005

- ! ▪ For installation heights of 5 to 25 mm.
- These channel drain covers are suitable for all Fundo floor elements with linear drainage.

- 👑 ▪ Channel cover, solid stainless steel, brushed
- 1 set of height-adjustable feet
- 2 pieces of 300 mm, pieces of 700 mm and 800 mm
- 6 pieces of 900 mm and 1100 mm

wedi Fundo channel covers tileable ▪ stainless steel, brushed

	Description	Length × Width × Height	Packing unit	Order no.
	wedi Fundo channel cover tileable, stainless steel, brushed	300 × 40 × 18 mm	1 unit	67-68-00/011
	wedi Fundo channel cover tileable, stainless steel, brushed	700 × 40 × 18 mm	1 unit	67-68-00/012
NEW: Only ONE range for ALL drains	wedi Fundo channel cover tileable, stainless steel, brushed	800 × 40 × 18 mm	1 unit	67-68-00/013
	wedi Fundo channel cover tileable, stainless steel, brushed	900 × 40 × 18 mm	1 unit	67-68-00/014
	wedi Fundo channel cover tileable, stainless steel, brushed	1100 × 40 × 18 mm	1 unit	67-68-00/015

- ! ▪ For installation heights of 5 to 25 mm.
- The trough depth is 11 mm.
- These channel drain covers are suitable for all Fundo floor elements with linear drainage (with the exception of the Fundo Plano Linea).

- 👑 ▪ Channel cover, stainless steel, brushed
- 1 set of height-adjustable feet
- 2 pieces of 300 mm, pieces of 700 mm and 800 mm
- 6 pieces of 900 mm and 1100 mm

08

09

10



11

12

13

14

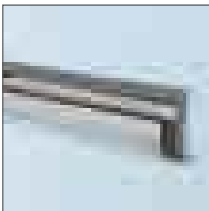
Fundo Discreto ▪ attachment element

	Description	Length x Height x Depth	fits channel length	Packing unit/Pallet	Order no.
	Fundo Discreto, attachment element	800 x 180 x 76 mm	700 mm ①	10 units	07-37-38/200
	Fundo Discreto, attachment element	900 x 180 x 76 mm	800 mm ②	10 units	07-37-38/201
	Fundo Discreto, attachment element	1000 x 180 x 76 mm	900 mm ③	10 units	07-37-38/202

-  • Fundo Discreto has been specially designed for the Fundo Riolito neo, Fundo Riolito and Fundo Plano Linea floor element.
- Numbers ①, ② and ③ are the suitable combination versions with the Fundo Riolito neo, Fundo Riolito and Fundo Plano Linea floor elements.
- The cover can be used and mounted on both sides (visible side V₂A brushed or tiled as desired).
- The technical drawings for these products can be found in Chapter 14, Technology on Page 158.

-  • Attachment element
 - wedi 610 adhesive sealant
 - V₂A cover can be used on both sides



wedi sloping board ▪ Riolito neo/Riolito/Riofino

	Description	Length x Width x Thickness	Packing unit/Pallet	Order no.
	wedi sloping board, Riolito neo/Riolito/Riofino	600 x 1200 x 50 / 60 mm	40 units	07-37-37/003

-  The technical drawing for this product can be found in Chapter 14, Technology on Page 158.

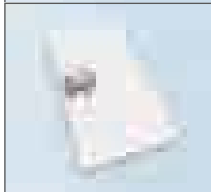



08

09

10

11

12

13

14

09

Complete systems

Floor-level showers are one of the most important customer requirements when it comes to modernising the bathroom. But the installation height is frequently restricted by local conditions, especially in existing buildings. This is why wedi developed an innovative system solution, which can be implemented irrespective of local restrictions. With the flat complete system from wedi, a floor-level shower can be reliably installed from a total assembly height of just 65 millimetres. This is because all the technical components, such as the drain, have already been integrated during production. This makes installation quicker and easier than ever.



Don't forget: Matching accessories

- wedi 610 ▪ adhesive and sealant for waterproof adhesion of joints within the wedi system
- wedi Tools sealing tape ▪ for watertight connection to non-system materials
- wedi Fundo sealing set ▪ for all-round sealing of Fundo floor elements to adjacent materials, e.g. screed
- wedi Fundo finish and slope profiles ▪ for an aesthetically pleasing transition to the adjoining tiled floors

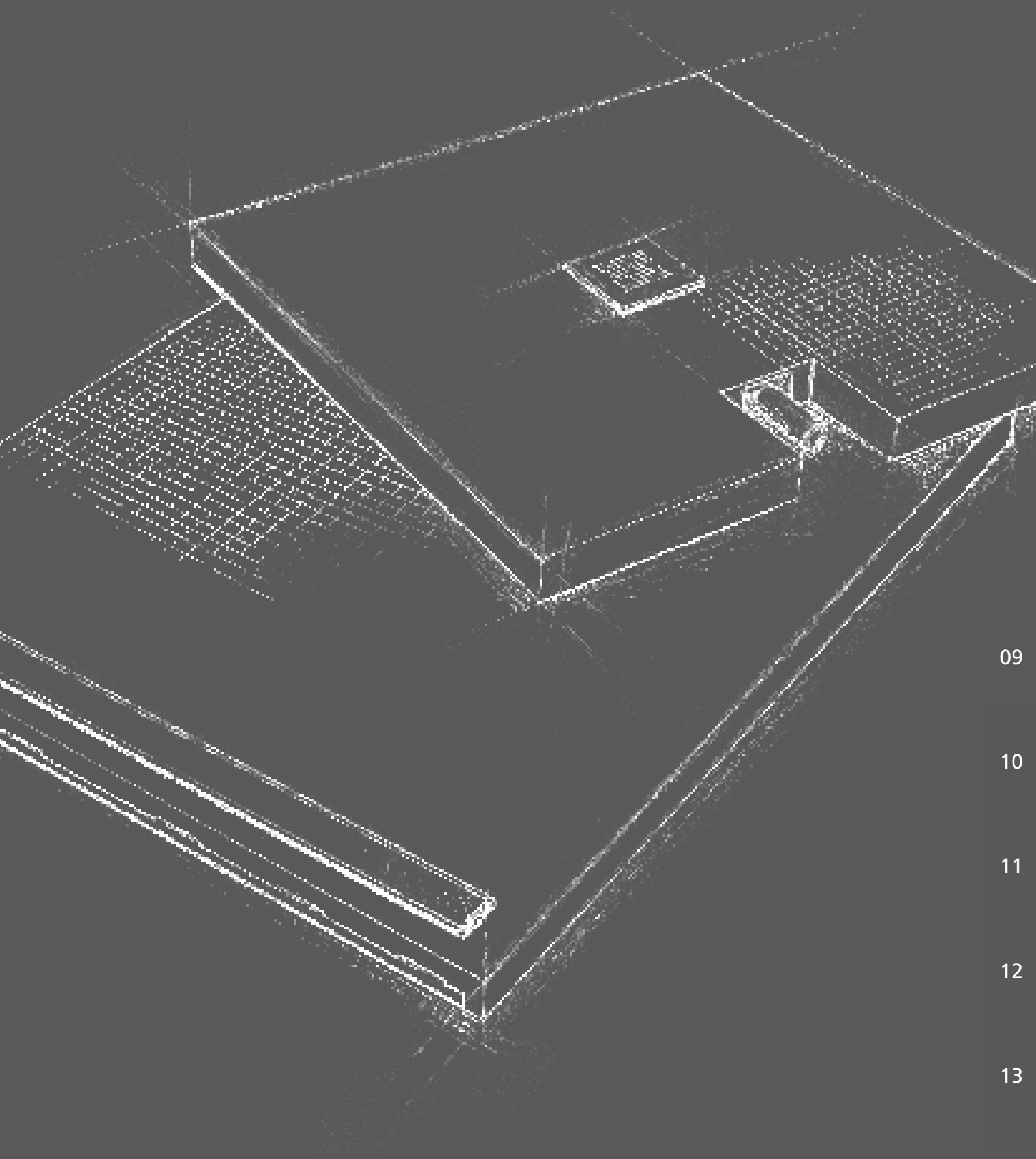

09

10

11

12

13

14



Fundo Integro ▪ Standard-compliant complete system with point drainage

	Description	DN	Length × Width × Height	Packing unit/pallet	Order no.
	Fundo Integro, floor element with fully integrated drain technology, central drain	50	900 × 900 × 90 mm	10 units	07-59-00/004
	NEW Fundo Integro, floor element with fully integrated drain technology, central drain	50	1000 × 1000 × 90 mm	10 units	07-59-00/008
	Fundo Integro, floor element with fully integrated drain technology, central drain	50	1200 × 1200 × 90 mm	10 units	07-59-00/007
	Fundo Integro, floor element with fully integrated drain technology, central drain, short side connection	50	1200 × 900 × 90 mm	10 units	07-59-00/005
	Fundo Integro, floor element with fully integrated drain technology, central drain, long side connection	50	1200 × 900 × 90 mm	10 units	07-59-00/006
	Fundo Integro, floor element with fully integrated drain technology, offset drain	50	1200 × 900 × 90 mm	10 units	07-59-00/000
	Fundo Integro, floor element with fully integrated drain technology, offset drain	50	1400 × 900 × 90 mm	10 units	07-59-00/001
	Fundo Integro, floor element with fully integrated drain technology, offset drain	50	1600 × 1000 × 90 mm	10 units	07-59-00/002
	Fundo Integro, floor element with fully integrated drain technology, offset drain	50	1800 × 900 × 90 mm	10 units	07-59-00/003



- !** ▪ One packing unit = 10 pieces; piece acceptance possible!
 - The horizontal drain DN 50 is firmly integrated in the floor element.
 - Drain capacity: 0,8 l / sek.
- 👑** ▪ A V₂A brushed stainless steel cover (115 × 115 mm), a plastic frame, a large sealing corner (800 × 800 mm) and an assembly lubricant are included in the scope of delivery for all Fundo Integro floor elements.
- i** ▪ Fundo Integro is also compatible with Fundo Fino drain covers.
 - In this case the PVC frame has to be used.
 - The technical drawings for these products can be found in Chapter 14, Technology on Page 159.

Fundo Plano ▪ flat complete system with point drainage



	Description	DN	Length × Width × Height	Packing unit/Pallet	Order no.
	Fundo Plano, floor element with fully integrated drain technology, central drain, square	40	900 × 900 × 65 mm	10 units	07-37-35/600
	Fundo Plano, floor element with fully integrated drain technology, central drain, square	40	1000 × 1000 × 65 mm	10 units	07-37-35/601
	Fundo Plano, floor element with fully integrated drain technology, central drain, square	40	1200 × 1200 × 65 mm	10 units	07-37-35/602
	Fundo Plano, floor element with fully integrated drain technology, central drain, long side connection, rectangular	40	1200 × 900 × 65 mm	10 units	07-37-35/603
	Fundo Plano, floor element with fully integrated drain technology, central drain, short side connection, rectangular	40	1200 × 900 × 65 mm	10 units	07-37-35/604
	Fundo Plano, floor element with fully integrated drain technology, non-central drain, short side connection, rectangular	40	1400 × 900 × 65 mm	10 units	07-37-35/605
	Fundo Plano, floor element with fully integrated drain technology, non-central drain, short side connection, rectangular	40	1600 × 1000 × 65 mm	10 units	07-37-35/606



- !** ▪ One packing unit = 10 pieces; piece acceptance possible!
 - The horizontal drain DN 40 is firmly integrated in the floor element.
 - Drain capacity: 0,5 l / sek.
- 👑** A V₂A brushed stainless steel cover and a large sealing corner (800 × 800 mm) are included in the scope of delivery for all Fundo Plano floor elements.
- i** The technical drawings for these products can be found in Chapter 14, Technology on Page 161.

Fundo Plano Linea ▪ flat complete system with linear drainage

	Description	DN	Length × Width × Height	Channel length	Packing unit/Pallet	Order no.
	Fundo Plano Linea, floor element with channel and fully integrated drain technology, rectangular	40	1200 × 800 × 70 mm	700 mm ①	10 units	07-37-36/600
	Fundo Plano Linea, floor element with channel and fully integrated drain technology, rectangular	40	1200 × 900 × 70 mm	800 mm ②	10 units	07-37-36/601
	Fundo Plano Linea, floor element with channel and fully integrated drain technology, rectangular	40	1200 × 1000 × 70 mm	900 mm ③	10 units	07-37-36/602
	Fundo Plano Linea, floor element with channel and fully integrated drain technology, rectangular	40	1200 × 900 × 70 mm	300 mm	10 units	07-37-36/607
	Fundo Plano Linea, floor element with channel and fully integrated drain technology, square	40	900 × 900 × 70 mm	300 mm	10 units	07-37-36/608
	Fundo Plano Linea, floor element with channel and fully integrated drain technology, square	40	900 × 900 × 70 mm	800 mm ②	10 units	07-37-36/603

-  • One packing unit = 10 pieces; piece acceptance possible!
 - The horizontal drain DN 40 is firmly integrated in the floor element.
 - Drain capacity: 0,4 l / sek.
 - The figures ①, ② and ③ mark the matching combinations with Fundo Discreto.
-  A V₂A height-adjustable brushed stainless steel cover and a large sealing pad (1000 × 450 mm) are included in the scope of delivery for all Fundo Plano Linea floor elements.
-  The technical drawings for these products can be found in Chapter 14, Technology on Page 162.

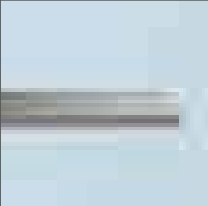

wedi Fundo channel covers exclusive ▪ solid stainless steel, brushed

	Description	Length × Width × Height	Packing unit	Order no.
	wedi Fundo channel cover exclusive, solid stainless steel, brushed	300 × 40 × 21 mm	1 unit	67-68-00/001
	wedi Fundo channel cover exclusive, solid stainless steel, brushed	700 × 40 × 21 mm	1 unit	67-68-00/002
NEW: Only ONE range for ALL drains	wedi Fundo channel cover exclusive, solid stainless steel, brushed	800 × 40 × 21 mm	1 unit	67-68-00/003
	wedi Fundo channel cover exclusive, solid stainless steel, brushed	900 × 40 × 21 mm	1 unit	67-68-00/004
	wedi Fundo channel cover exclusive, solid stainless steel, brushed	1100 × 40 × 21 mm	1 unit	67-68-00/005

- ! For installation heights of 5 to 25 mm.
- These channel drain covers are suitable for all Fundo floor elements with linear drainage.

- 👑 Channel cover, solid stainless steel, brushed
- 1 set of height-adjustable feet
- 2 pieces of 300 mm, pieces of 700 mm and 800 mm
- 6 pieces of 900 mm and 1100 mm

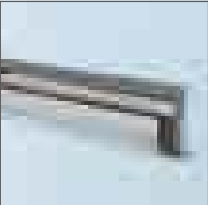
Fundo Discreto ▪ attachment element

	Description	Length × Height × Depth	fits channel length	Packing unit/Pallet	Order no.
	Fundo Discreto, attachment element	800 × 180 × 76 mm	700 mm ①	10 units	07-37-38/200
	Fundo Discreto, attachment element	900 × 180 × 76 mm	800 mm ②	10 units	07-37-38/201
	Fundo Discreto, attachment element	1000 × 180 × 76 mm	900 mm ③	10 units	07-37-38/202

- i • Fundo Discreto has been specially designed for the Fundo Riolito neo, Fundo Riolito and Fundo Plano Linea floor element.
- Numbers ①, ② and ③ are the suitable combination versions with the Fundo Riolito neo, Fundo Riolito and Fundo Plano Linea floor elements.
- The cover can be used and mounted on both sides (visible side V₂A brushed or tiled as desired).
- The technical drawings for these products can be found in Chapter 14, Technology on Page 158.

- 👑 Attachment element
- wedi 610 adhesive sealant
- V₂A cover can be used on both sides



Fundo Riolito neo / Plano Linea slope profile ▪ floor, left, stainless steel V₂A

	Description	Thickness	Length	Packing unit/box	Order no.
	Fundo Riolito neo / Plano Linea slope profile, left-hand version, stainless steel V ₂ A	8.0 mm	1200 mm	1 unit	10-71-00/008
	Fundo Riolito neo / Plano Linea slope profile, left-hand version, stainless steel V ₂ A	10.0 mm	1200 mm	1 unit	10-71-00/010
	NEW Fundo Riolito neo / Plano Linea slope profile, left-hand version, stainless steel V ₂ A	11,0 mm	1200 mm	1 unit	10-71-00/011
	Fundo Riolito neo / Plano Linea slope profile, left-hand version, stainless steel V ₂ A	12.5 mm	1200 mm	1 unit	10-71-00/012
	Fundo Riolito neo / Plano Linea slope profile, left-hand version, stainless steel V ₂ A	8.0 mm	1600 mm	1 unit	10-81-20/008
	Fundo Riolito neo / Plano Linea slope profile, left-hand version, stainless steel V ₂ A	10.0 mm	1600 mm	1 unit	10-81-20/010
	NEW Fundo Riolito neo / Plano Linea slope profile, left-hand version, stainless steel V ₂ A	11,0 mm	1600 mm	1 unit	10-81-20/011
	Fundo Riolito neo / Plano Linea slope profile, left-hand version, stainless steel V ₂ A	12.5 mm	1600 mm	1 unit	10-81-20/012
	Fundo Riolito neo / Plano Linea slope profile, left-hand version, stainless steel V ₂ A	8.0 mm	1800 mm	1 unit	10-81-40/008
	Fundo Riolito neo / Plano Linea slope profile, left-hand version, stainless steel V ₂ A	10.0 mm	1800 mm	1 unit	10-81-40/010
	NEW Fundo Riolito neo / Plano Linea slope profile, left-hand version, stainless steel V ₂ A	11,0 mm	1800 mm	1 unit	10-81-40/011
	Fundo Riolito neo / Plano Linea slope profile, left-hand version, stainless steel V ₂ A	12.5 mm	1800 mm	1 unit	10-81-40/012

- i** ▪ Fits: Fundo Riolito neo / Plano Linea floor elements
 - The slope profile can be individually reduced (length: 1600 mm by max. 400 mm, all other lengths by max. 300 mm).
 - The technical drawings for these products can be found in Chapter 14, Technology on Page 153.



Fundo Riolito neo / Plano Linea slope profile ▪ floor, right, stainless steel V₂A

	Description	Thickness	Length	Packing unit/box	Order no.
	Fundo Riolito neo / Plano Linea slope profile, right-hand version, stainless steel V ₂ A	8.0 mm	1200 mm	1 unit	10-71-10/008
	Fundo Riolito neo / Plano Linea slope profile, right-hand version, stainless steel V ₂ A	10.0 mm	1200 mm	1 unit	10-71-10/010
	NEW Fundo Riolito neo / Plano Linea slope profile, right-hand version, stainless steel V ₂ A	11,0 mm	1200 mm	1 unit	10-71-10/011
	Fundo Riolito neo / Plano Linea slope profile, right-hand version, stainless steel V ₂ A	12.5 mm	1200 mm	1 unit	10-71-10/012
	Fundo Riolito neo / Plano Linea slope profile, right-hand version, stainless steel V ₂ A	8.0 mm	1600 mm	1 unit	10-81-30/008
	Fundo Riolito neo / Plano Linea slope profile, right-hand version, stainless steel V ₂ A	10.0 mm	1600 mm	1 unit	10-81-30/010
	NEW Fundo Riolito neo / Plano Linea slope profile, right-hand version, stainless steel V ₂ A	11,0 mm	1600 mm	1 unit	10-81-30/011
	Fundo Riolito neo / Plano Linea slope profile, right-hand version, stainless steel V ₂ A	12.5 mm	1600 mm	1 unit	10-81-30/012
	Fundo Riolito neo / Plano Linea slope profile, right-hand version, stainless steel V ₂ A	8.0 mm	1800 mm	1 unit	10-81-50/008
	Fundo Riolito neo / Plano Linea slope profile, right-hand version, stainless steel V ₂ A	10.0 mm	1800 mm	1 unit	10-81-50/010
	NEW Fundo Riolito neo / Plano Linea slope profile, right-hand version, stainless steel V ₂ A	11,0 mm	1800 mm	1 unit	10-81-50/011
	Fundo Riolito neo / Plano Linea slope profile, right-hand version, stainless steel V ₂ A	12.5 mm	1800 mm	1 unit	10-81-50/012

- i** ▪ Fits: Fundo Riolito neo / Plano Linea floor elements
- The slope profile can be individually reduced (length: 1600 mm by max. 400 mm, all other lengths by max. 300 mm).
 - The technical drawings for these products can be found in Chapter 14, Technology on Page 153.



Fundo Riolito neo / Plano Linea slope profile ▪ wall, left, stainless steel V₂A

	Description	Thickness	Length	Packing unit/box	Order no.
	Fundo Riolitoneo / Plano Linea slope profile wall, left-hand version, stainless steel V ₂ A	8.0 mm	1200 mm	1 unit	10-72-00/008
	Fundo Riolitoneo / Plano Linea slope profile wall, left-hand version, stainless steel V ₂ A	10.0 mm	1200 mm	1 unit	10-72-00/010
	NEW Fundo Riolitoneo / Plano Linea slope profile wall, left-hand version, stainless steel V ₂ A	11,0 mm	1200 mm	1 unit	10-72-00/011
	Fundo Riolitoneo / Plano Linea slope profile wall, left-hand version, stainless steel V ₂ A	12.5 mm	1200 mm	1 unit	10-72-00/012
	Fundo Riolitoneo / Plano Linea slope profile wall, left-hand version, stainless steel V ₂ A	8.0 mm	1600 mm	1 unit	10-82-20/008
	Fundo Riolitoneo / Plano Linea slope profile wall, left-hand version, stainless steel V ₂ A	10.0 mm	1600 mm	1 unit	10-82-20/010
	NEW Fundo Riolitoneo / Plano Linea slope profile wall, left-hand version, stainless steel V ₂ A	11,0 mm	1600 mm	1 unit	10-82-20/011
	Fundo Riolitoneo / Plano Linea slope profile wall, left-hand version, stainless steel V ₂ A	12.5 mm	1600 mm	1 unit	10-82-20/012
	Fundo Riolitoneo / Plano Linea slope profile wall, left-hand version, stainless steel V ₂ A	8.0 mm	1800 mm	1 unit	10-82-40/008
	Fundo Riolitoneo / Plano Linea slope profile wall, left-hand version, stainless steel V ₂ A	10.0 mm	1800 mm	1 unit	10-82-40/010
	NEW Fundo Riolitoneo / Plano Linea slope profile wall, left-hand version, stainless steel V ₂ A	11,0 mm	1800 mm	1 unit	10-82-40/011
	Fundo Riolitoneo / Plano Linea slope profile wall, left-hand version, stainless steel V ₂ A	12.5 mm	1800 mm	1 unit	10-82-40/012

- i** ▪ Fits: Fundo Riolito neo / Plano Linea floor elements
- The slope profile can be individually reduced (length: 1600 mm by max. 400 mm, all other lengths by max. 300 mm).
- The technical drawings for these products can be found in Chapter 14, Technology on Page 153.

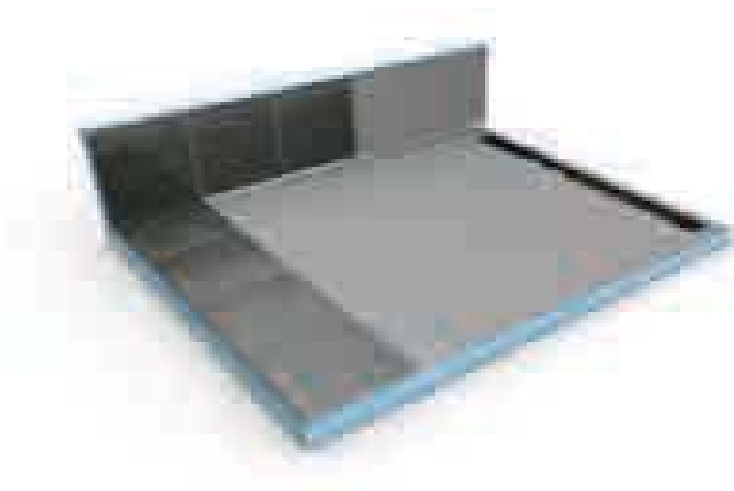

Fundo Riolito neo / Plano Linea slope profile ▪ wall, right, stainless steel V₂A

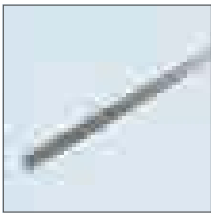
	Description	Thickness	Length	Packing unit/box	Order no.
	Fundo Riolitoneo / Plano Linea slope profile wall, right-hand version, stainless steel V ₂ A	8.0 mm	1200 mm	1 unit	10-72-10/008
	Fundo Riolitoneo / Plano Linea slope profile wall, right-hand version, stainless steel V ₂ A	10.0 mm	1200 mm	1 unit	10-72-10/010
	NEW Fundo Riolitoneo / Plano Linea slope profile wall, right-hand version, stainless steel V ₂ A	11,0 mm	1200 mm	1 unit	10-72-10/011
	Fundo Riolitoneo / Plano Linea slope profile wall, right-hand version, stainless steel V ₂ A	12.5 mm	1200 mm	1 unit	10-72-10/012
	Fundo Riolitoneo / Plano Linea slope profile wall, right-hand version, stainless steel V ₂ A	8.0 mm	1600 mm	1 unit	10-82-30/008
	Fundo Riolitoneo / Plano Linea slope profile wall, right-hand version, stainless steel V ₂ A	10.0 mm	1600 mm	1 unit	10-82-30/010
	NEW Fundo Riolitoneo / Plano Linea slope profile wall, right-hand version, stainless steel V ₂ A	11,0 mm	1600 mm	1 unit	10-82-30/011
	Fundo Riolitoneo / Plano Linea slope profile wall, right-hand version, stainless steel V ₂ A	12.5 mm	1600 mm	1 unit	10-82-30/012
	Fundo Riolitoneo / Plano Linea slope profile wall, right-hand version, stainless steel V ₂ A	8.0 mm	1800 mm	1 unit	10-82-50/008
	Fundo Riolitoneo / Plano Linea slope profile wall, right-hand version, stainless steel V ₂ A	10.0 mm	1800 mm	1 unit	10-82-50/010
	NEW Fundo Riolitoneo / Plano Linea slope profile wall, right-hand version, stainless steel V ₂ A	11,0 mm	1800 mm	1 unit	10-82-50/011
	Fundo Riolitoneo / Plano Linea slope profile wall, right-hand version, stainless steel V ₂ A	12.5 mm	1800 mm	1 unit	10-82-50/012

- i** ▪ Fits: Fundo Riolitoneo / Plano Linea floor elements
- The slope profile can be individually reduced (length: 1600 mm by max. 400 mm, all other lengths by max. 300 mm).
 - The technical drawings for these products can be found in Chapter 14, Technology on Page 153.



Fundo Riolito neo / Plano Linea end profile

	Description	Length × Height	Packing unit/box	Order no.
	Fundo Riolito neo / Plano Linea end profile, stainless steel V ₂ A	1000 × 21 mm	1 unit	10-73-00/001
	Fundo Riolito neo / Plano Linea end profile, stainless steel V ₂ A	1200 × 21 mm	1 unit	10-81-00/001

i The technical drawing for this product can be found in Chapter 14, Technology on Page 154.



NEW Fundo Integro ▪ special floor element

	Description	Dimensions	Order no.
	Fundo Integro, square, rectangular, one piece	Length X: min. 800 mm / max. 1500 mm Width Y: min. 800 mm / max. 1800 mm Thickness: 90 mm	07-37-16/399

! Delivery can take approximately 14 days after receipt of order and confirmation of technical specification. (Only applies to orders of 1 to 3 units; larger numbers of units require an individual check.)

i The technical drawing for this product can be found in Chapter 14, Technology on Page 163.

- Drains can be positioned wherever you like for all individual designs.
- The framework parameters can be found on page 163.

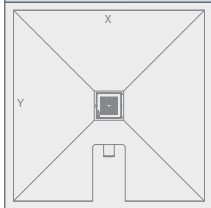

Fundo Plano ▪ special floor element

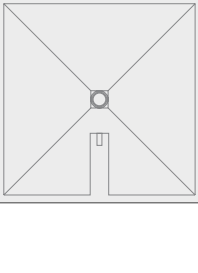
	Description	Dimensions	Restrictions	Order no.
	Fundo Plano, square, rectangular, one piece	Length X: min. 800 mm / max. 1500 mm Width Y: min. 800 mm / max. 1600 mm Thickness: 65 mm	Slope section YA: min. 260 mm / max. 900 mm Slope section YB: min. 260 mm / max. 900 mm Slope section XA: min. 260 mm / max. 900 mm Slope section XB: min. 450 mm / max. 600 mm	07-37-14/699

- ! ▪ Delivery can take approximately 14 days after receipt of order and confirmation of technical specification. (Only applies to orders of 1 to 3 units; larger numbers of units require an individual check.)
- i ▪ The technical drawing for this product can be found in Chapter 14, Technology on Page 163.
- Drains can be positioned wherever you like for all individual designs with taking the edge parameters into consideration!

Fundo Plano Linea ▪ special floor element

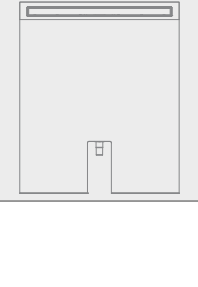
	Description	Dimensions	Restrictions	Order no.
	Fundo Plano Linea, square, rectangular, one piece	1-sided slope: Length X: max. 1400 mm Width Y: max. 1500 mm Thickness: 70 mm 2-sided slope: Length X: max. 1600 mm Width Y: max. 1500 mm Thickness: 70 mm 4-sided slope: Length X: max. 1600 mm Width Y: max. 1500 mm Thickness: 70 mm	Dimensions YA: min. 30 mm / max. 300 mm	07-37-15/799

- ! ▪ Delivery can take approximately 14 days after receipt of order and confirmation of technical specification. (Only applies to orders of 1 to 3 units; larger numbers of units require an individual check.)
- i ▪ The technical drawing for this product can be found in Chapter 14, Technology on Page 164.
- Fundo Plano Linea drains can be positioned wherever you like for all individual designs with taking the edge parameters into consideration!

10

Installation materials & sealing

Quick, high-quality and guaranteed to be reliable. The versatile portfolio of wedi sealing systems offers high-performance sealing solutions for the entire shower. From the tried-and-tested wedi 610 adhesive and sealant and fleece-lined sealing membranes and corners to the extensive Fundo sealing set for all connections and joints in the shower and for adjacent wall and floor areas.

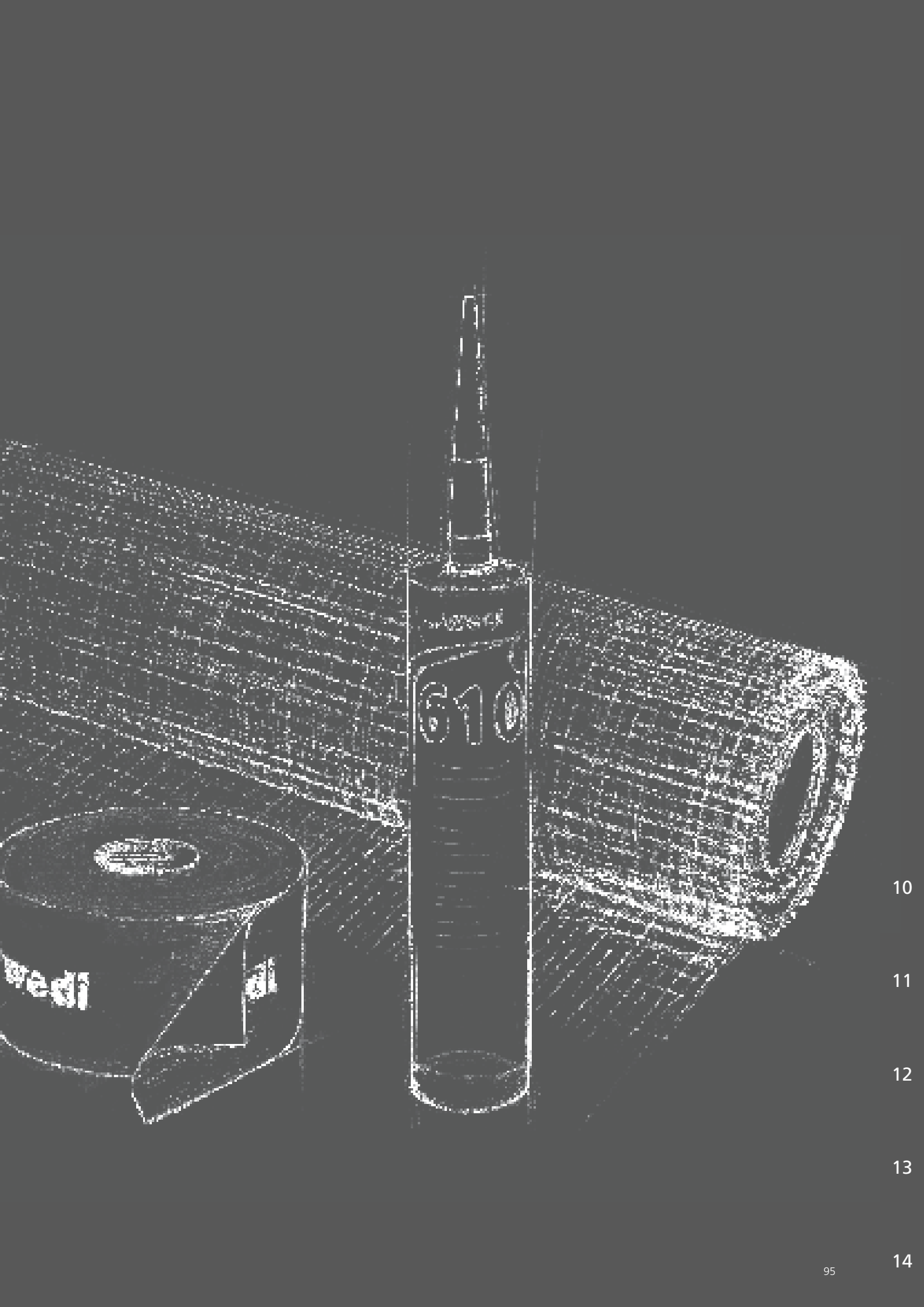

10

11

12

13

14

wedi 610 ▪ adhesive sealant

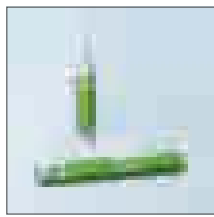

Description	Content	Packing unit	Packing unit/box	Order no.
wedi 610, adhesive sealant	310 ml	1 Cartridge	20 units	07-69-02/002
NEW wedi 610, adhesive sealant	600 ml	1 Tubular bag	20 units	07-69-02/007

- i** ▪ Consumption: 8 – 10 m per cartridge
- Adhesive and sealant for waterproof adhesion of wedi building boards and Fundo elements

wedi 520 ▪ Flexible sealants

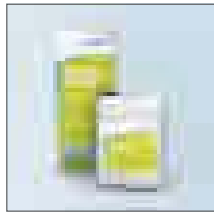

Description	Content	Packing unit	Packing unit/Pallet	Order no.
wedi 520, Flexible sealants, component A + B	20 kg + 10 kg	1 sack + 1 can	40 units	11-99-00/520

- i** ▪ Consumption per m² (for surface sealing):
wedi 520 component A (powder) at 2 mm dry layer thickness (approx. 2.4 mm wet layer thickness): approx. 2,8 kg/m²
wedi 520 component B (fluid) at 2 mm dry layer thickness (approx. 2.4 mm wet layer thickness): approx. 1,4 kg/m²
- Consumption per serial metre (for joint sealing):
wedi 520 component A (powder) at 2 mm dry layer thickness (approx. 2.4 mm wet layer thickness): approx. 0,28 kg/serial metre
wedi 520 component B (fluid) at 2 mm dry layer thickness (approx. 2.4 mm wet layer thickness): approx. 0,14 kg/serial metre

wedi edge insulation strips



Description	Roll length × Width × Thickness	Packing unit	Order no.
wedi edge insulation strips	25 m × 150 mm × 5 mm	1 roll	01-12-55/006

wedi Tools ▪ joint reinforcement tape



Description	Roll length × Width	Packing unit/box	Order no.
wedi Tools, joint reinforcement tape	25 m × 125 mm	1 roll	09-52-20/053
wedi Tools, joint reinforcement tape	50 m × 600 mm	1 roll	09-52-10/052

- i** Band to reinforce and stabilise structural panel joints

wedi Tools ▪ joint reinforcement tape, self-adhesive



Description	Roll length × Width	Packing unit/box	Order no.
wedi Tools, joint reinforcement tape, self-adhesive	25 m × 125 mm	1 roll	09-52-25/053
wedi Tools, joint reinforcement tape, self-adhesive	50 m × 600 mm	1 roll	09-52-15/052

- i** Self-adhesive band to reinforce and stabilise structural panel joints

wedi Fundo sealing set

	Description	Packing unit	Order no.
	wedi Fundo sealing set	1 bucket	07-37-96/000
	! A Fundo sealing set is sufficient for installing a Fundo floor element including the respective wall elements.		

wedi Tools ▪ sealing tape, fleece laminated

	Description	Roll length × Width	Packing unit/box	Order no.
	wedi Tools, sealing tape, fleece laminated	50 m × 100 mm	1 roll	09-51-00/352
	wedi Tools, sealing tape, fleece laminated	10 m × 120 mm	1 roll	09-51-10/311
	wedi Tools, sealing tape, fleece laminated	50 m × 120 mm	1 roll	09-51-10/352

wedi Tools ▪ inside corners, fleece laminated

	Description	Length of side piece	Packing unit/box	Order no.
	wedi Tools, inside corners, fleece laminated	120 × 120 mm	25 units	09-51-30/001

wedi Tools ▪ outside corners, fleece laminated

	Description	Length of side piece	Packing unit/box	Order no.
	wedi Tools, outside corners, fleece laminated	115 × 115 mm	25 units	09-51-35/001

wedi Tools ▪ sealing gaiter

	Description	Dimensions	Packing unit/Sachet	Order no.
	wedi Tools, sealing gaiter, fleece laminated, extendable, suitable for 1/2" to 3/4" feed-throughs	120 × 120 mm	10 units	09-51-20/050
	wedi Tools, sealing gaiter, fleece laminated, extendable DN 40 – 75	150 × 150 mm	5 units	09-51-10/361
	wedi Tools, sealing gaiter, fleece laminated, extendable DN 90 – 125, also for fittings	250 × 250 mm Ø 135 mm	5 units	09-51-10/362

wedi Tools ▪ butyl bathtub sealing tape

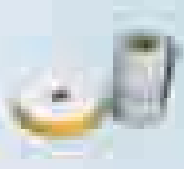
	Description	Roll length × Width	Packing unit/box	Order no.
	wedi butyl bathtub sealing tape	3600 × 120 mm	1 roll	09-51-10/360
	wedi butyl bathtub sealing tape + self-adhesive decoupling strip	3600 × 120 mm 3600 × 30 mm	1 Set	09-51-10/363

wedi Subliner Dry ▪ sealing membrane

	Description	Roll length × Width	Packing unit/Pallet	Order no.
	wedi Subliner Dry, sealing membrane	30 m × 1 m	40 rolls	09-51-10/332
wedi Subliner Dry, sealing membrane	5 m × 1 m	96 rolls	09-51-10/305	

! Flexible sealing membrane for medium and high wet areas inside.

wedi Subliner Dry & Flex ▪ sealing and decoupling membrane

	Description	Roll length × Width	Packing unit/Pallet	Order no.
	wedi Subliner Dry & Flex, sealing and decoupling membrane	15 m × 1 m	36 rolls	09-51-10/315

! Sealing and decoupling membrane for medium and high wet areas inside and outside with crack bypassing properties.

wedi protective covering fabric

	Description	Roll length × Width	Packing unit/Pallet	Order no.
	wedi protective covering fabric	25 m × 1 m	12 rolls	08-46-00/100

wedi Tools ▪ connector 90°

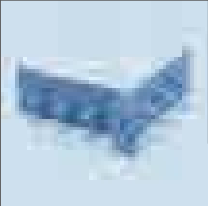
	Description	Packing unit/Blister	Packing unit/box	Order no.
	wedi Tools, connector 90°		100 units	09-53-00/191
	wedi Tools, connector 90°	5 units		09-53-03/191

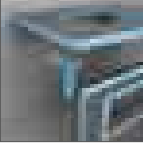



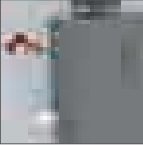

wedi Tools ▪ wall connector

	Description	Packing unit/Blister	Packing unit/box	Order no.
	wedi Tools, wall connector		100 units	09-53-00/192
	wedi Tools, wall connector	5 units		09-53-03/192

wedi Tools ▪ connector 180°

	Description	Packing unit/Blister	Packing unit/box	Order no.
	wedi Tools, connector 180°		100 units	09-53-00/193
	wedi Tools, connector 180°	5 units		09-53-03/193

10



11

12



13

14

wedi Tools ▪ fixings set

	Description	Length × Width × Thickness	Number / set	Order no.
	wedi Tools, fixings set, composite material	400 × 50 × 15 mm 100 × 100 × 8 mm	2 units 12 units	20-65-53/001
<p>i • This is a set consisting of 12 small panels (100 × 100 × 8 mm) and 2 elongated panels (400 × 50 × 15 mm).</p> <p>• To reinforce wedi structural panels for the purpose of fixing loads.</p> <p>! • For secure hold of heavy objects, such as fittings or solid shelves, under the tiles.</p> <p>• For bond tensile strength values of up to 160 kg.</p>				

wedi Tools ▪ cavity dowels set

	Description	Diameter × Length	Packing unit	Order no.
	wedi Tools, cavity dowels set, 10 dowels and 10 screws	screw: Ø 4,5 × 60 mm dowel: Ø 6,0 × 35 mm	1 Sachet	20-65-53/004
<p>i The dowels are particularly suited to fastening hooks, towel rails, small pieces of mounted furniture to tiled wedi structural panels.</p> <p>! • To fix bathroom accessories, such as mirrors, towel rails, etc. after tiling.</p> <p>• For loads of up to 25 kg.</p>				



10

11

12

13

14

11

Sound insulation & decoupling

Invisible but still essential: The wedi installation systems for wet rooms. Be it ready-to-lay parquet, laminate or fleece – once installed before the flooring, they provide a series of advantages. The special wedi Nonstep impact sound-deadening boards considerably reduce the propagation of water impact and footfall, ensuring peace and a higher quality of life. With the Subliner decoupling membranes, you can protect ceramic floorings, such as high-quality tiles, from any tensions from the ground. For durable and long-lasting beautiful flooring in your bathroom.

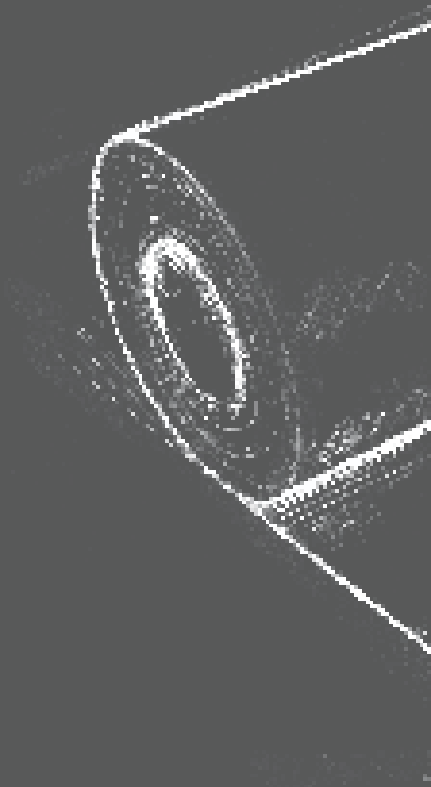

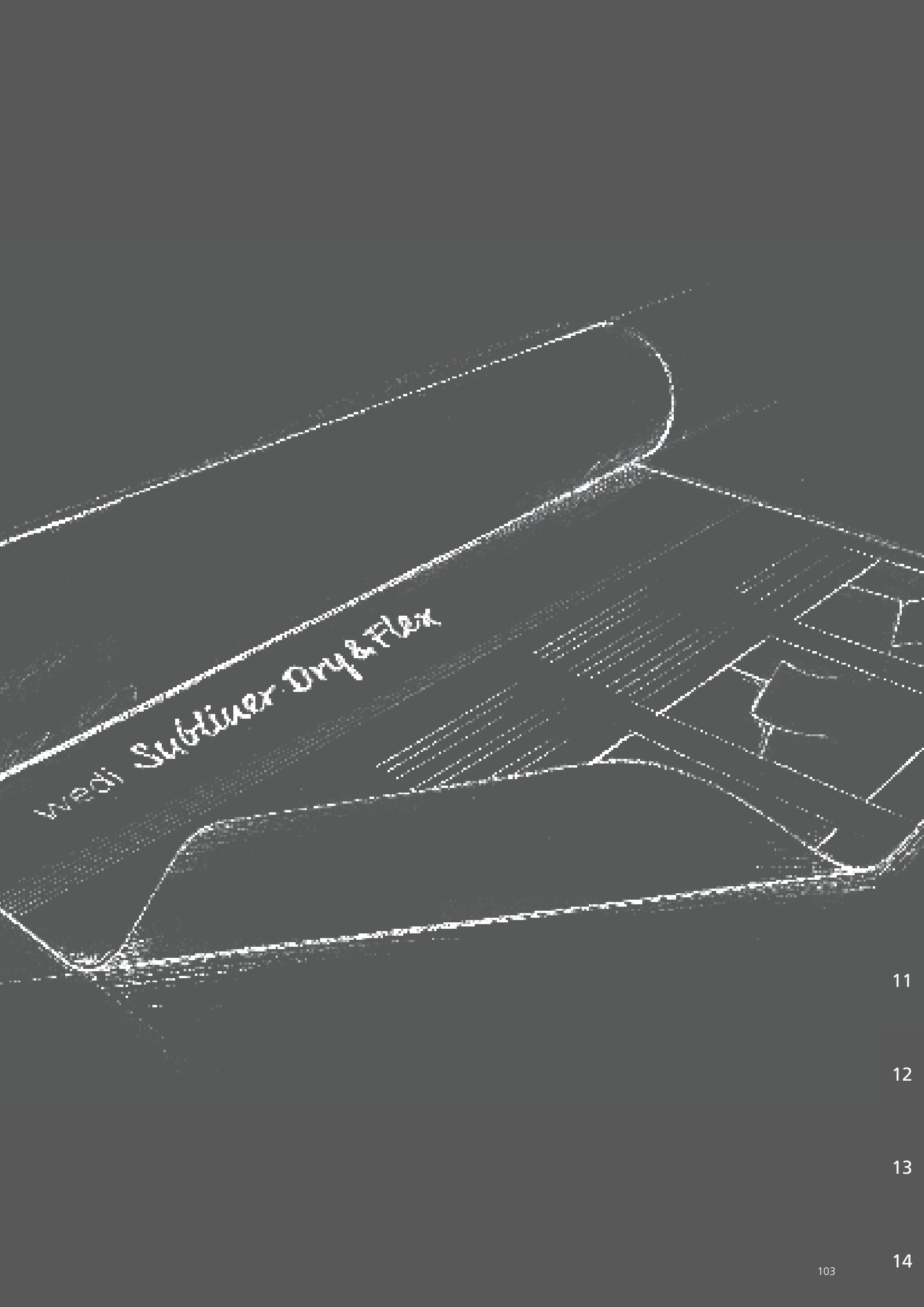

Wedj Subliner Dry & Flex

11

12

13

14

wedi Nonstep Plan ▪ sound insulation mat



Description	Length × Width × Height	Packing unit/Pallet	Order no.
wedi Nonstep Plan	1196 × 590 × 6 mm	50 boards = 35,28 m ²	01-12-20/000

i Suitable for direct tiling, improvement in impact sound deadening: 14 dB.

wedi Nonstep Plus ▪ sound insulation composite panel



Description	Length × Width × Height	Packing unit/Pallet	Order no.
wedi Nonstep Plus	1200 × 600 × 12 mm	50 boards = 36 m ²	01-12-00/000

i Suitable for direct tiling, improvement in impact sound deadening: 16 dB.

wedi Nonstep Pro ▪ sound insulation mat



Description	Length × Width × Thickness	Packing unit	Order no.
wedi Nonstep Pro	600 × 600 × 8 mm	4 units	01-12-55/000
wedi Nonstep Pro	900 × 5000 × 8 mm	1 roll	01-12-55/001
wedi Nonstep Pro	1200 × 5000 × 8 mm	1 roll	01-12-55/002
wedi Nonstep Pro	600 × 600 × 17 mm	4 units	01-12-55/003
wedi Nonstep Pro	900 × 2500 × 17 mm	1 roll	01-12-55/004
wedi Nonstep Pro	1200 × 2500 × 17 mm	1 roll	01-12-55/005

i For sound insulation under wedi Fundo systems to achieve the increased sound protection as per VDI 4100.

wedi edge insulation strips



Description	Roll length × Width × Thickness	Packing unit	Order no.
wedi edge insulation strips	25 m × 150 mm × 5 mm	1 roll	01-12-55/006

wedi Subliner Flex ▪ decoupling membrane

	Description	Roll length × Width	Packing unit/Pallet	Order no.
	wedi Subliner Flex, decoupling membrane	30 m × 1 m	18 rolls	09-51-10/331
<p>! Tension-reducing membrane for inside.</p>				

wedi Subliner Dry & Flex ▪ sealing and decoupling membrane

	Description	Roll length × Width	Packing unit/Pallet	Order no.
	wedi Subliner Dry & Flex, sealing and decoupling membrane	15 m × 1 m	36 rolls	09-51-10/315
<p>! Sealing and decoupling membrane for medium and high wet areas inside and outside with crack by passing properties.</p>				

12

Finished elements

The extensive variety of forms of wedi Wellness finished elements leave nothing to be desired. Be it straight benches, corner constructions, clean connecting solutions or loungers – the different designs enable the creation of stylish and modern bathroom and wellness areas, which will emphasise the features and invite you to relax by the time the tiling is complete.



Don't forget: Matching accessories

- wedi 610 ▪ adhesive and sealant for waterproof adhesion of joints
- wedi Tools joint reinforcement tape ▪ to reinforce joints
- wedi Tools sealing tape ▪ for watertight connection to non-system materials
- wedi Fundo sealing set ▪ especially to seal wedi products to non-system materials

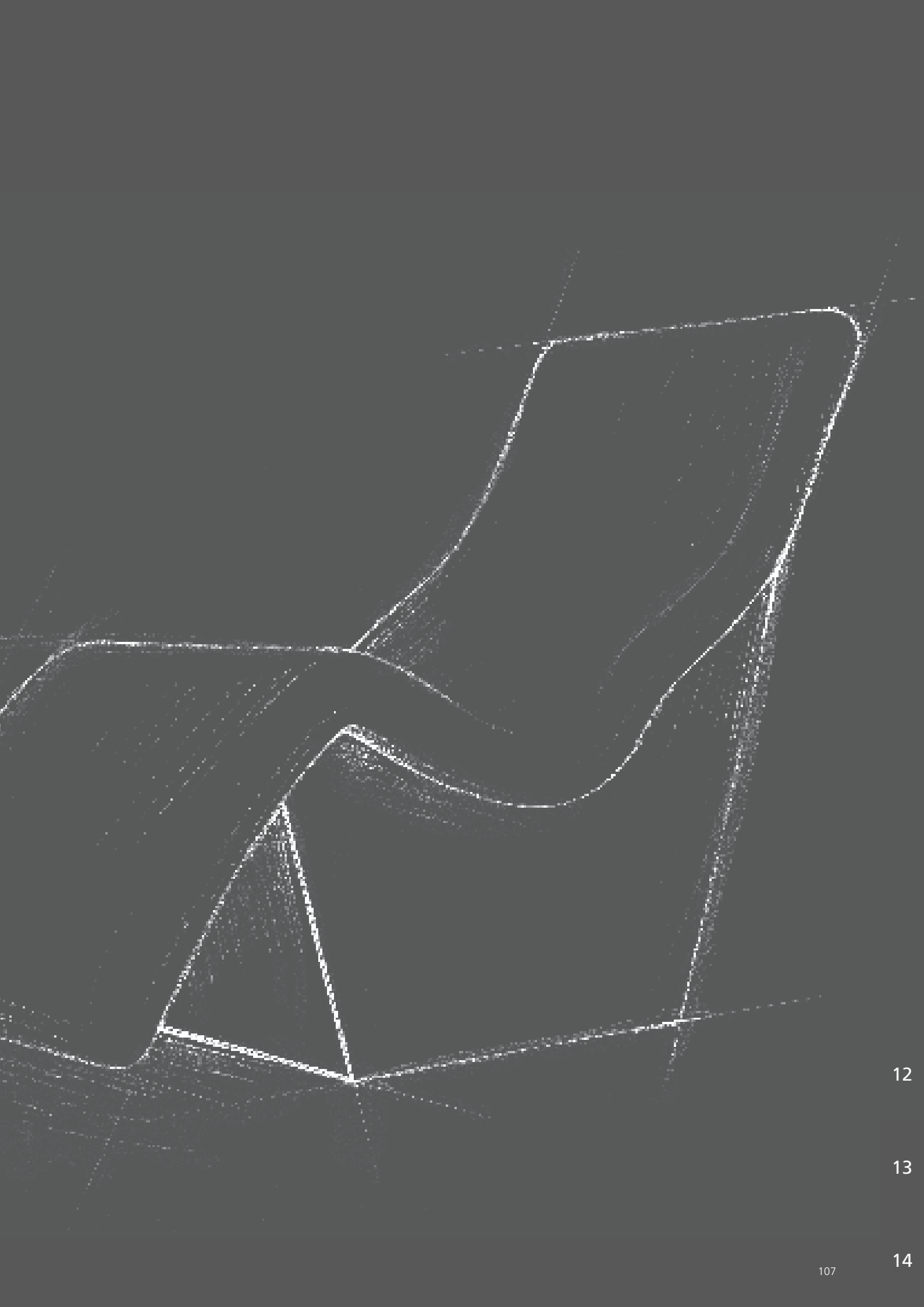





12





13

14





wedi Sanoasa bench 1

	Description	Length	Seat depth	Height	Order no.
	wedi Sanoasa bench 1, straight	900 mm	380 mm	454 mm	07-64-47/020
	wedi Sanoasa bench 1, straight	1200 mm	380 mm	454 mm	07-64-47/021
	<ul style="list-style-type: none"> The bench is delivered in four parts: Bench element, substructure element and 2 x BA 6 (as the cover plate or compensating panels) The separating height for the installation of the Fundo Discreto is 180 mm on the straight side of the substructure element. wedi 610 is required for adhesion. The (wall) connection is carried out using reinforcing tape. 		Sanoasa bench 1 ▪ Seat surface: ▪ Front surface: ▪ Side surface:	900 mm: approx. 0,34 m ² approx. 0,41 m ² approx. 0,17 m ²	1200 mm: approx. 0,46 m ² approx. 0,54 m ² approx. 0,17 m ²
	The technical drawings for these products can be found in Chapter 14, Technology on Page 164.				

wedi Sanoasa bench 2

	Description	Length	Seat depth	Height	Order no.
	wedi Sanoasa bench 2, angled	900 mm	380 mm	454 mm	07-64-47/022
	wedi Sanoasa bench 2, angled	1200 mm	380 mm	454 mm	07-64-47/023
	<ul style="list-style-type: none"> The bench is delivered in four parts: Bench element, substructure element and 2 x BA 6 (as the cover plate or compensating panels) The separating height for the installation of the Fundo Discreto is 180 mm on the straight side of the substructure element. wedi 610 is required for adhesion. The (wall) connection is carried out using reinforcing tape. 		Sanoasa bench 2 ▪ Seat surface: ▪ Front surface: ▪ Side surface:	900 mm: approx. 0,34 m ² approx. 0,43 m ² approx. 0,17 m ²	1200 mm: approx. 0,46 m ² approx. 0,57 m ² approx. 0,17 m ²
	The technical drawings for these products can be found in Chapter 14, Technology on Page 164.				

wedi Sanoasa bench 3

	Description	Length	Seat depth	Height	Order no.
	wedi Sanoasa bench 3, rounded	900 mm	380 mm	454 mm	07-64-47/024
	wedi Sanoasa bench 3, rounded	1200 mm	380 mm	454 mm	07-64-47/025
	<ul style="list-style-type: none"> The bench is delivered in four parts: Bench element, substructure element and 2 x BA 6 (as the cover plate or compensating panels) The separating height for the installation of the Fundo Discreto is 180 mm on the straight side of the substructure element. wedi 610 is required for adhesion. The (wall) connection is carried out using reinforcing tape. 		Sanoasa bench 3 ▪ Seat surface: ▪ Front surface: ▪ Side surface:	900 mm: approx. 0,38 m ² approx. 0,36 m ² approx. 0,17 m ²	1200 mm: approx. 0,51 m ² approx. 0,49 m ² approx. 0,17 m ²
	The technical drawings for these products can be found in Chapter 14, Technology on Page 164.				

wedi Sanoasa bench 4

	Description	Width x Depth x Thickness	Order no.
	wedi Sanoasa bench 4, straight, self-supporting	1200 x 380 x 80 mm	07-64-47/041
<p>! For installation wedi 610 and joint reinforcement is needed.</p> <p>i The technical drawings for these products can be found in Chapter 14, Technology on Page 165.</p>		<p>m² ■ Top: approx. 0,46 m²</p> <p>■ Bottom: approx. 0,46 m²</p> <p>■ Front: approx. 0,10 m²</p>	

wedi Sanoasa corner seat element

	Description	Width x Depth x Thickness	Order no.												
	wedi Sanoasa corner seat element, size M	600 x 300 x 100 mm	07-37-84/302												
wedi Sanoasa corner seat element, size L	800 x 400 x 100 mm	07-37-84/402													
<p>! For installation wedi 610 is needed.</p> <p>i The technical drawings for these products can be found in Chapter 14, Technology on Page 165.</p> <p>👑 ■ 1 seat element</p> <p>■ 2 installation beams</p> <p>■ 3 m joint reinforcement tape</p>		<p>m² Sanoasa corner seat element</p> <table border="0"> <tr> <td></td> <td>size M</td> <td>size L</td> </tr> <tr> <td>■ Front:</td> <td>approx. 0,09 m²</td> <td>approx. 0,16 m²</td> </tr> <tr> <td>■ Rear panel:</td> <td>approx. 0,09 m²</td> <td>approx. 0,16 m²</td> </tr> <tr> <td>■ Sides:</td> <td>approx. 0,06 m²</td> <td>approx. 0,08 m²</td> </tr> </table>		size M	size L	■ Front:	approx. 0,09 m ²	approx. 0,16 m ²	■ Rear panel:	approx. 0,09 m ²	approx. 0,16 m ²	■ Sides:	approx. 0,06 m ²	approx. 0,08 m ²	
	size M	size L													
■ Front:	approx. 0,09 m ²	approx. 0,16 m ²													
■ Rear panel:	approx. 0,09 m ²	approx. 0,16 m ²													
■ Sides:	approx. 0,06 m ²	approx. 0,08 m ²													

NEW wedi Sanwell wall element ■ Partition wall with niche

	Description	Length x Width x Depth	Packing unit	Order no.
	wedi Sanwell wall element XL, with niche 30/60	2500 x 900 x 100 mm	1 unit	04-17-01/100
wedi Sanwell wall element XXL, with niche 30/60	2500 x 1200 x 100 mm	1 unit	04-17-01/101	



i The technical drawings for these products can be found in Chapter 14, Technology on Page 165.

wedi Sanwell Niche

	Description	Interior dimensions: Length x Width x Depth	Exterior dimensions: Length x Width x Depth	Packing unit/ Pallet	Order no.
	wedi Sanwell Niche, 20/40, Frame width 10,0 mm	234 x 434 x 100 mm	454 x 654 x 110 mm	24 units	07-43-15/410
wedi Sanwell Niche, 30/60, Frame width 10,0 mm	334 x 634 x 100 mm	554 x 854 x 110 mm	20 units	07-43-15/411	
wedi Sanwell Niche, 20/40, Frame width 12,5 mm	234 x 434 x 70 mm	372 x 572 x 82,5 mm	60 units	07-43-15/420	
wedi Sanwell Niche, 30/60, Frame width 12,5 mm	334 x 634 x 70 mm	472 x 772 x 82,5 mm	30 units	07-43-15/421	

i The technical drawings for these products can be found in Chapter 14, Technology on Page 166.

wedi Sanoasa Comoda ▪ bench / carrier element

	Description	Length	Order no.
 bench element, slope to front	wedi Sanoasa Comoda, bench element, slope to front	1000 mm	07-64-47/015
	wedi Sanoasa Comoda, bench element, slope to front	2000 mm	07-64-38/000
 carrier element with round finish length	wedi Sanoasa Comoda, carrier element, round finish length	1000 mm	07-64-37/500
	wedi Sanoasa Comoda, carrier element, straight finish length	1000 mm	07-64-37/000

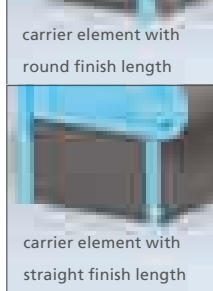

- !** • The bench element is supplied in two parts, a back rest and a seat.
- One wedi 610 cartridge is needed for adhesion per 1000 mm bench.
- Each bench element (2000 mm) requires two carrier elements.
- For hot water or electrical heating sets which are to be installed on site, the delivery time is approx. 5 weeks ex-works.

i The technical drawings for these products can be found in Chapter 14, Technology on Page 166.



- +** • Bench element with integrated electrical heating set: 1000 mm
- Bench element with integrated hot water heating set: 1000 mm

- m²** Bench element (for 2000 mm length):
 - Front: approx. 2,30 m²
 - Rear panel: approx. 1,24 m²
 - Sides: approx. 0,31 m²

Carrier elements (for 2000 mm length):

- Front: approx. 0,60 m²
- Rear panel: approx. 0,50 m²
- Sides: approx. 0,25 m²

wedi Sanoasa Comoda ▪ corner element 90°

	Description	Length × Width × Height	Order no.
 corner element with straight transition	wedi Sanoasa Comoda, bench corner element 90°, straight, slope to front	650 × 650 × 620 mm	07-64-47/004
	wedi Sanoasa Comoda, carrier corner element 90°, straight	650 × 650 × 620 mm	07-64-47/005
 corner element with round transition	wedi Sanoasa Comoda, bench corner element 90°, round, slope to front	850 × 850 × 620 mm	07-64-47/000
	wedi Sanoasa Comoda, carrier corner element 90°, round	850 × 850 × 250 mm	07-64-47/001

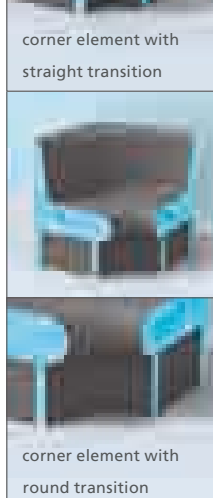

- !** • The bench element shall be glued to the carrier element using wedi 610, adhesive sealant.
- Delivery time is approx. 3 weeks ex-works.
- The corner elements can only be supplied with the downwards-running substructure.

i The technical drawings for these products can be found in Chapter 14, Technology on Page 167.

- m²** Bench corner element straight: round:
 - Front: approx. 0,90 m² approx. 1,20 m²
 - Rear panel: approx. 0,90 m² approx. 1,10 m²
 - Sides: approx. 0,31 m² approx. 0,31 m²

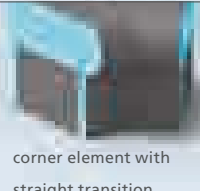

- Carrier corner element straight: round:
 - Front: approx. 0,10 m² approx. 0,20 m²
 - Rear panel: approx. 0,40 m² approx. 0,50 m²
 - Sides: approx. 0,25 m² approx. 0,25 m²

wedi Sanoasa Comoda ■ corner element 135°

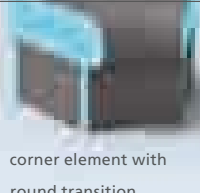
	Description	Length × Width × Height	Order no.
	wedi Sanoasa Comoda, bench corner element 135°, straight, slope to front	600 × 660 × 620 mm	07-64-47/006
	wedi Sanoasa Comoda, carrier corner element 135°	660 × 500 × 250 mm	07-64-47/007
	wedi Sanoasa Comoda, bench corner element 135°, round, slope to front	600 × 660 × 620 mm	07-64-47/002
	wedi Sanoasa Comoda, carrier corner element 135°	660 × 500 × 250 mm	07-64-47/003



	<p>! • The bench element shall be glued to the carrier element using wedi 610, adhesive sealant.</p> <p>• Delivery time is approx. 3 weeks ex-works.</p> <p>• The corner elements can only be supplied with the downwards-running substructure.</p> <p>i The technical drawings for these products can be found in Chapter 14, Technology on Page 168.</p>	m² Bench corner element	straight:	round:
			▪ Front: approx. 0,80 m ²	approx. 0,80 m ²
		▪ Rear panel: approx. 0,50 m ²	approx. 0,50 m ²	
		▪ Sides: approx. 0,31 m ²	approx. 0,31 m ²	
		Carrier corner element	straight:	round:
		▪ Front: approx. 0,10 m ²	approx. 0,10 m ²	
		▪ Rear panel: approx. 0,20 m ²	approx. 0,20 m ²	
		▪ Sides: approx. 0,25 m ²	approx. 0,25 m ²	

wedi Sanoasa Comoda ■ end element left

	Description	Length × Width × Height	Order no.
	wedi Sanoasa Comoda, bench end element left, R = 200, slope to front	600 × 300 × 620 mm	07-64-47/011
R = 200	wedi Sanoasa Comoda, carrier end element, R = 200	500 × 200 × 250 mm	07-64-47/013
	wedi Sanoasa Comoda, bench end element left, R = 600, slope to front	700 × 600 × 620 mm	07-64-47/008
R = 600	wedi Sanoasa Comoda, carrier end element, R = 600	600 × 500 × 250 mm	07-64-47/010

	<p>! • The bench element shall be glued to the carrier element using wedi 610, adhesive sealant.</p> <p>• Delivery time is approx. 3 weeks ex-works.</p> <p>i The technical drawings for these products can be found in Chapter 14, Technology on Page 168.</p>	m² Bench end element	R = 200:	R = 600:
			▪ Front: approx. 0,60 m ²	approx. 0,80 m ²
		▪ Rear panel: approx. 0,20 m ²	approx. 0,30 m ²	
		▪ Sides: approx. 0,31 m ²	approx. 0,31 m ²	
		Carrier end element	R = 200:	R = 600:
		▪ Front: approx. 0,20 m ²	approx. 0,30 m ²	
		▪ Rear panel: approx. 0,10 m ²	approx. 0,20 m ²	
		▪ Sides: approx. 0,25 m ²	approx. 0,25 m ²	

wedi Sanoasa Comoda ▪ end element right

	Description	Length × Width × Height	Order no.
 R = 200	wedi Sanoasa Comoda, bench end element right, R = 200, slope to front	600 × 300 × 620 mm	07-64-47/012
	wedi Sanoasa Comoda, carrier end element, R = 200	500 × 200 × 250 mm	07-64-47/013
 R = 600	wedi Sanoasa Comoda, bench end element right, R = 600, slope to front	700 × 600 × 620 mm	07-64-47/009
	wedi Sanoasa Comoda, carrier end element, R = 600	600 × 500 × 250 mm	07-64-47/010

- !** • The bench element shall be glued to the carrier element using wedi 610, adhesive sealant.
 • Delivery time is approx. 3 weeks ex-works.
- i** The technical drawings for these products can be found in Chapter 14, Technology on Page 169.

m² Bench end element	R = 200:	R = 600:	
	▪ Front:	approx. 0,60 m ²	approx. 0,80 m ²
	▪ Rear panel:	approx. 0,20 m ²	approx. 0,30 m ²
	▪ Sides:	approx. 0,31 m ²	approx. 0,31 m ²
Carrier end element	R = 200:	R = 600:	
	▪ Front:	approx. 0,20 m ²	approx. 0,30 m ²
	▪ Rear panel:	approx. 0,10 m ²	approx. 0,20 m ²
	▪ Sides:	approx. 0,25 m ²	approx. 0,25 m ²

wedi Sanoasa Comoda ▪ armrest

	Description	Length × Width × Height	Order no.
	wedi Sanoasa Comoda, armrest	650 × 105 × 870 mm	07-64-47/014

- !** • The Sanoasa Comoda armrest can be installed equally on the right or the left.
 • The armrest must be glued to the bench element and carrier element using wedi 610 adhesive sealant.
 • Delivery time is approx. 3 weeks ex-works.
- i** The technical drawing for this product can be found in Chapter 14, Technology on Page 169.

m² Armrest:	▪ Front:	approx. 0,75 m ²
	▪ Rear panel:	approx. 0,10 m ²
	▪ Sides:	approx. 0,90 m ²

wedi Sanoasa Bellina ■ bench / carrier element

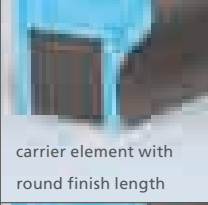
	Description	Length	Order no.
	wedi Sanoasa Bellina, bench element, slope to front	1000 mm	07-64-48/015
	wedi Sanoasa Bellina, bench element, slope to front	2000 mm	07-64-41/000
	wedi Sanoasa Bellina, carrier element, round finish length	1000 mm	07-64-41/600
	wedi Sanoasa Bellina, carrier element, straight finish length	1000 mm	07-64-41/500

carrier element with round finish length

carrier element with straight finish length

- ! The bench element is supplied in two parts, a back rest and a seat.
- One wedi 610 cartridge is needed for adhesion per 1000 mm bench.
- The article is immediately available.
- For hot water or electrical heating sets which are to be installed on site, the delivery time is approx. 5 weeks ex-works.

i The technical drawings for these products can be found in Chapter 14, Technology on Page 169.

- ⊕ Bench element with integrated electrical heating set: 1000 mm
- Bench element with integrated hot water heating set: 1000 mm

- m² Bench element (for 2000 mm length):
- Front: approx. 1,45 m²
- Rear panel: approx. 0,50 m²
- Sides: approx. 0,19 m²

- Carrier elements (for 2000 mm length):
- Front: approx. 0,60 m²
- Rear panel: approx. 0,50 m²
- Sides: approx. 0,19 m²

wedi Sanoasa Bellina ■ corner element 90°

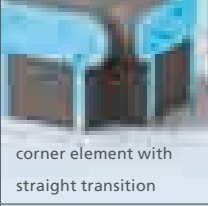
	Description	Length × Width × Height	Order no.
	wedi Sanoasa Bellina, bench corner element 90°, straight, slope to front	550 × 550 × 240 mm	07-64-48/004
	wedi Sanoasa Bellina, carrier corner element 90°	550 × 550 × 250 mm	07-64-48/005
	wedi Sanoasa Bellina, bench corner element 90°, round, slope to front	736 × 736 × 240 mm	07-64-48/000
	wedi Sanoasa Bellina, carrier corner element 90°	736 × 736 × 250 mm	07-64-48/001

corner element with straight transition

corner element with round transition

corner element with round transition

- ! The bench element shall be glued to the carrier element using wedi 610, adhesive sealant.
- Delivery time is approx. 3 weeks ex-works.
- The corner elements can only be supplied with the downwards-running substructure.

i The technical drawings for these products can be found in Chapter 14, Technology on Page 170.

- m² Bench corner element straight: round:
- Front: approx. 0,35 m² approx. 0,45 m²
- Rear panel: approx. 0,30 m² approx. 0,30 m²
- Sides: approx. 0,19 m² approx. 0,19 m²

- Carrier corner element straight: round:
- Front: approx. 0,10 m² approx. 0,15 m²
- Rear panel: approx. 0,30 m² approx. 0,30 m²
- Sides: approx. 0,20 m² approx. 0,20 m²

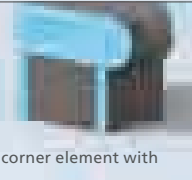
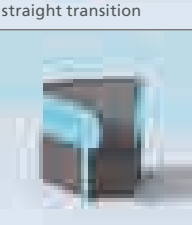
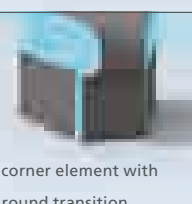

wedi Sanoasa Bellina ▪ corner element 135°

	Description	Length × Width × Height	Order no.
	wedi Sanoasa Bellina, bench corner element 135°, straight, slope to front	486 × 486 × 240 mm	07-64-48/006
	wedi Sanoasa Bellina, carrier corner element 135°	512 × 485 × 250 mm	07-64-48/007
	wedi Sanoasa Bellina, bench corner element 135°, round, slope to front	638 × 608 × 240 mm	07-64-48/002
	wedi Sanoasa Bellina, carrier corner element 135°	638 × 486 × 250 mm	07-64-48/003
 corner element with straight transition	<p>! • The bench element shall be glued to the carrier element using wedi 610, adhesive sealant.</p> <p>• Delivery time is approx. 3 weeks ex-works.</p> <p>• The corner elements can only be supplied with the downwards-running substructure.</p> <p>i The technical drawings for these products can be found in Chapter 14, Technology on Page 170.</p>	<p>m² Bench corner element straight:</p> <p>▪ Front: approx. 0,25 m²</p> <p>▪ Rear panel: approx. 0,15 m²</p> <p>▪ Sides: approx. 0,19 m²</p> <p>Carrier corner element straight:</p> <p>▪ Front: approx. 0,10 m²</p> <p>▪ Rear panel: approx. 0,15 m²</p> <p>▪ Sides: approx. 0,20 m²</p>	<p>round:</p> <p>approx. 0,35 m²</p> <p>approx. 0,20 m²</p> <p>approx. 0,19 m²</p> <p>round:</p> <p>approx. 0,15 m²</p> <p>approx. 0,20 m²</p> <p>approx. 0,20 m²</p>
 corner element with round transition			

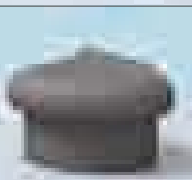
wedi Sanoasa Bellina ▪ end element left

	Description	Length × Width × Height	Order no.
 R = 200	wedi Sanoasa Bellina, bench end element left, R = 200, slope to front	486 × 300 × 240 mm	07-64-48/011
	wedi Sanoasa Bellina, carrier end element, R = 200	386 × 200 × 250 mm	07-64-48/013
 R = 486	wedi Sanoasa Bellina, bench end element left, R = 486, slope to front	600 × 486 × 240 mm	07-64-48/008
	wedi Sanoasa Bellina, carrier end element, R = 486	500 × 386 × 250 mm	07-64-48/010
	<p>! • The bench element shall be glued to the carrier element using wedi 610, adhesive sealant.</p> <p>• Delivery time is approx. 3 weeks ex-works.</p> <p>i The technical drawings for these products can be found in Chapter 14, Technology on Page 170.</p>	<p>m² Bench end element R = 200:</p> <p>▪ Front: approx. 0,30 m²</p> <p>▪ Rear panel: approx. 0,20 m²</p> <p>▪ Sides: approx. 0,19 m²</p> <p>Carrier end element R = 200:</p> <p>▪ Front: approx. 0,15 m²</p> <p>▪ Rear panel: approx. 0,15 m²</p> <p>▪ Sides: approx. 0,20 m²</p>	<p>R = 486:</p> <p>approx. 0,40 m²</p> <p>approx. 0,20 m²</p> <p>approx. 0,19 m²</p> <p>R = 486:</p> <p>approx. 0,20 m²</p> <p>approx. 0,25 m²</p> <p>approx. 0,20 m²</p>

wedi Sanoasa Bellina ■ end element right

	Description	Length × Width × Height	Order no.
 R = 200	wedi Sanoasa Bellina, bench end element right, R = 200, slope to front	486 × 300 × 240 mm	07-64-48/012
	wedi Sanoasa Bellina, carrier end element, R = 200	386 × 200 × 250 mm	07-64-48/013
 R = 486	wedi Sanoasa Bellina, bench end element right, R = 486, slope to front	600 × 486 × 240 mm	07-64-48/009
	wedi Sanoasa Bellina, carrier end element, R = 486	500 × 386 × 250 mm	07-64-48/010

- !** The bench element shall be glued to the carrier element using wedi 610, adhesive sealant.
- Delivery time is approx. 3 weeks ex-works.

i The technical drawings for these products can be found in Chapter 14, Technology on Page 171.

m ²	Bench corner element R = 200:	R = 486:
	• Front: approx. 0,30 m ²	approx. 0,40 m ²
	• Rear panel: approx. 0,20 m ²	approx. 0,20 m ²
	• Sides: approx. 0,19 m ²	approx. 0,19 m ²

	Carrier corner element R = 200:	R = 486:
	• Front: approx. 0,15 m ²	approx. 0,20 m ²
	• Rear panel: approx. 0,15 m ²	approx. 0,25 m ²
	• Sides: approx. 0,20 m ²	approx. 0,20 m ²

wedi Sanoasa Bellina ■ armrest

	Description	Length × Width × Height	Order no.
	wedi Sanoasa Bellina, armrest	550 × 105 × 650 mm	07-64-48/014

- !** The Sanoasa Bellina armrest can be installed equally on the right or the left.
- The armrest must be glued to the bench element and carrier element using wedi 610 adhesive sealant.
 - Delivery time is approx. 3 weeks ex-works.

i The technical drawing for this product can be found in Chapter 14, Technology on Page 171.

m ²	Armrest:
	• Front: approx. 0,65 m ²
	• Rear panel: approx. 0,10 m ²
	• Sides: approx. 0,72 m ²

wedi Sanoasa Lounger 1 ■ Lounger

	Description	Length × Width × Height	Order no.
	wedi Sanoasa Lounger 1, lounger without heating	1920 × 700 × 672 mm	07-64-00/042
	wedi Sanoasa Lounger 1, lounger with hot water heating	1920 × 700 × 672 mm	07-64-00/044
	wedi Sanoasa Lounger 1, lounger with electric heating	1920 × 700 × 672 mm	07-64-00/043
	Temperature controller of electrical heating, for installation on snap-on mounting rail		07-69-05/500
	Temperature controller of electrical heating, for concealed installation		07-69-06/000

- !** The delivery time for unheated loungers is approx. 5 weeks ex-works, and approx. 6 weeks ex-works for loungers with electrical or hot water heating.
- If you order a lounger with electrical heating, the heating will also be installed in the factory.
 - The lounger element shall be glued to the carrier element using wedi 610 adhesive sealant.

i The technical drawing for this product can be found in Chapter 14, Technology on Page 171.

m ²	Lounger:
	• Lounger element: approx. 4,15 m ²
	• Carrier element: approx. 0,47 m ²

wedi Sanoasa Lounger 2 ▪ Lounger



Description	Length × Width × Height	Order no.
wedi Sanoasa Lounger 2, lounger without heating	1442 × 700 × 1104 mm	07-64-00/045
wedi Sanoasa Lounger 2, lounger with hot water heating	1442 × 700 × 1104 mm	07-64-00/047
wedi Sanoasa Lounger 2, lounger with electric heating	1442 × 700 × 1104 mm	07-64-00/046
Temperature controller of electrical heating, for installation on snap-on mounting rail		07-69-05/500
Temperature controller of electrical heating, for concealed installation		07-69-06/000

- !** • The delivery time for unheated loungers is approx. 5 weeks ex-works, and approx. 6 weeks ex-works for loungers with electrical or hot water heating.
- If you order a lounger with electrical heating, the heating will also be installed in the factory.
 - The lounger element shall be glued to the carrier element using wedi 610 adhesive sealant.

i The technical drawing for this product can be found in Chapter 14, Technology on Page 172.

- m²** Lounger:
- Lounger element: approx. 2,33 m²
 - Carrier element: approx. 1,51 m²

wedi Sanoasa Lounger 3 ▪ Lounger



Description	Length × Width × Height	Order no.
wedi Sanoasa Lounger 3, lounger without heating	1856 × 700 × 764 mm	07-64-00/049
wedi Sanoasa Lounger 3, lounger with hot water heating	1856 × 700 × 764 mm	07-64-00/051
wedi Sanoasa Lounger 3, lounger with electric heating	1856 × 700 × 764 mm	07-64-00/050
Temperature controller of electrical heating, for installation on snap-on mounting rail		07-69-05/500
Temperature controller of electrical heating, for concealed installation		07-69-06/000

- !** • The delivery time for unheated loungers is approx. 5 weeks ex-works, and approx. 6 weeks ex-works for loungers with electrical or hot water heating.
- If you order a lounger with electrical heating, the heating will also be installed in the factory.
 - The lounger element shall be glued to the carrier element using wedi 610 adhesive sealant.

i The technical drawing for this product can be found in Chapter 14, Technology on Page 172.

- m²** Lounger:
- Lounger element: approx. 3,07 m²
 - Carrier element: approx. 1,28 m²

wedi Sanoasa Lounger 4 ■ Lounger



Description	Length × Width × Height	Order no.
wedi Sanoasa Lounger 4, lounger without heating	2014 × 700 × 921 mm	07-64-00/053
wedi Sanoasa Lounger 4, lounger with hot water heating	2014 × 700 × 921 mm	07-64-00/055
wedi Sanoasa Lounger 4, lounger with electric heating	2014 × 700 × 921 mm	07-64-00/054
Temperature controller of electrical heating, for installation on snap-on mounting rail		07-69-05/500
Temperature controller of electrical heating, for concealed installation		07-69-06/000

- !** The delivery time for unheated loungers is approx. 5 weeks ex-works, and approx. 6 weeks ex-works for loungers with electrical or hot water heating.
- If you order a lounger with electrical heating, the heating will also be installed in the factory.
 - The lounger element shall be glued to the carrier element using wedi 610 adhesive sealant.

i The technical drawing for this product can be found in Chapter 14, Technology on Page 172.

- m²** Lounger:
- Lounger element: approx. 3,18 m²
 - Carrier element: approx. 3,05 m²

wedi Sanoasa Lounger 5 ■ Lounger



Description	Length × Width × Height	Order no.
wedi Sanoasa Lounger 5, lounger without heating	1738 × 700 × 890 mm	07-64-00/059
wedi Sanoasa Lounger 5, lounger with hot water heating	1738 × 700 × 890 mm	07-64-00/061
wedi Sanoasa Lounger 5, lounger with electric heating	1738 × 700 × 890 mm	07-64-00/060
Temperature controller of electrical heating, for installation on snap-on mounting rail		07-69-05/500
Temperature controller of electrical heating, for concealed installation		07-69-06/000

- !** The delivery time for unheated loungers is approx. 5 weeks ex-works, and approx. 6 weeks ex-works for loungers with electrical or hot water heating.
- If you order a lounger with electrical heating, the heating will also be installed in the factory.

i The technical drawing for this product can be found in Chapter 14, Technology on Page 172.

- m²** Lounger:
- Lounger element inkl. carrier element: approx. 4,16 m²

wedi Sanbath Cube ▪ tub

	Description	Length × Width × Height	Packing unit	Order no.
	wedi Sanbath Cube, tub	1800 × 850 × 625 mm	1 unit	07-36-07/001
	<p>! The delivery time is approx. 4 – 5 weeks ex-works.</p> <p>👑 1 Bathtub element with drain and overflow fitting, connection DN 40/50, inspection chamber for provided fittings</p> <ul style="list-style-type: none"> ▪ Fundo Fino 5.1 drain grid ▪ Fundo Fino frame <p>i The technical drawing for this product can be found in Chapter 14, Technology on Page 173.</p>		<p>m² Sanbath Cube, tub:</p> <ul style="list-style-type: none"> ▪ Inside: approx. 2,80 m² ▪ Engraved round outside edge: approx. 3,30 m² 	

wedi Sanbath Cube ▪ wash stand

	Description	Length × Width × Height	Packing unit	Order no.
	wedi Sanbath Cube, wash stand	570 × 570 × 925 mm	1 unit	07-36-06/000
	<p>! The wash basin is prepared for installation of siphon (1 ¼") and fittings.</p> <p>The delivery time is approx. 4 – 5 weeks ex-works.</p> <p>👑 1 wash stand</p> <ul style="list-style-type: none"> ▪ 1 × siphon, connection DN 50 <p>i The technical drawing for this product can be found in Chapter 14, Technology on Page 173.</p>		<p>m² Sanbath Cube, wash stand:</p> <ul style="list-style-type: none"> ▪ Top + Inside: approx. 0,60 m² ▪ Engraved round outside edge: approx. 2,00 m² 	

wedi Sanbath Cube ▪ shower unit

	Description	Length × Width × Height	Packing unit	Order no.
	wedi Sanbath Cube, shower unit	2200 × 400 × 850 mm	1 unit	07-36-05/000
	<p>! The delivery time is approx. 4 – 5 weeks ex-works.</p> <p>👑 1 shower unit element with 1 hansgrohe iBox (with prefabricated piping for a head shower)</p> <p>i The technical drawing for this product can be found in Chapter 14, Technology on Page 173.</p>		<p>m² Sanbath Cube, shower unit:</p> <ul style="list-style-type: none"> ▪ Front + sides + top: approx. 3,30 m² 	

wedi Sanbath Wave ▪ tub

	Description	Length × Width × Height	Packing unit	Order no.
	wedi Sanbath Wave, tub	1800 × 850 × 625 mm	1 unit	07-36-01/001
	<p>! The delivery time is approx. 4 – 5 weeks ex-works.</p> <p>👑 1 Bathtub element with drain and overflow fitting, connection DN 40/50, inspection chamber for provided fittings</p> <ul style="list-style-type: none"> ▪ Fundo Fino 5.1 drain grid ▪ Fundo Fino frame <p>i The technical drawing for this product can be found in Chapter 14, Technology on Page 174.</p> <p>m² Sanbath Wave, tub:</p> <ul style="list-style-type: none"> ▪ Inside: approx. 2,90 m² ▪ Engraved round outside edge: approx. 3,40 m² 			

wedi Sanbath Wave ▪ wash basin

	Description	Length × Width × Height	Packing unit	Order no.
	wedi Sanbath Wave, wash basin	1000 × 550 × 200 mm	1 unit	07-36-03/000
	<p>! The wash basin is prepared for installation of siphon (1 ¼") and fittings.</p> <p>The delivery time is approx. 4 – 5 weeks ex-works.</p> <p>👑 1 wash basin element</p> <ul style="list-style-type: none"> ▪ 1 wall fixing (only for flush-mounted fitting) <p>i The technical drawing for this product can be found in Chapter 14, Technology on Page 174.</p> <p>m² Sanbath Wave, wash basin:</p> <ul style="list-style-type: none"> ▪ Engraved round outside edge: approx. 1,50 m² 			

wedi Sanbath Wave ▪ shower unit

	Description	Length × Width × Height	Packing unit	Order no.
	wedi Sanbath Wave, shower unit	2500 × 1010,5 × 400 mm	1 unit	07-36-02/000
	<p>! The delivery time is approx. 4 – 5 weeks ex-works.</p> <p>👑 1 shower unit element with 1 hansgrohe iBox (with prefabricated piping for a head shower)</p> <p>i The technical drawing for this product can be found in Chapter 14, Technology on Page 174.</p> <p>m² Sanbath Wave, shower unit:</p> <ul style="list-style-type: none"> ▪ Front + Sides: approx. 2,06 m² ▪ Top: approx. 0,84 m² 			

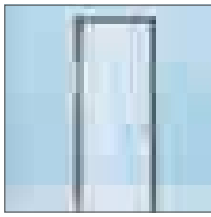
wedi Eterna ▪ glass door with stainless steel frame V₄A

Description	Door stop	for wall thickness	Fold dimensions Width × Height	Packing unit	Order no.
wedi Eterna, glass door with stainless steel frame	DIN right	80 mm	591 × 1983 mm	1 unit	67-65-00/010
wedi Eterna, glass door with stainless steel frame	DIN right	80 mm	716 × 1983 mm	1 unit	67-65-00/011
wedi Eterna, glass door with stainless steel frame	DIN right	50 mm	591 × 1983 mm	1 unit	67-65-00/012
wedi Eterna, glass door with stainless steel frame	DIN right	80 mm	966 × 1983 mm	1 unit	67-65-00/013
wedi Eterna, glass door with stainless steel frame	DIN left	80 mm	591 × 1983 mm	1 unit	67-65-00/014
wedi Eterna, glass door with stainless steel frame	DIN left	80 mm	716 × 1983 mm	1 unit	67-65-00/015
wedi Eterna, glass door with stainless steel frame	DIN left	50 mm	591 × 1983 mm	1 unit	67-65-00/016
wedi Eterna, glass door with stainless steel frame	DIN left	80 mm	966 × 1983 mm	1 unit	67-65-00/017

i The technical drawing for this product can be found in Chapter 14, Technology on Page 175.

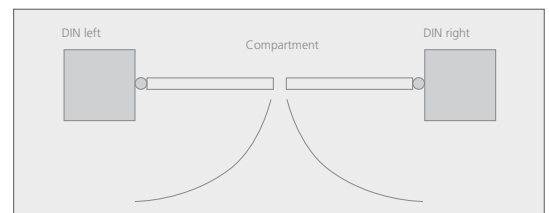



12

13

14

13

Spa and wellness projects

The wish for extravagant design concepts for individual wellness landscapes is growing among many complex operators. Starting with the simple shower, through to unusual designer items, the requirements on planners, architects and system builders are also increasing constantly. wedi offers real support here: After the initial idea and planning, the requested wellness items are developed, which can then be supplied complete and ready to assemble. wedi is also available to supply competent advice when it comes to choosing the lighting concept, possible heating systems and sound or shower technology. Talk to us and let us help you create your individual wellness complex.

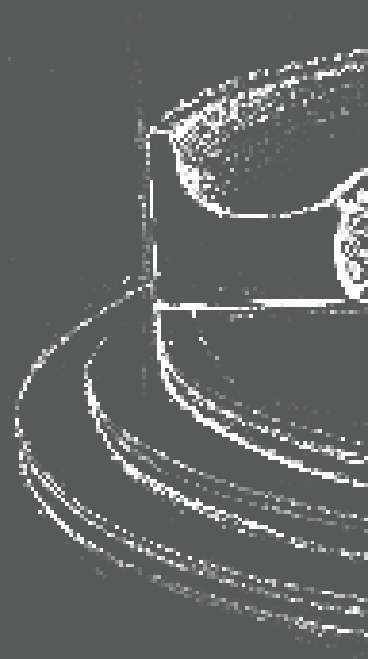

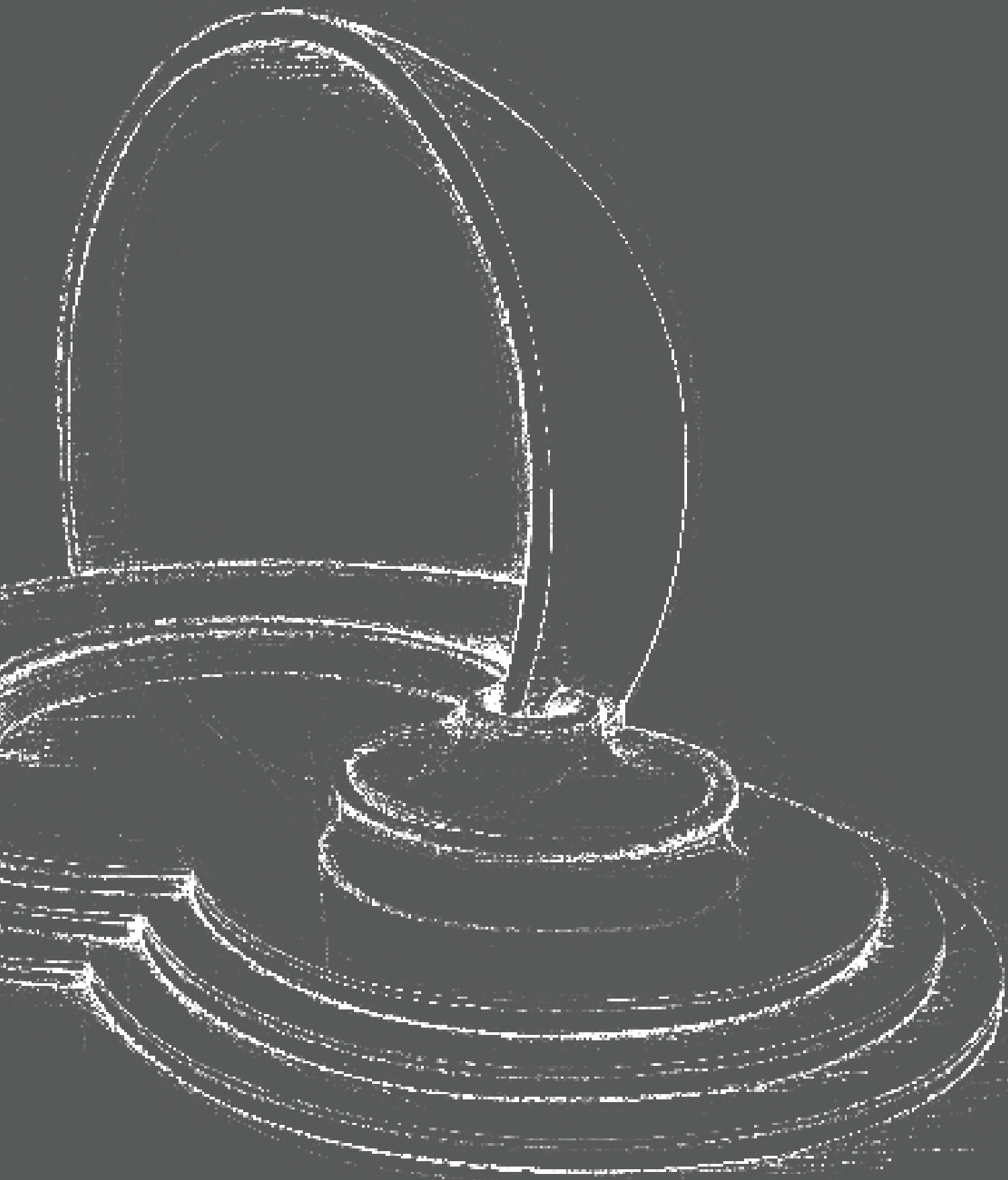

Customer-specific construction examples



Multi-sensory showers / shower systems
Example 1



Multi-sensory showers / shower systems
Example 2



Steam bath / hamam
Example 1



Steam bath / hamam
Example 2



Whirlpools / pools / plunge pools
Example 1

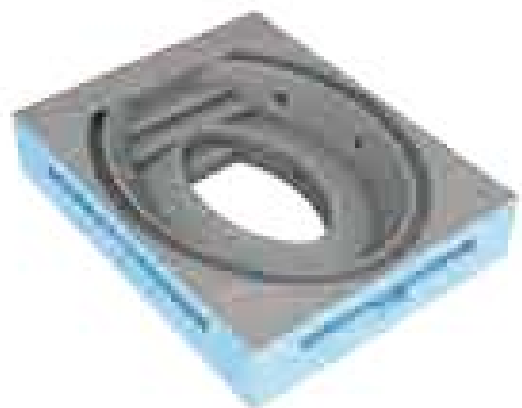

Whirlpools / pools / plunge pools
Example 2



Benches & loungers
Example



Fountain elements
Example



Furniture & design elements
Example 1



Furniture & design elements
Example 2

Every compartment design, every room concept, every wellness project

wedi manufactures customised solutions to customer request. For the planners, architects and builders of a wellness or hotel system, this means: From the design, planning and production of the individual components to the on-site installation, wedi is available to you as a key point of contact for all questions in every phase of the project.

As a systems provider and premium brand, we attribute considerable value to quality: Quality with the products and systems, quality with the employees and quality in the dialogue with you. We guarantee you a professional approach with every project and look forward to accepting your challenge.

Talk to us!

Telephone: + 49 25 72 156-0
 Fax: + 49 25 72 156-239
 E-Mail: project@wedi.de
 Web: www.wedi.eu

Examples spa and wellness projects





Examples spa and wellness projects





14

Technical information

The wedi system environment contains a multitude of individual elements, which can be used for a wide range of uses or can be expanded into complete modular systems. So that you can plan your bathroom design right on target, you will find an overview of the formats, dimensions and technical requirements for the individual products over the following pages. Furthermore, you will find some design suggestions with compatible wedi system elements. So you're always on the safe side.



wedi Moltoromo ■ straight wall segment

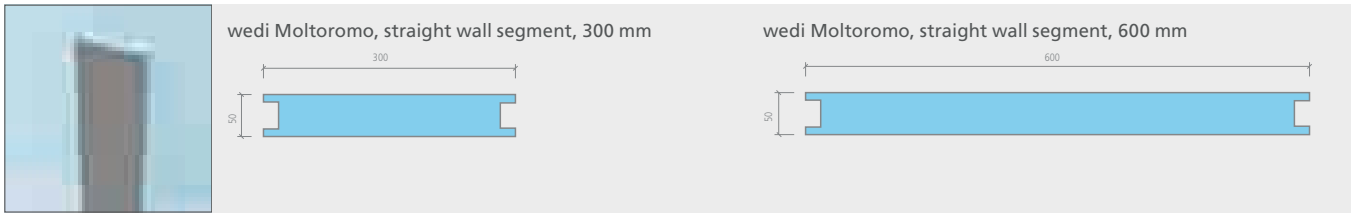

wedi Moltoromo ■ angled wall segment

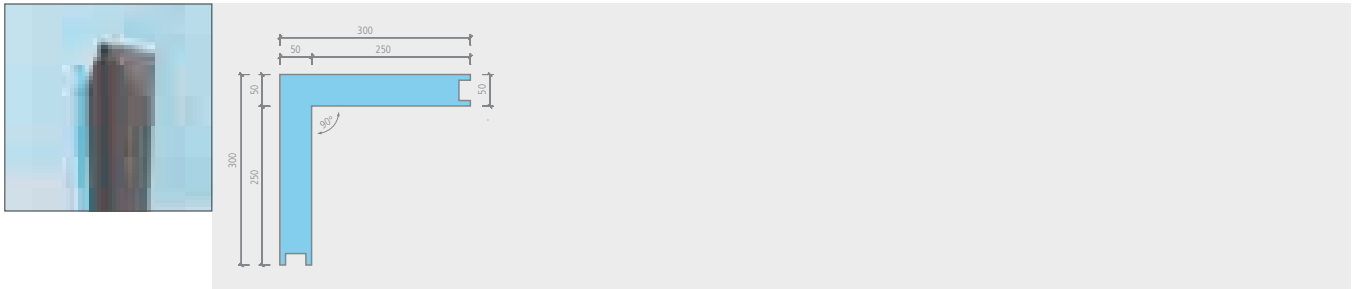

wedi Moltoromo ■ curved wall segment

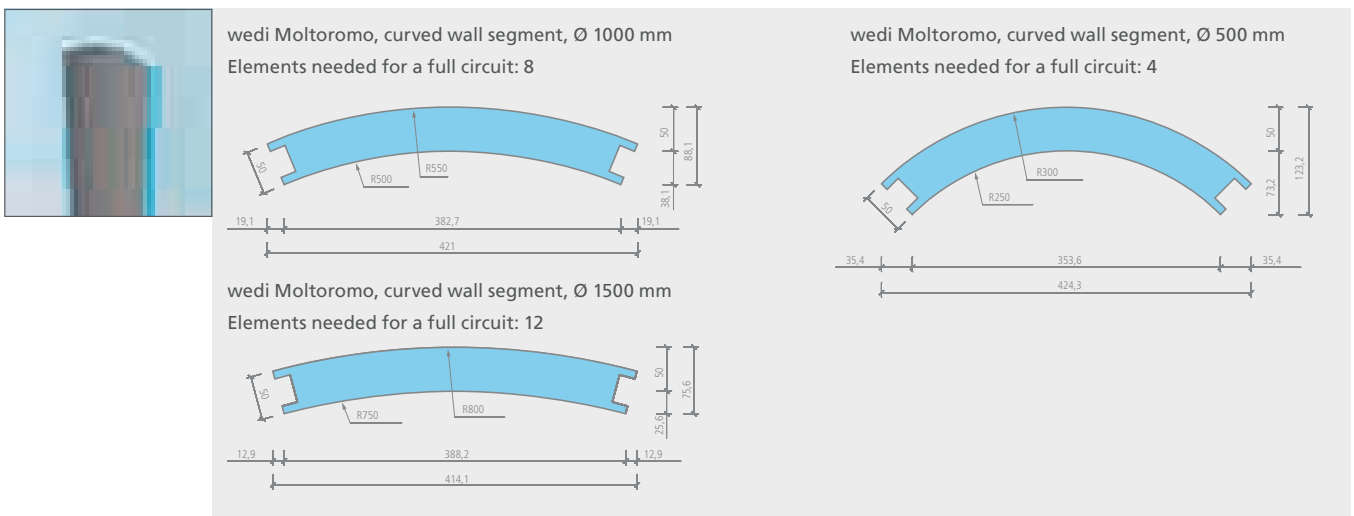

wedi Moltoromo ■ straight duct segment

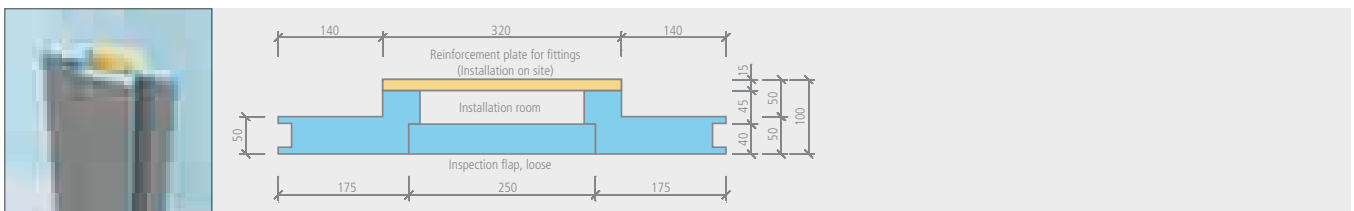

wedi Moltoromo ▪ angled duct segment

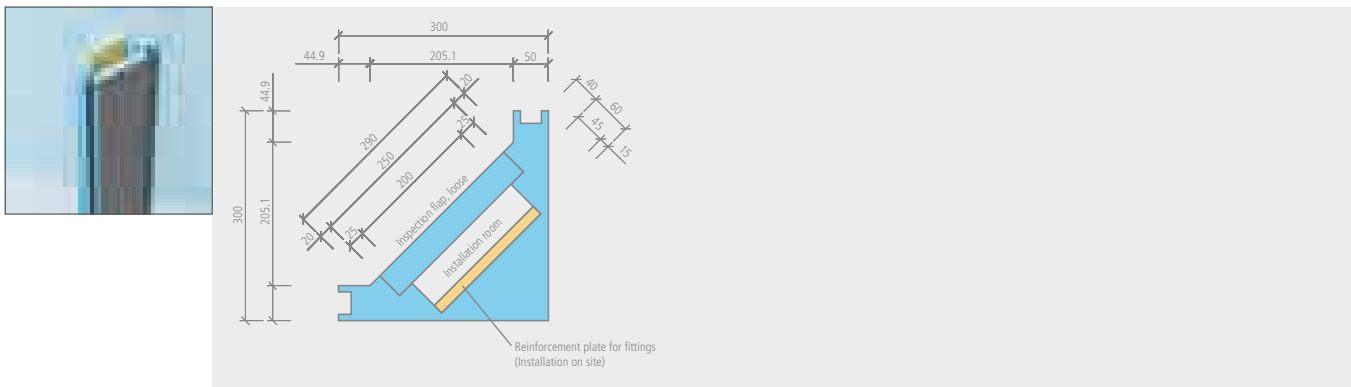

wedi Moltoromo ▪ curved duct segment

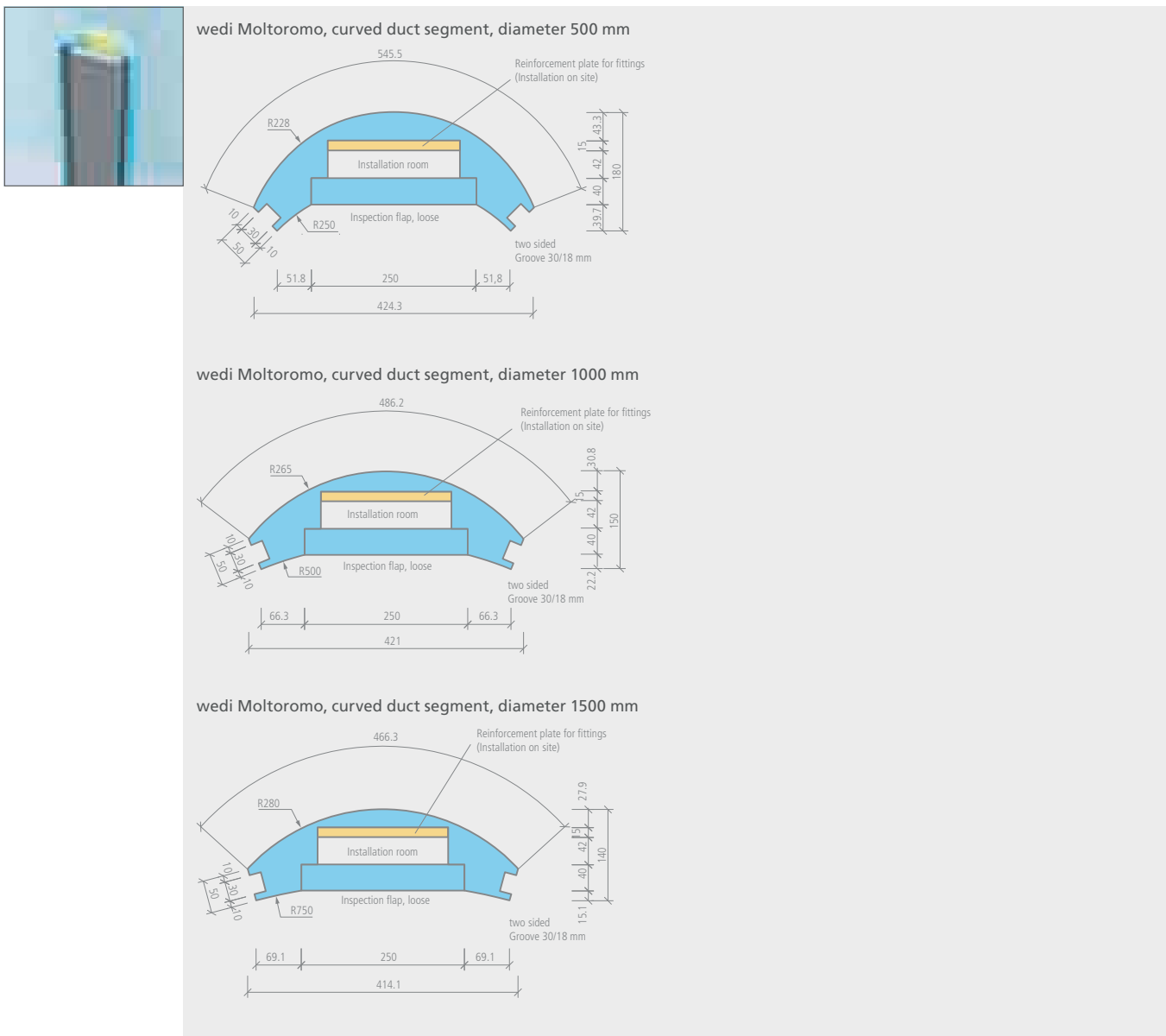

wedi Moltoromo ■ corner profile

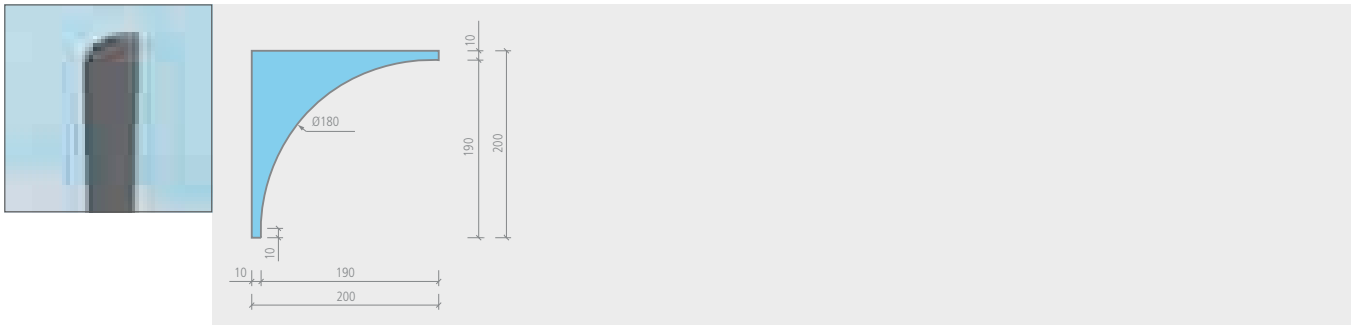

wedi Moltoromo ■ end profile

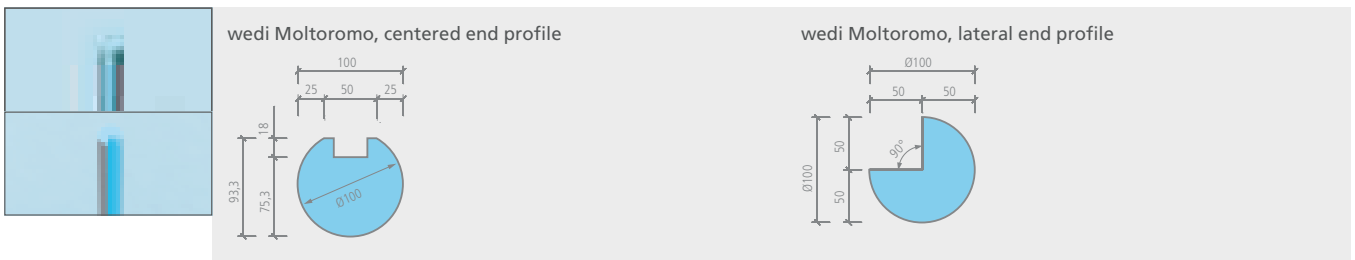

Fundo Top Primo ■ ready-to-use surface

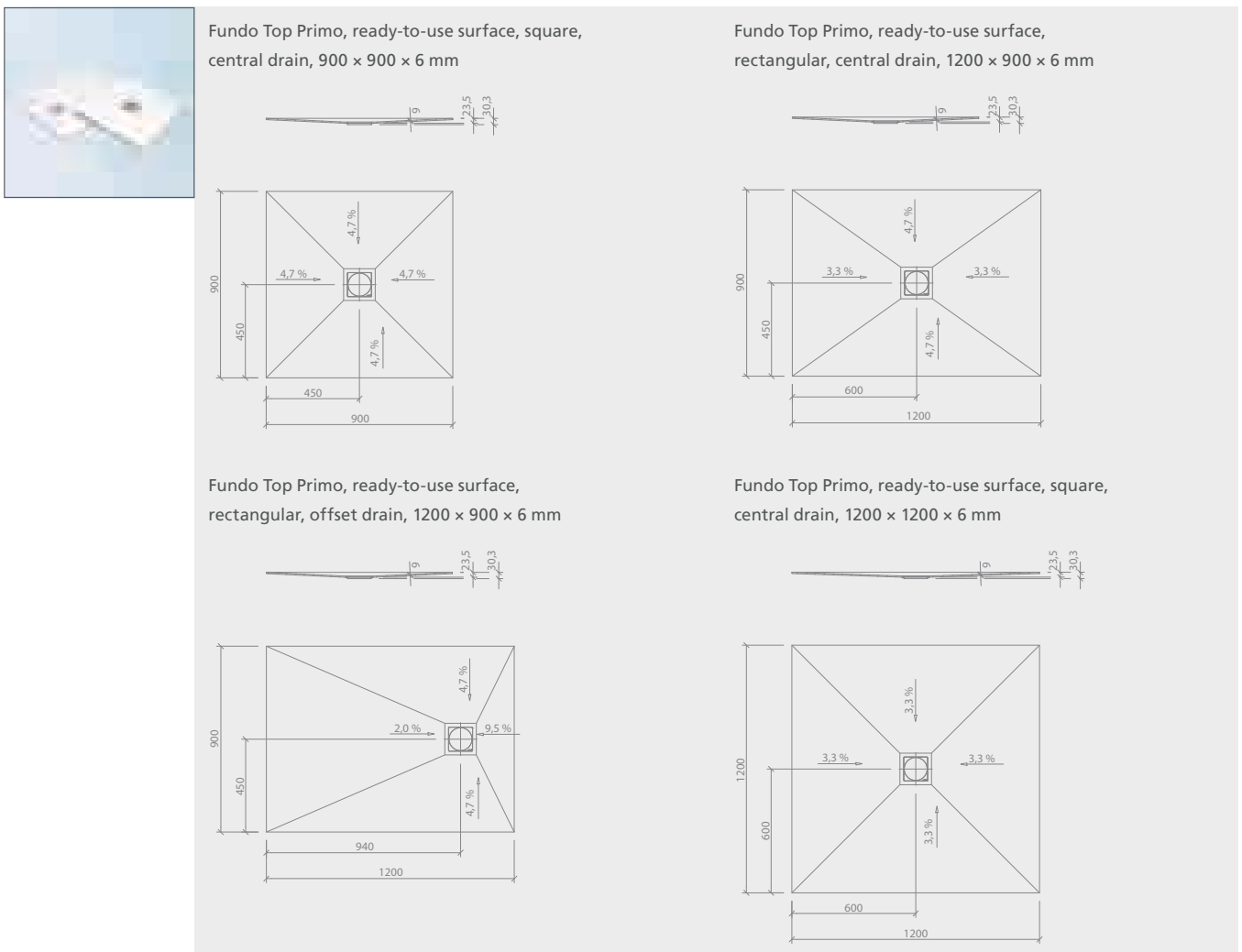

Fundo Top Primo ■ ready-to-use surface

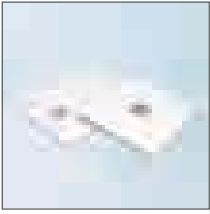

Fundo Top Primo, ready-to-use surface,
rectangular, central drain, 1800 × 900 × 6 mm

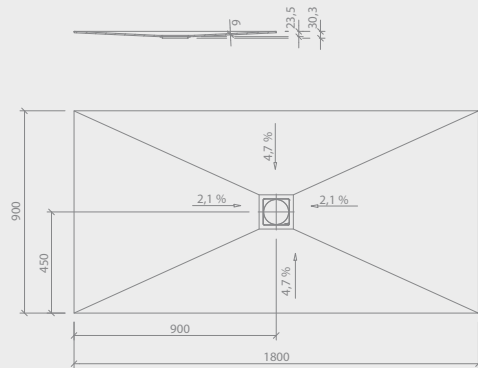

Fundo Top Primo, ready-to-use surface,
rectangular, offset drain, 1800 × 900 × 6 mm

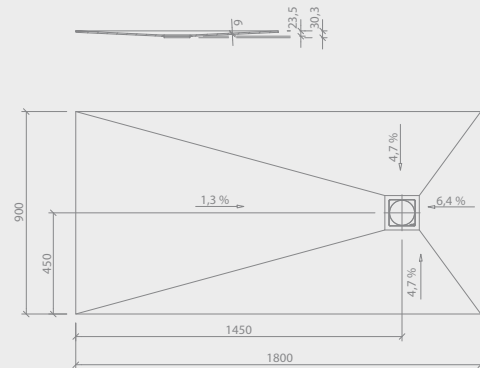

Fundo Top Plano ■ ready-to-use surface

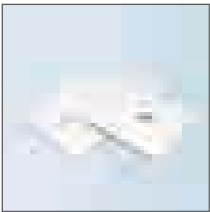

Fundo Top Plano, ready-to-use surface,
square, central drain, 900 × 900 × 6 mm

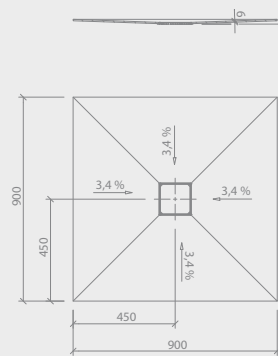

Fundo Top Plano, ready-to-use surface,
rectangular, central drain, 1200 × 900 × 6 mm

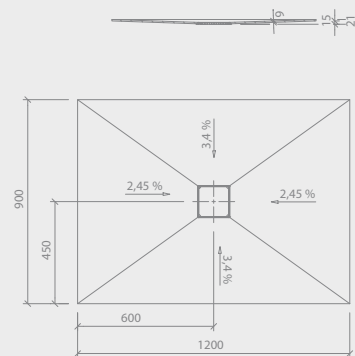

Fundo Top Plano, ready-to-use surface,
rectangular, offset drain, 1600 × 1000 × 6 mm

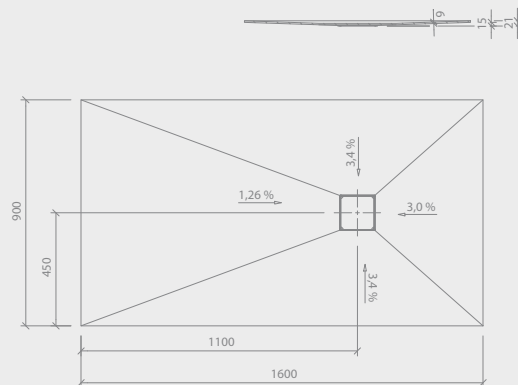

Fundo Top Riolito neo ■ ready-to-use surface

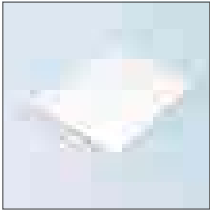

Fundo Top Riolito neo, ready-to-use surface,
rectangular, 1200 × 900 × 6 mm

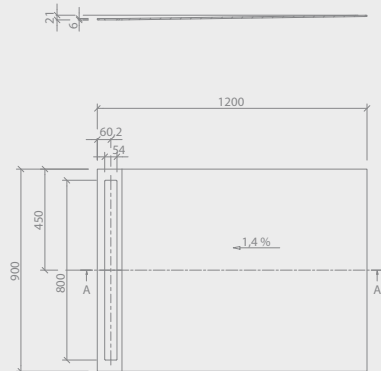

Fundo Top Riolito neo, ready-to-use surface,
rectangular, 1600 × 1000 × 6 mm

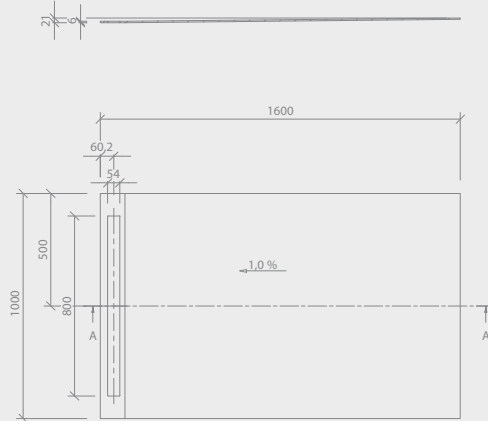

Fundo Top Riolito neo, ready-to-use surface,
rectangular, 1800 × 900 × 6 mm

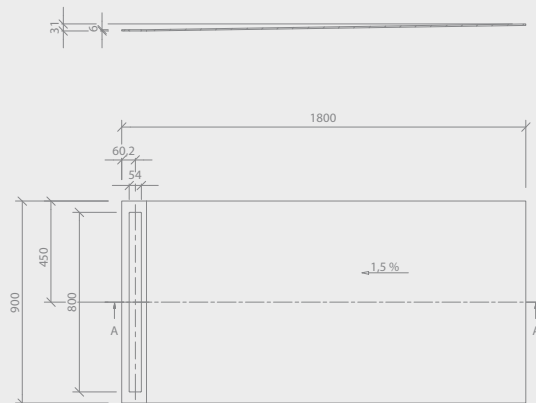

Fundo Primo ■ floor element

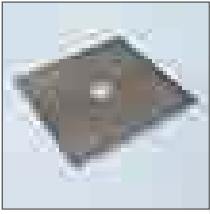

Fundo Primo, floor element square, central drain, 900 × 900 × 40 mm

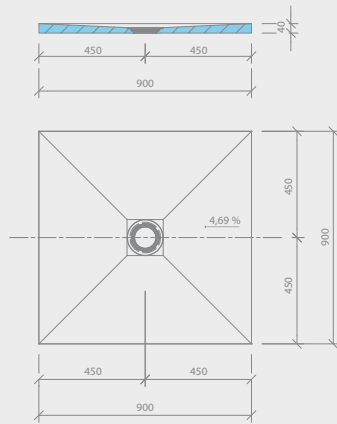

Fundo Primo, floor element square, central drain, 1000 × 1000 × 40 mm

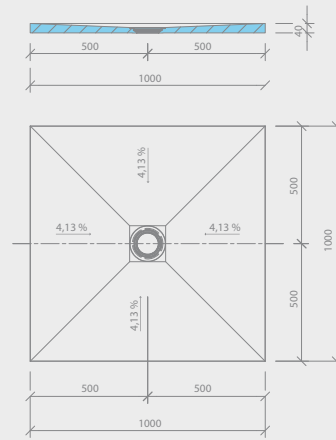

Fundo Primo, floor element square, central drain, 1200 × 1200 × 40 mm

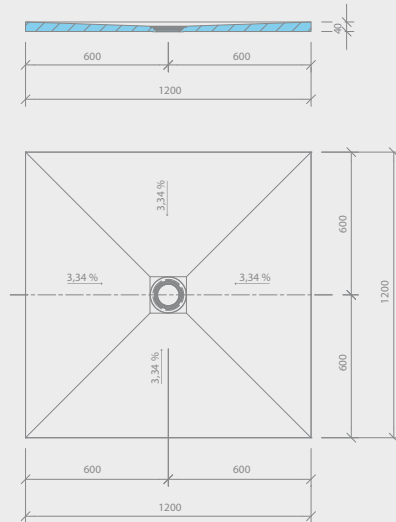

Fundo Primo, floor element square, central drain, 1500 × 1500 × 40 mm

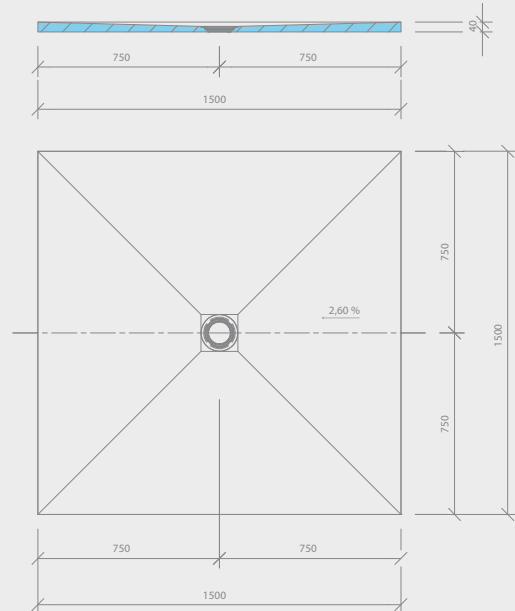

Fundo Primo, floor element square, corner drain, 900 × 900 × 40 mm

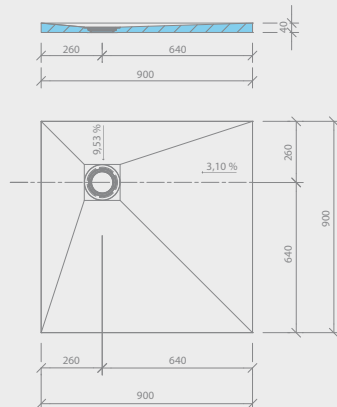

Fundo Primo, floor element square, corner drain, 1000 × 1000 × 40 mm

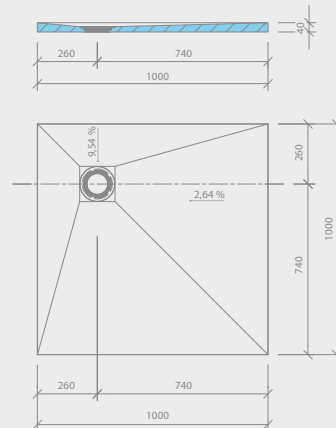

Fundo Primo ■ floor element

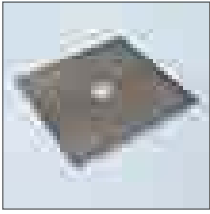

Fundo Primo, floor element square, corner drain, 1200 × 1200 × 40 mm

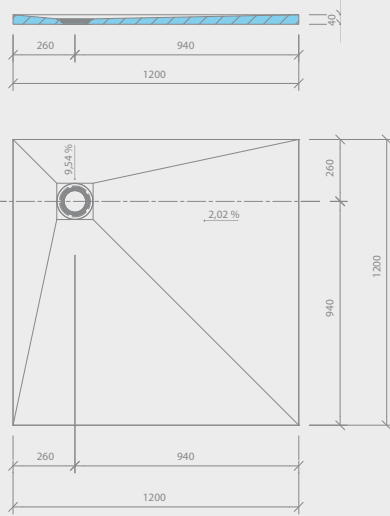

Fundo Primo, floor element square, corner drain, 1500 × 1500 × 40 mm

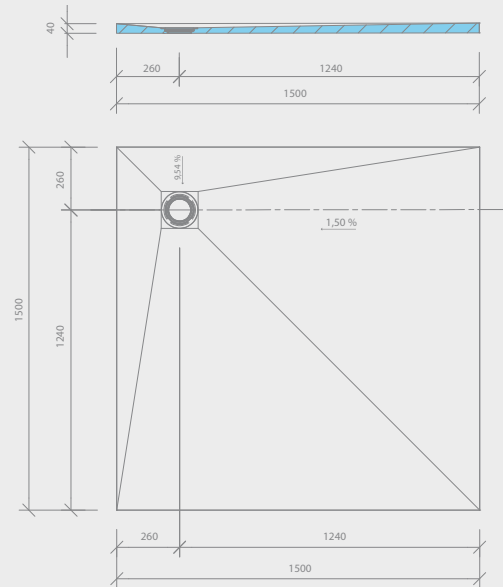

Fundo Primo, floor element rectangular, central drain, 900 × 750 × 40 mm

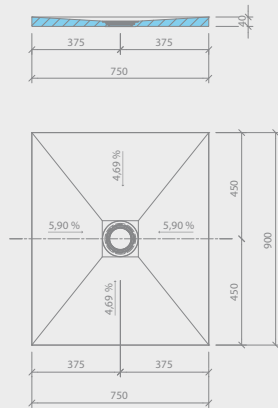

Fundo Primo, floor element rectangular, central drain, 1200 × 900 × 40 mm

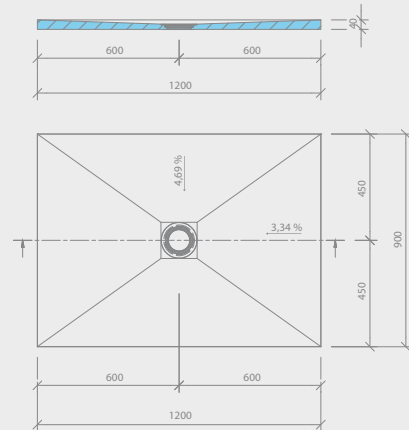

Fundo Primo, floor element rectangular, central drain, 1400 × 900 × 40 mm

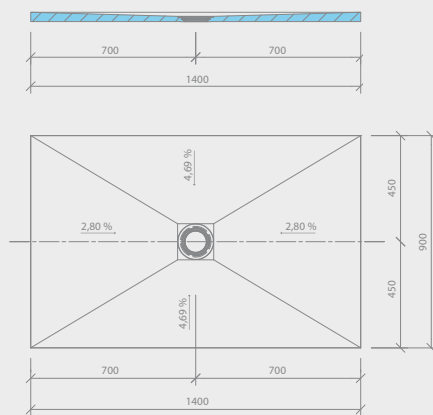

Fundo Primo, floor element rectangular, central drain, 1500 × 900 × 40 mm

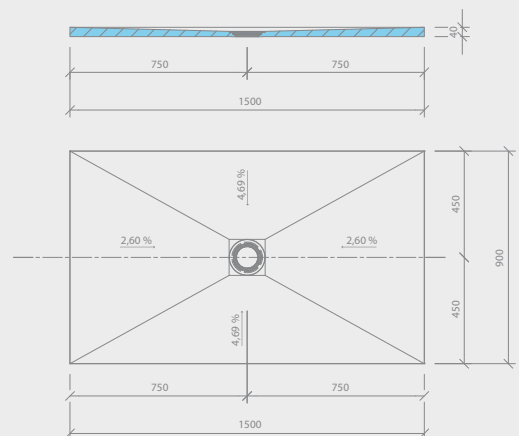

Fundo Primo ■ floor element

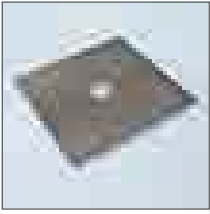

Fundo Primo, floor element rectangular, central drain, 1800 × 900 × 40 mm

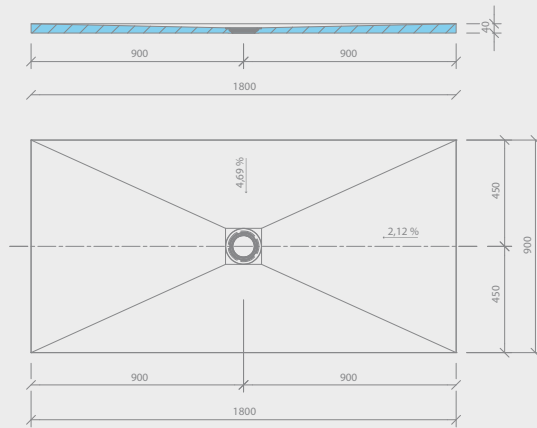

Fundo Primo, floor element rectangular, central drain, 1400 × 1000 × 40 mm

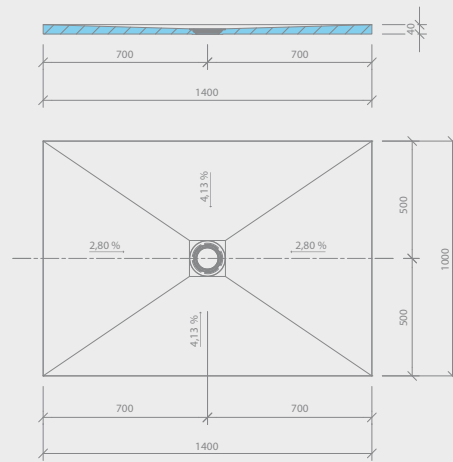

Fundo Primo, floor element rectangular, central drain, 1500 × 1000 × 40 mm

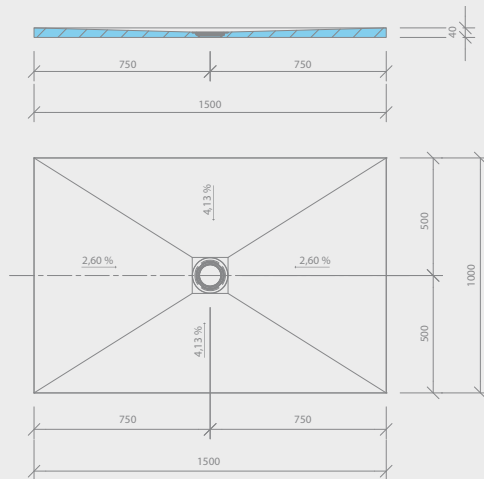

Fundo Primo, floor element rectangular, offset drain, 1200 × 900 × 40 mm

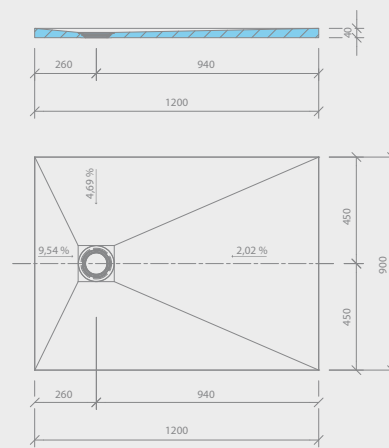

Fundo Primo, floor element rectangular, offset drain, 1400 × 900 × 40 mm

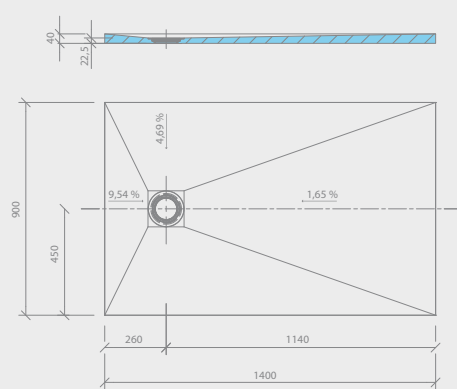

Fundo Primo, floor element rectangular, offset drain, 1600 × 900 × 40 mm

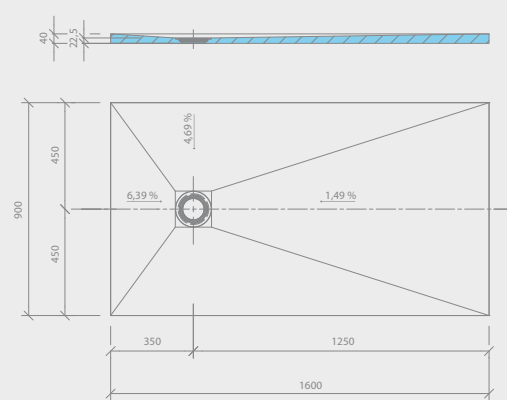

Fundo Primo ■ floor element

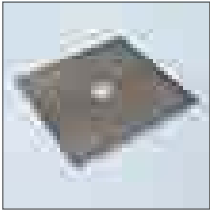

Fundo Primo, floor element rectangular, offset drain, 1800 × 900 × 40 mm

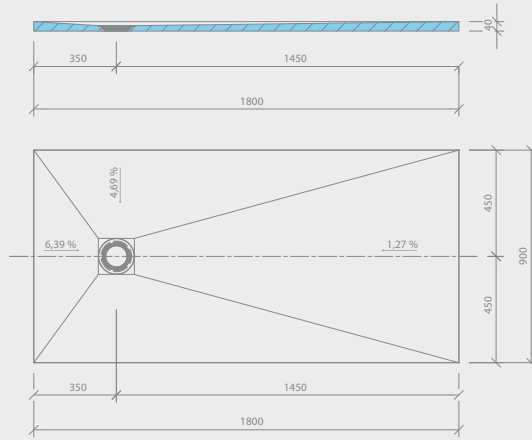

Fundo Primo, floor element rectangular, offset drain, 1600 × 1000 × 40 mm

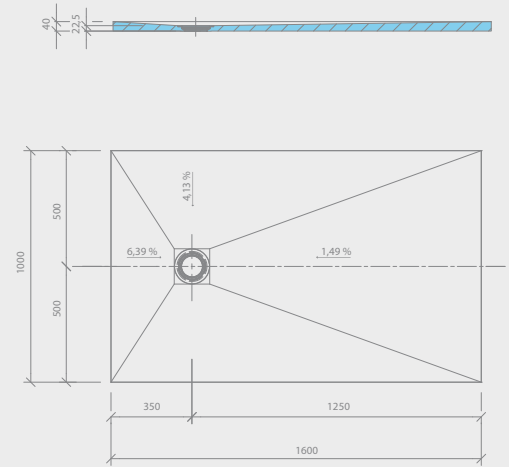

Fundo Primo ■ special floor element

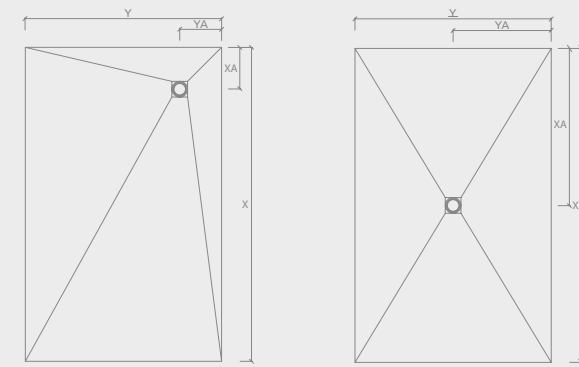

wedi Fundo Individual ■ special floor element

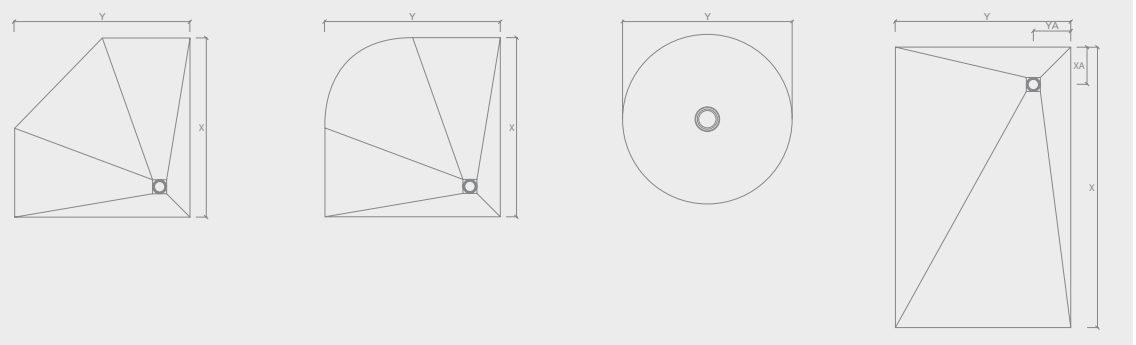

wedi sloping board ▪ Fundo Primo

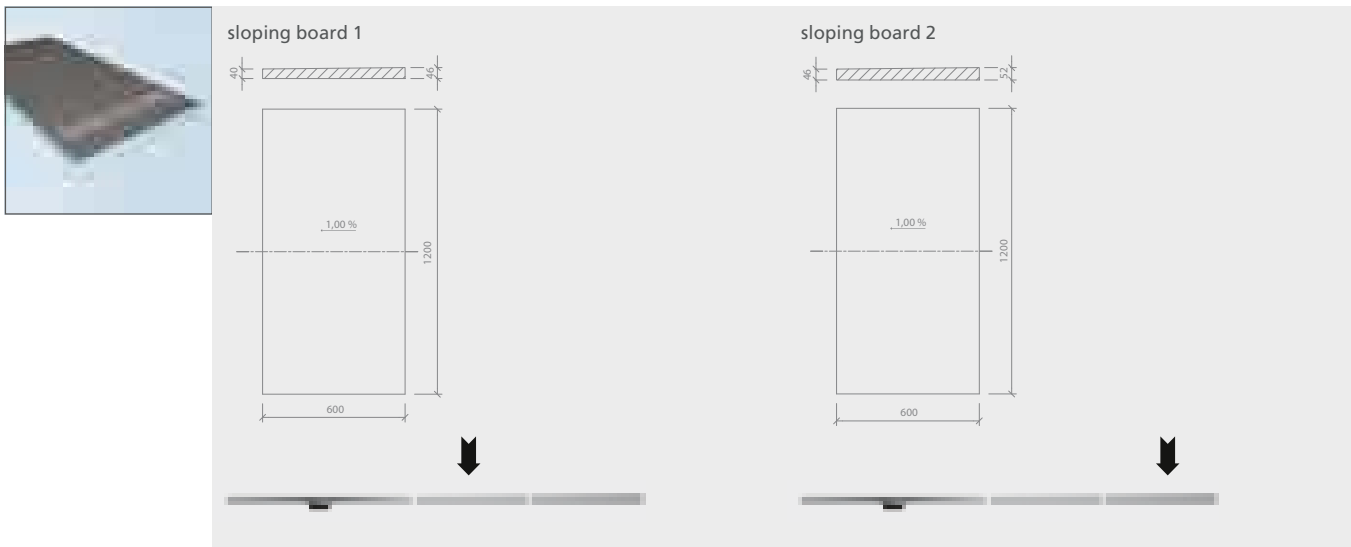

Fundo Borgo ▪ floor element, corner drain

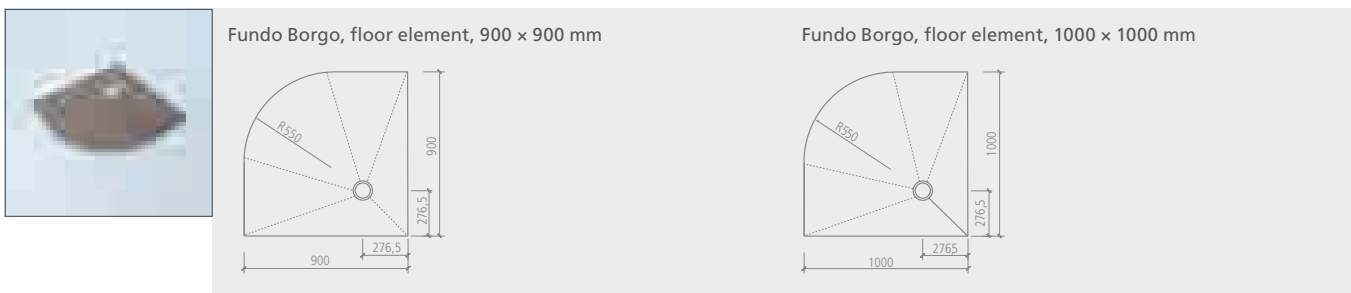

Fundo Trollo ▪ floor element, central drain

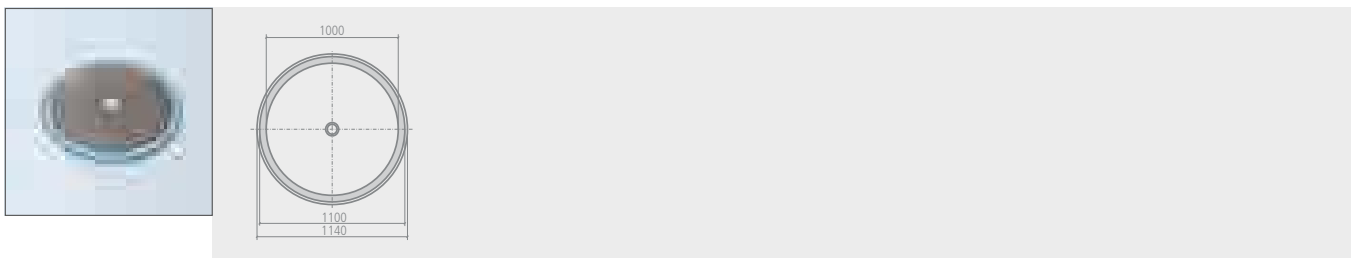

Fundo Trollo ▪ wall element



Fundo Trollo, wall element

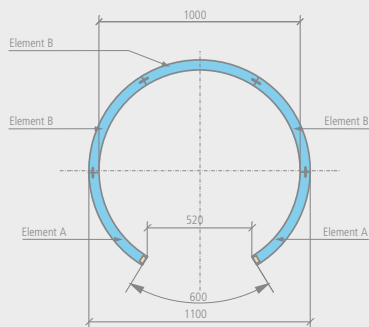
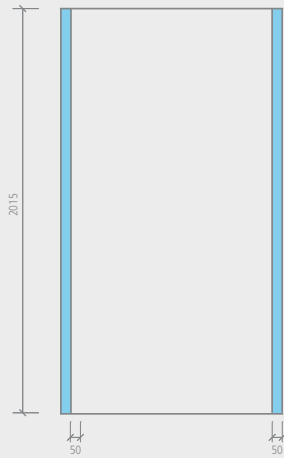

Fundo Trollo, extension collar

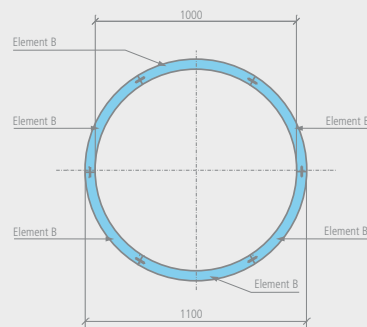
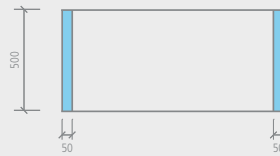

Fundo Trollo libero ▪ wall element



Fundo Trollo libero, designer shower

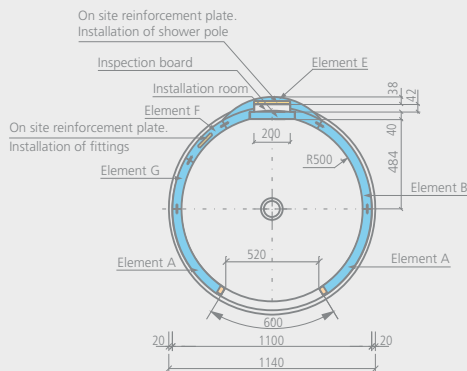
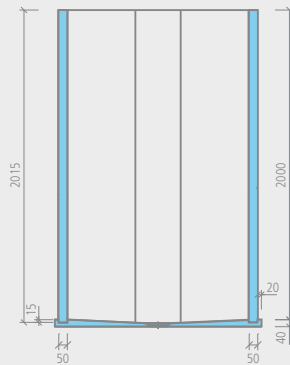

Fundo Trollo libero, extension collar

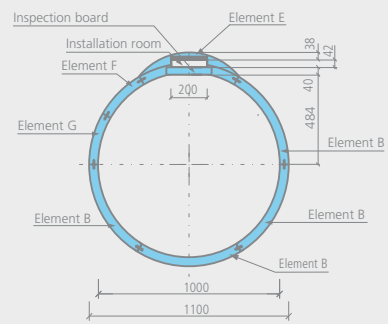
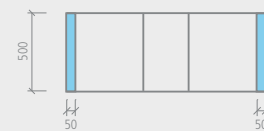

Fundo Nautilo ▪ floor element



Fundo Nautilo, right entry

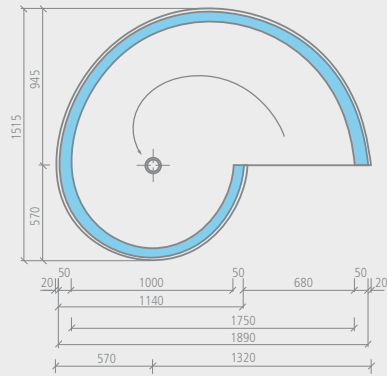

Fundo Nautilo, left entry

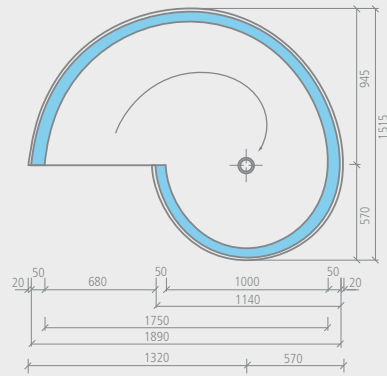

Fundo Nautilo ▪ wall element

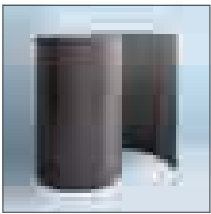

Fundo Nautilo, wall element

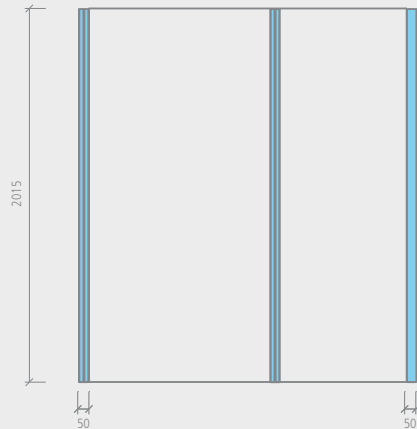

Fundo Nautilo, extension collar

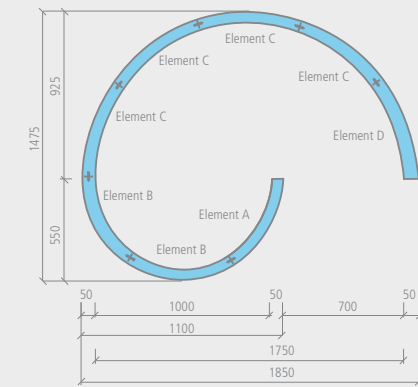
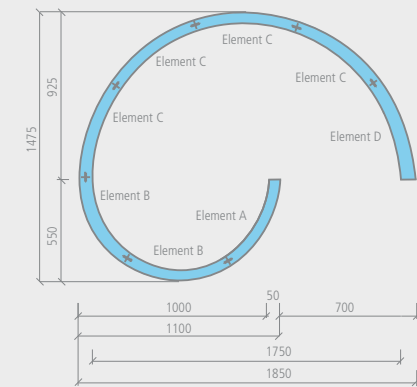
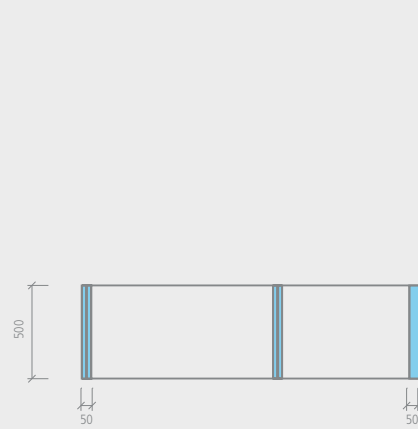

Fundo Nautilo libero ■ wall element



Fundo Nautilo libero, designer shower

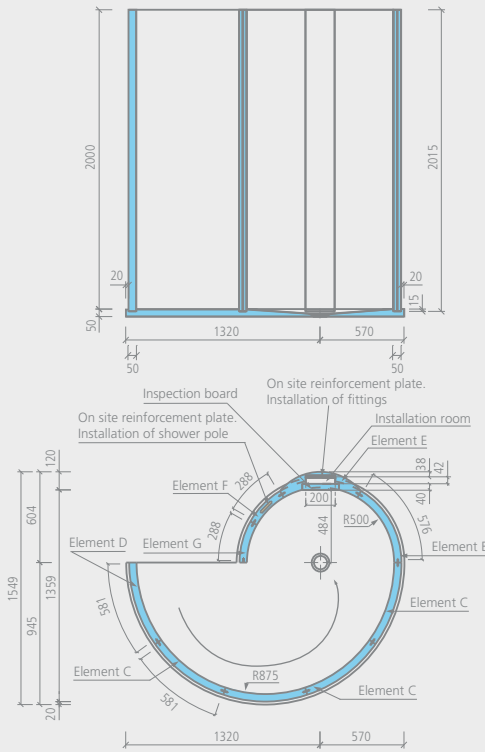

Fundo Nautilo libero, extension collar

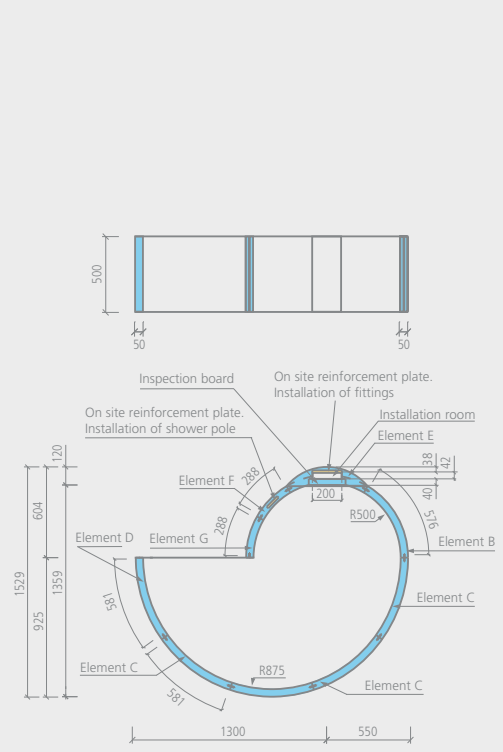

wedi Fundo vertical drain ■ DN 50

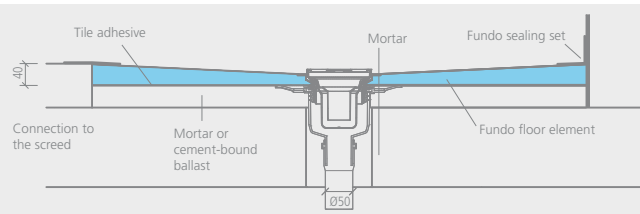
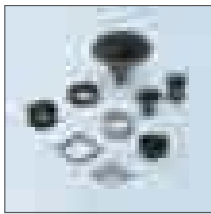

Absorption capacity: 1,10 Litre/Second
Core drilling diameter: 120 mm

wedi Fundo vertical drain ■ DN 50 with fire protection collar

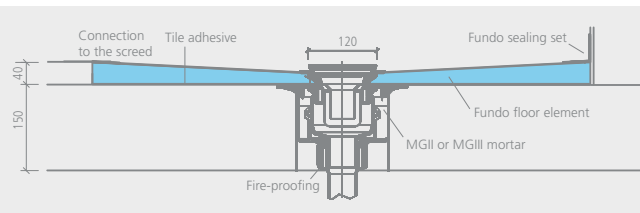

Absorption capacity: 1,00 Litre/Second
Core drilling diameter: 160 mm

wedi Fundo vertical drain ■ DN 70

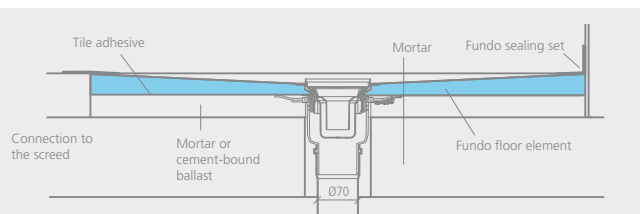
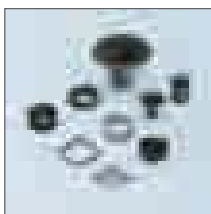

Absorption capacity: 0,80 Litre/Second
Core drilling diameter: 120 mm

wedi Fundo horizontal drain ■ DN 50

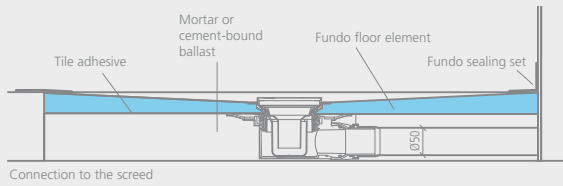

Absorption capacity: 0,80 Litre/Second

wedi Fundo drain Mini Max ■ DN 40, extra flat

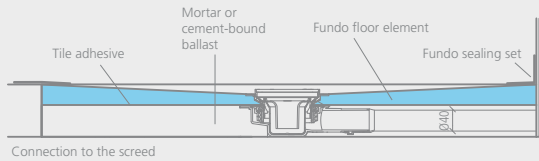

Absorption capacity: 0,50 Litre/Second

Fundo Primo Easy Set

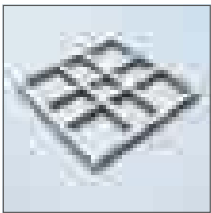

Fundo Primo Easy Set, square, central drain, 900 × 900 × 100 mm

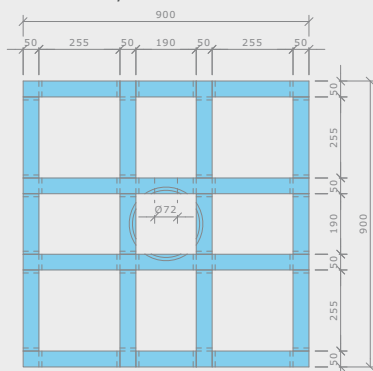

Fundo Primo Easy Set, square, central drain, 1000 × 1000 × 100 mm

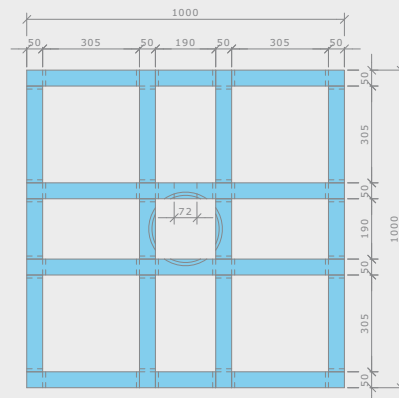

Fundo Primo Easy Set, square, central drain, 1200 × 1200 × 100 mm

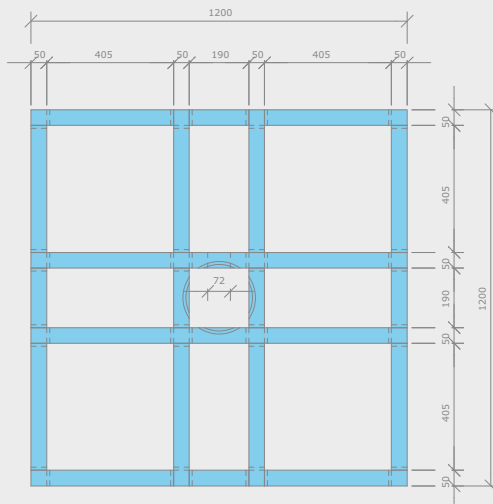

Fundo Primo Easy Set, square, central drain, 1500 × 1500 × 100 mm

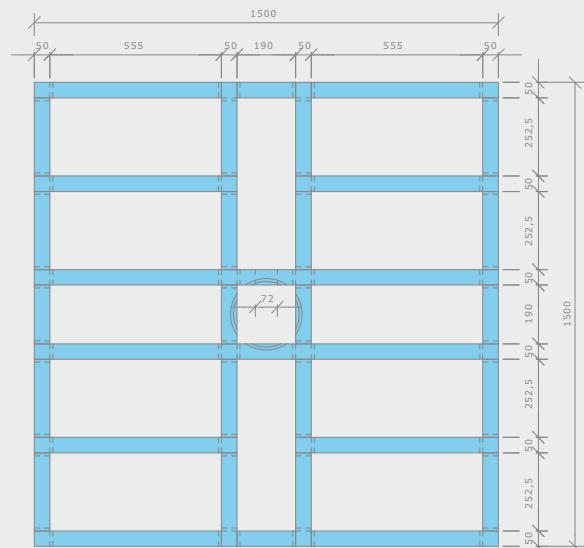

Fundo Primo Easy Set



Fundo Primo Easy Set, rectangular,
central drain, 1200 × 900 × 100 mm

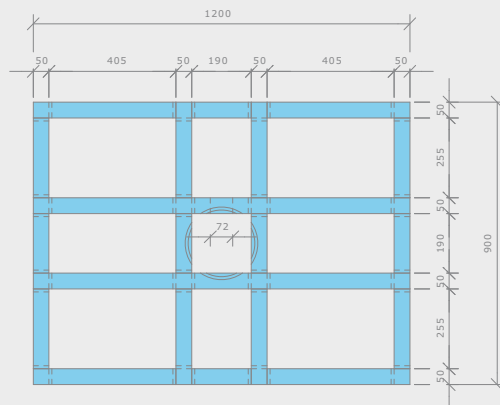

Fundo Primo Easy Set, rectangular,
central drain, 1800 × 900 × 100 mm

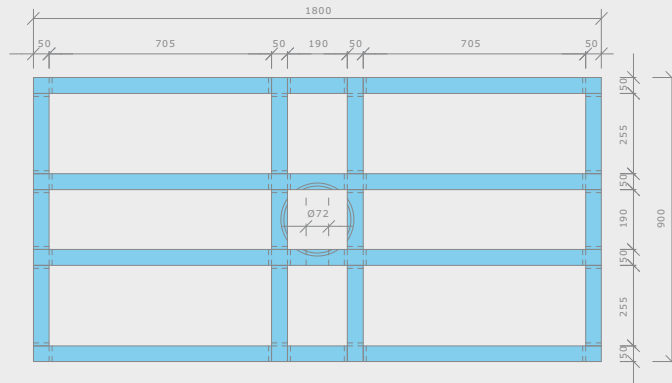

Fundo Primo Easy Set, rectangular,
offset drain, 1200 × 900 × 100 mm

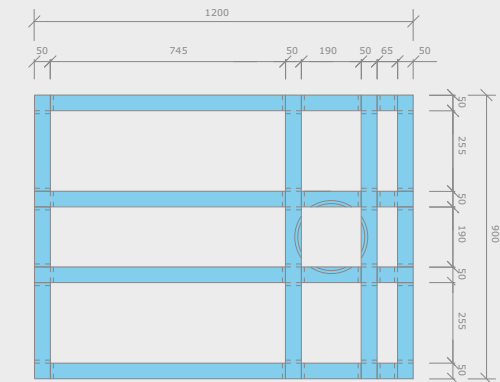

Fundo Primo Easy Set



Fundo Primo Easy Set, rectangular, offset drain, 1800 × 900 × 100 mm

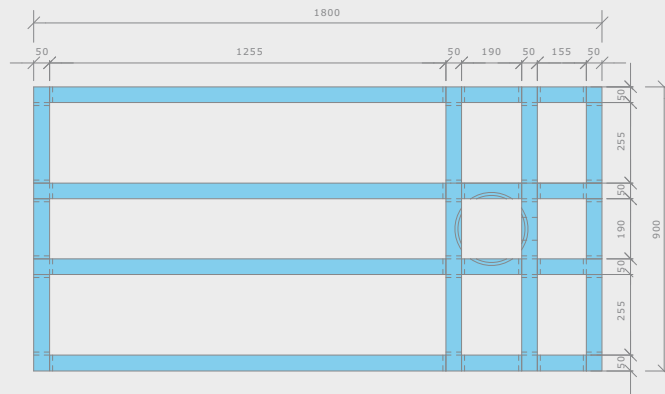

wedi Fundo substrate element ■ special floor element with point drainage

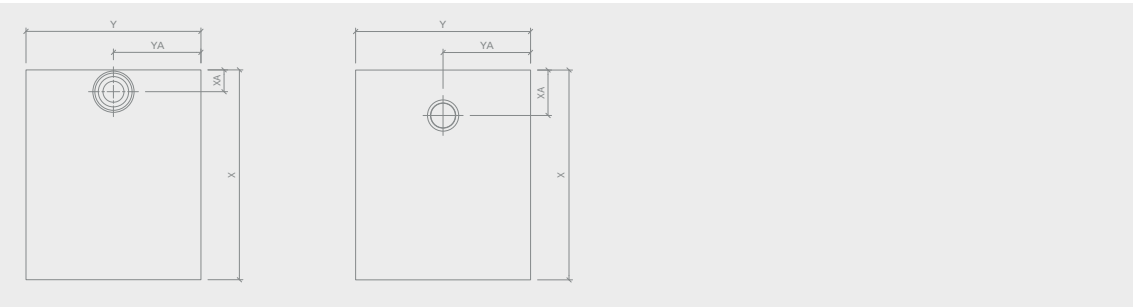
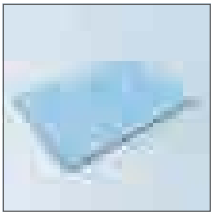

NEW wedi Fundo substrate element Individual ■ special floor element

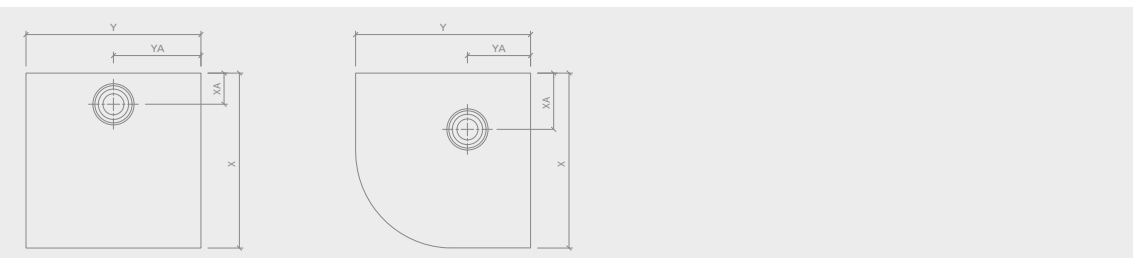
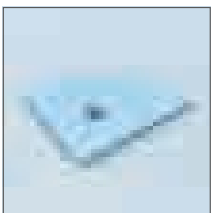

Fundo Ligno ■ floor element



Fundo Ligno, floor element square, central drain, 900 × 900 × 20/41 mm

Top view

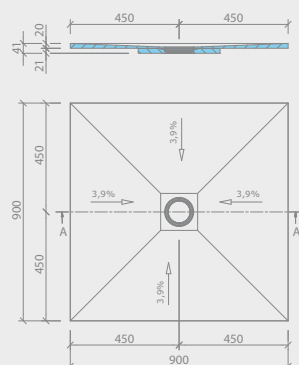

Bottom view

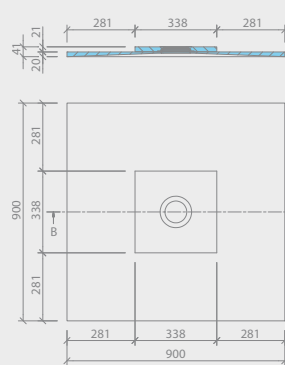

Fundo Ligno ■ floor element

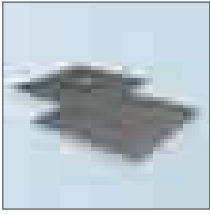

Fundo Ligno, floor element square, central drain, 1200 × 1200 × 20/41 mm

Top view

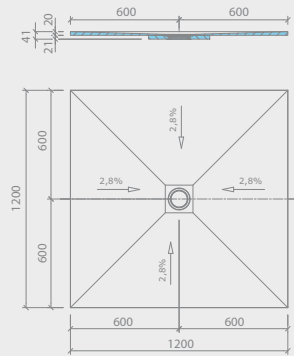

Bottom view

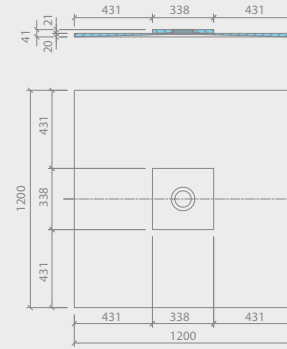

Fundo Ligno, floor element square, central drain, 1500 × 1500 × 20/41 mm

Top view

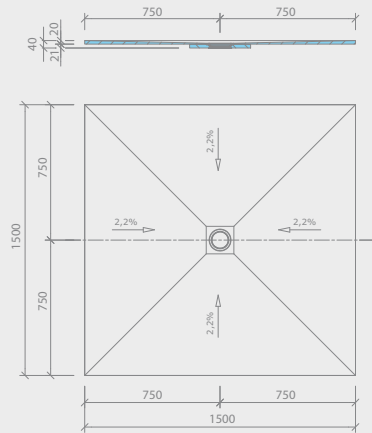

Bottom view

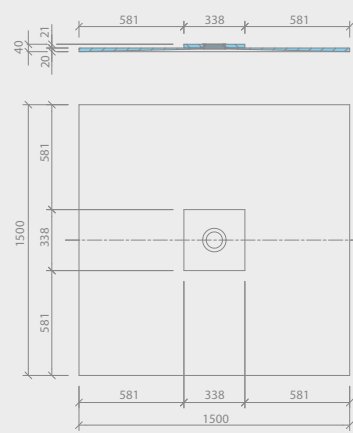

Fundo Ligno, floor element square, corner drain, 900 × 900 × 20/41 mm

Top view

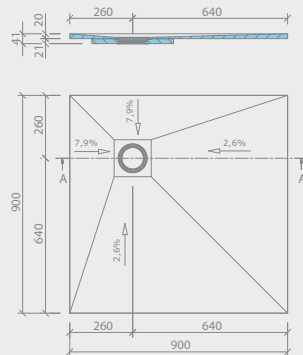

Bottom view

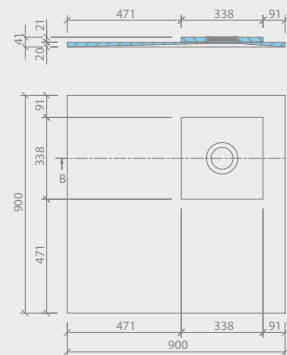

Fundo Ligno ▪ floor element

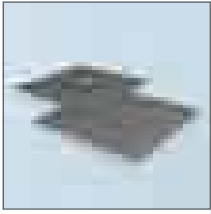

Fundo Ligno, floor element square, corner drain, 1200 x 1200 x 20/41 mm

Top view

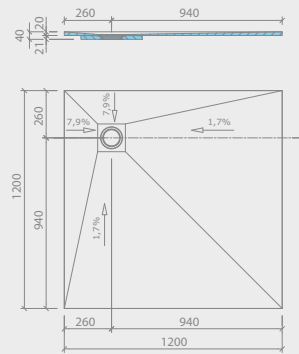

Bottom view

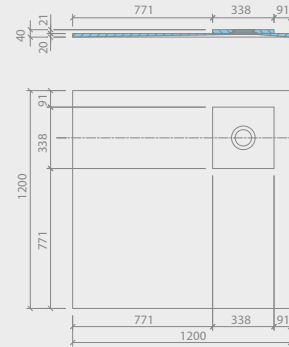

Fundo Ligno, floor element rectangular, offset drain, 1200 x 900 x 20/41 mm

Top view

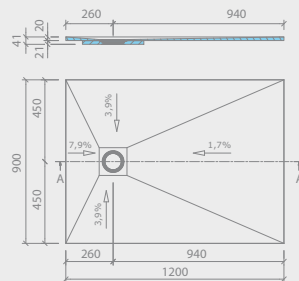

Bottom view

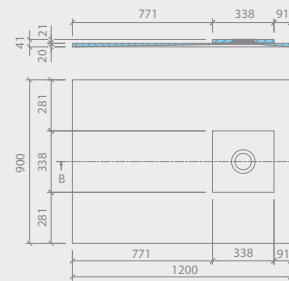

Fundo Ligno, floor element rectangular, offset drain, 1600 x 900 x 20/41 mm

Top view

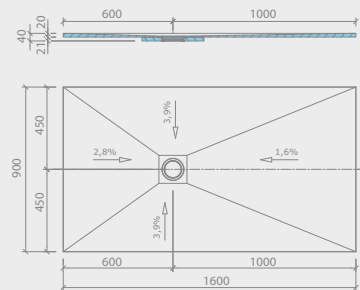

Bottom view

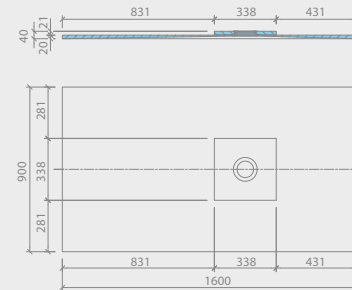

Fundo Ligno Individual ▪ special floor element

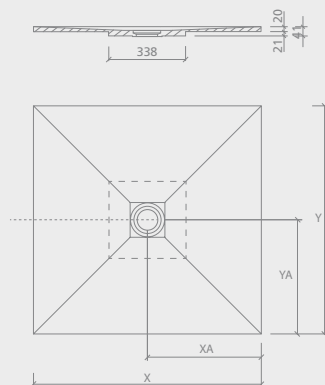

Fundo Riolito ▪ floor element with channel drain



Fundo Riolito, floor element with channel drain, square, 900 × 900 × 50 mm

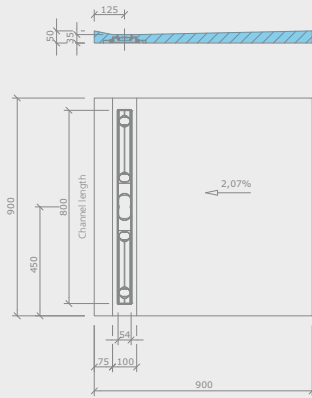

Fundo Riolito, floor element with channel drain, square, 1000 × 1000 × 50 mm

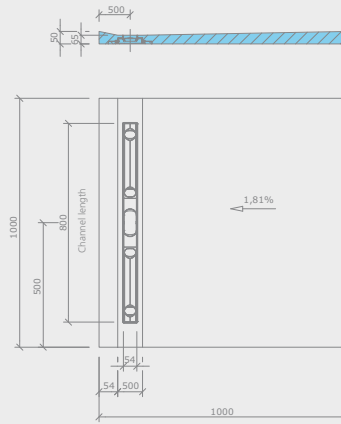

Fundo Riolito, floor element with channel drain, square, 1200 × 1200 × 50 mm

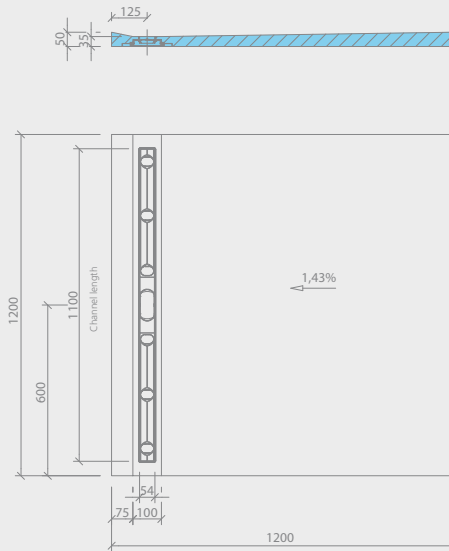

Fundo Riolito, floor element with channel drain, square, short channel, 900 × 900 × 50 mm

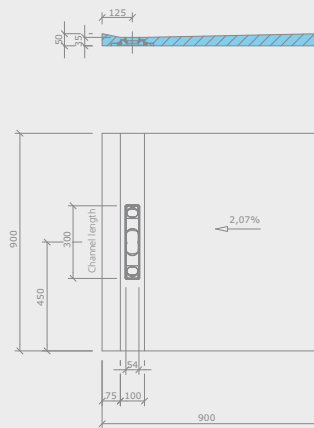

Fundo Riolito, floor element with channel drain, rectangular, 1200 × 800 × 50 mm

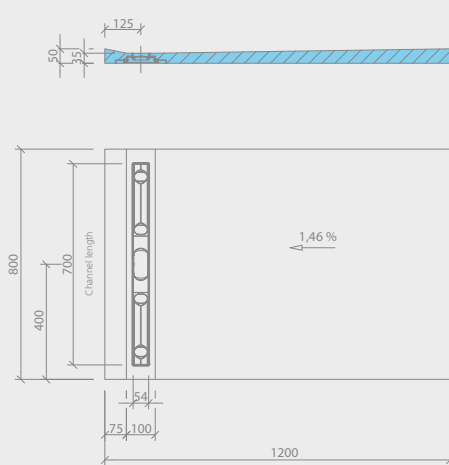

Fundo Riolito, floor element with channel drain, rectangular, 1200 × 900 × 50 mm

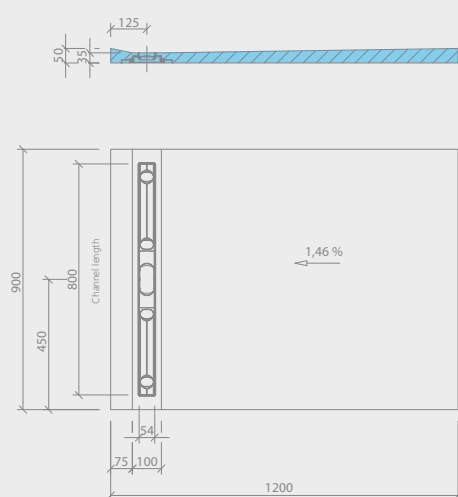

Fundo Riolito ▪ floor element with channel drain



Fundo Riolito, floor element with channel drain, rectangular, 1200 × 1000 × 50 mm

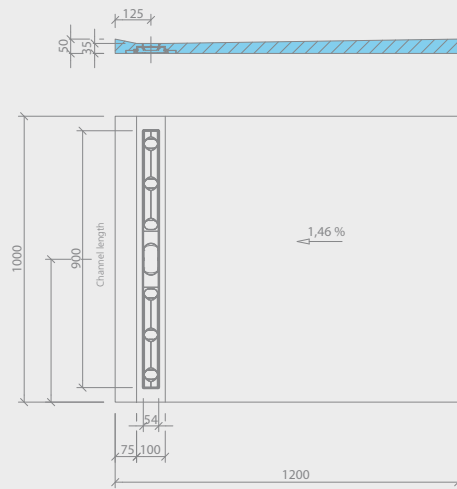

Fundo Riolito, floor element with channel drain, rectangular, 1400 × 900 × 60 mm

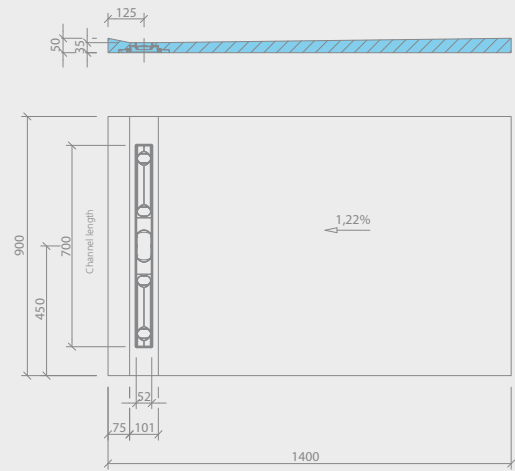

Fundo Riolito, floor element with channel drain, rectangular, 1600 × 1000 × 50 mm

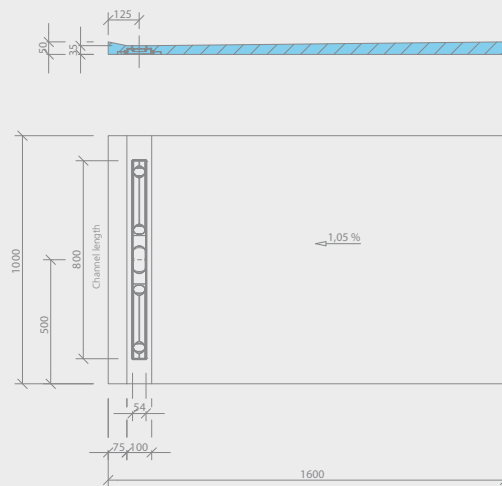

Fundo Riolito, floor element with channel drain, rectangular, 1800 × 900 × 50 mm

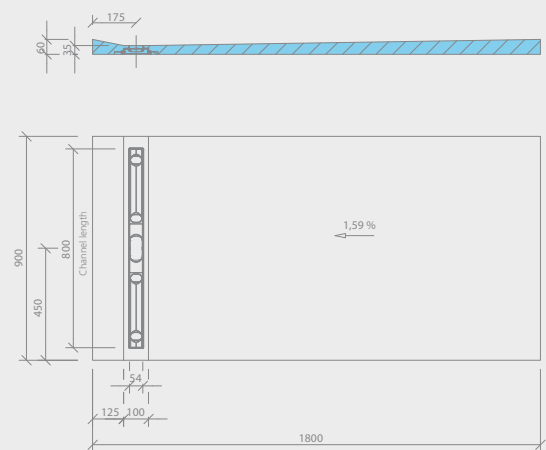

Fundo Riolito ▪ slope wedge, stainless steel V₂A

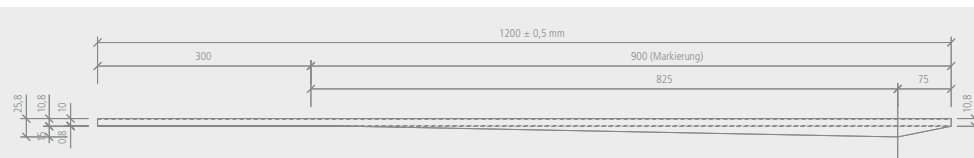

Fundo Riolito ▪ slope profile wall, stainless steel V₂A

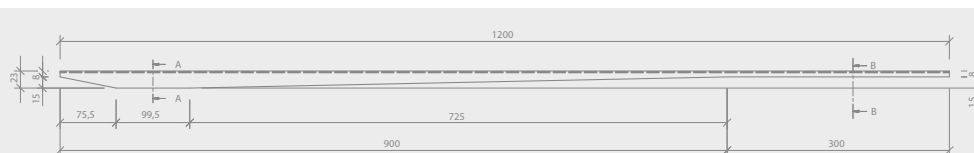

Fundo Riolito neo ▪ floor element with channel drain



Fundo Riolito neo, floor element with channel drain, square, 900 × 900 × 50 mm

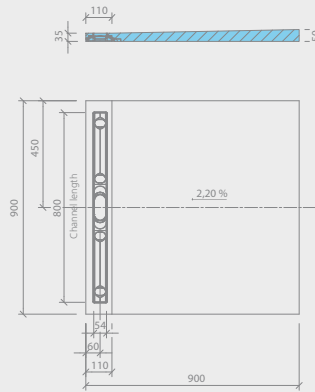

Fundo Riolito neo, floor element with channel drain, square, 1000 × 1000 × 50 mm

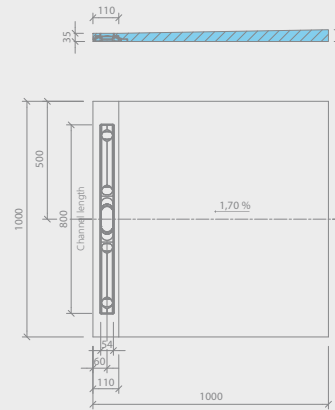

Fundo Riolito neo, floor element with channel drain, square, 1200 × 1200 × 50 mm

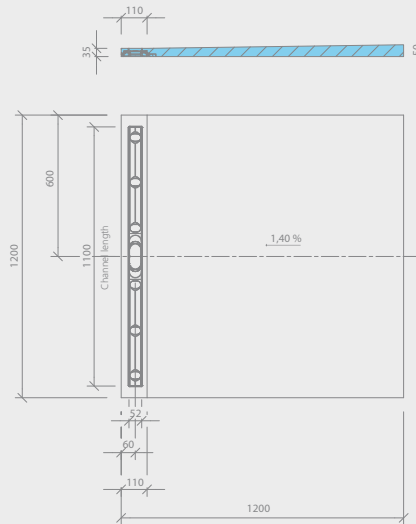

Fundo Riolito neo, floor element with channel drain, short channel, square, 900 × 900 × 50 mm

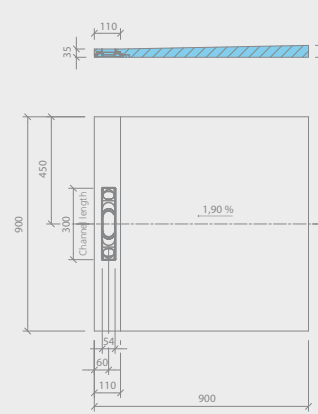

Fundo Riolito neo, floor element with channel drain, rectangular, 1200 × 800 × 50 mm

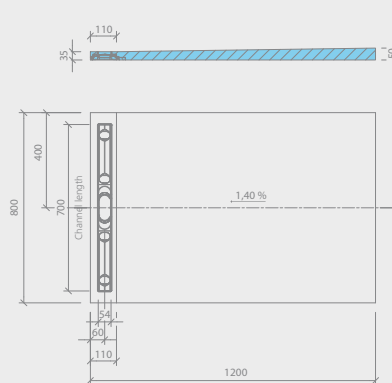

Fundo Riolito neo, floor element with channel drain, rectangular, 1400 × 900 × 50 mm

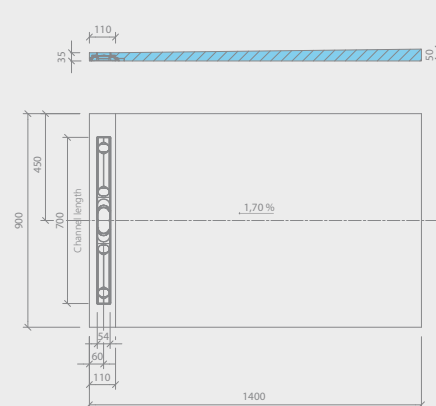

Fundo Riolito neo ▪ floor element with channel drain



Fundo Riolito neo, floor element with channel drain, rectangular, 1200 x 900 x 50 mm

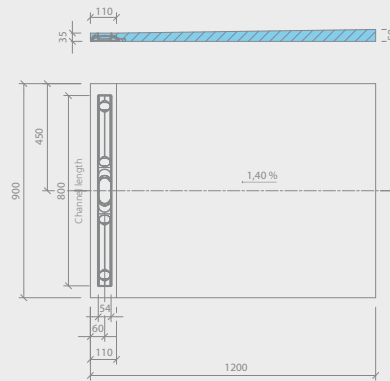

Fundo Riolito neo, floor element with channel drain, rectangular, 1800 x 900 x 60 mm

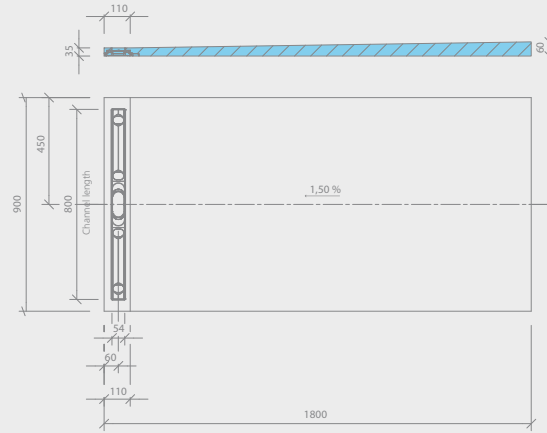

Fundo Riolito neo, floor element with channel drain, rectangular, 1600 x 1000 x 50 mm

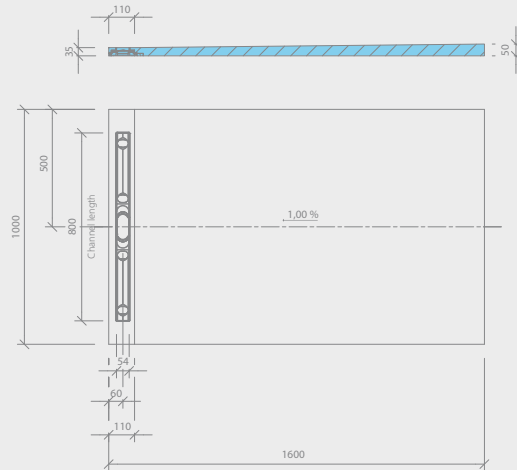

Fundo Riolito neo, floor element with channel drain, rectangular, 1200 x 1000 x 50 mm

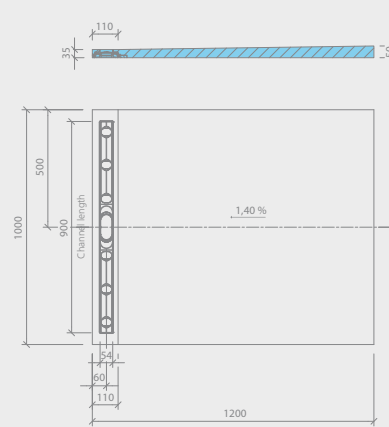

Fundo Riolito neo / Plano Linea slope profile ▪ floor, stainless steel V₂A

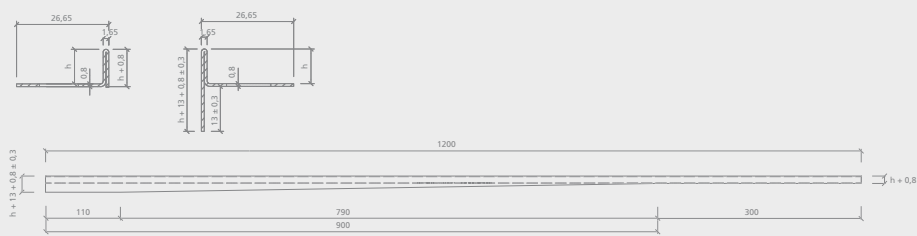

Fundo Riolito neo / Plano Linea slope profile ▪ wall, stainless steel V₂A

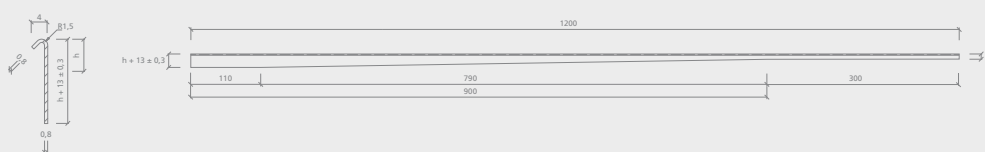

Fundo Riolito neo / Plano Linea end profile

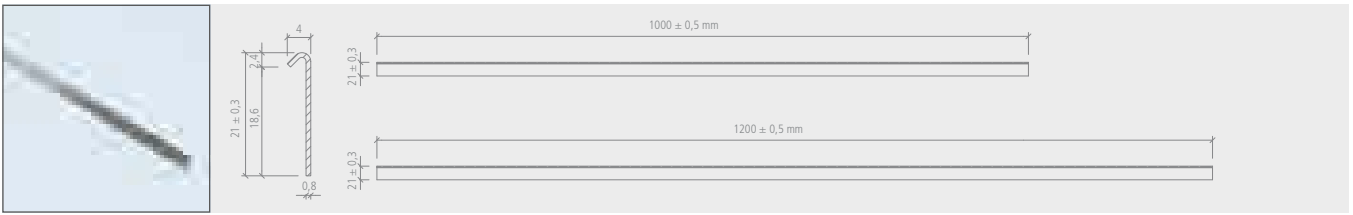

Fundo Riofino ■ floor element with channel drain

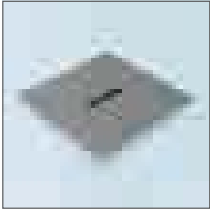

Fundo Riofino, floor element with channel drain, square, 900 × 900 × 50 mm

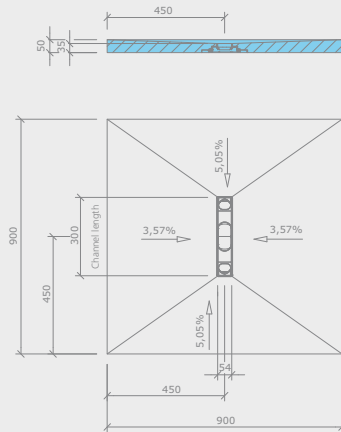

Fundo Riofino, floor element with channel drain, square, 1000 × 1000 × 50 mm

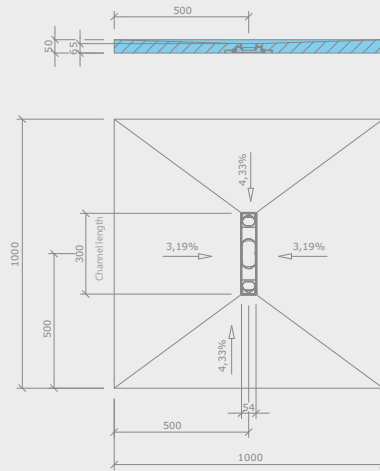

Fundo Riofino, floor element with channel drain, square, 1200 × 1200 × 50 mm

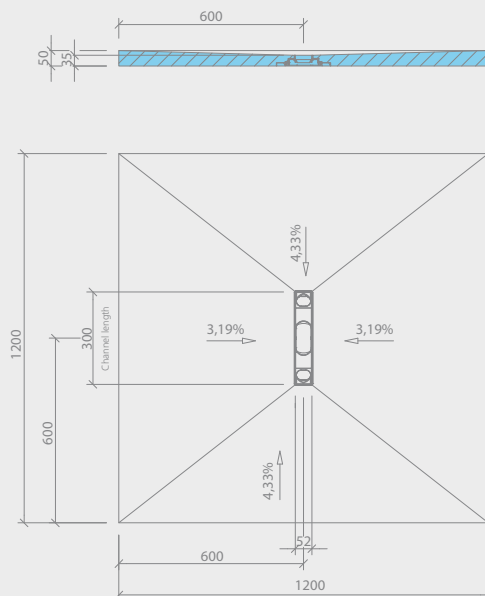

Fundo Riofino, floor element with channel drain, rectangular, 1200 × 900 × 50 mm

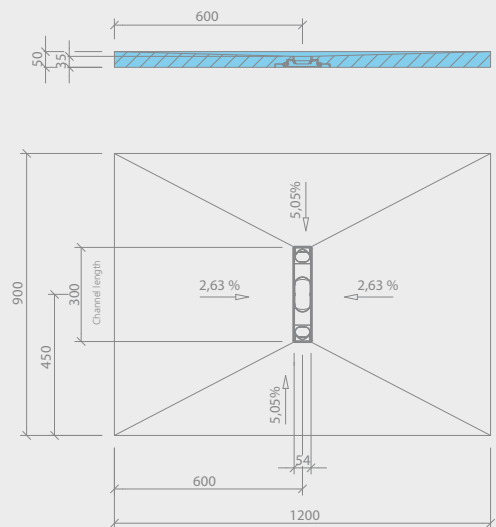

Fundo Riofino ■ floor element with channel drain

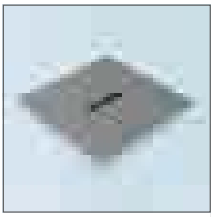

Fundo Riofino, floor element with channel drain, rectangular, 1800 × 900 × 50 mm

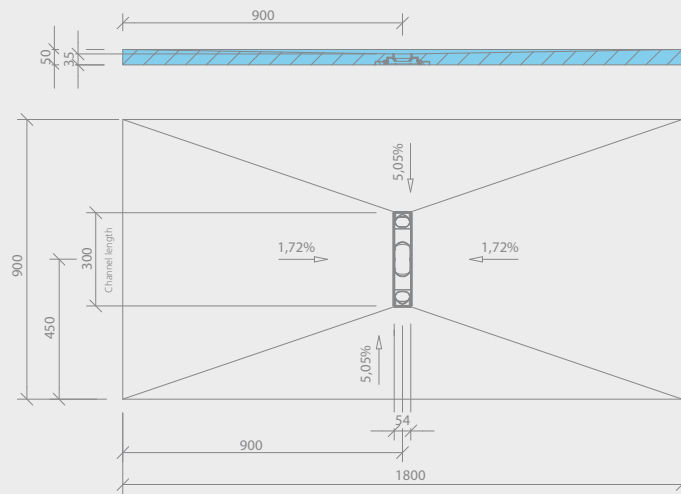

wedi Fundo special floor element ■ with linear drainage

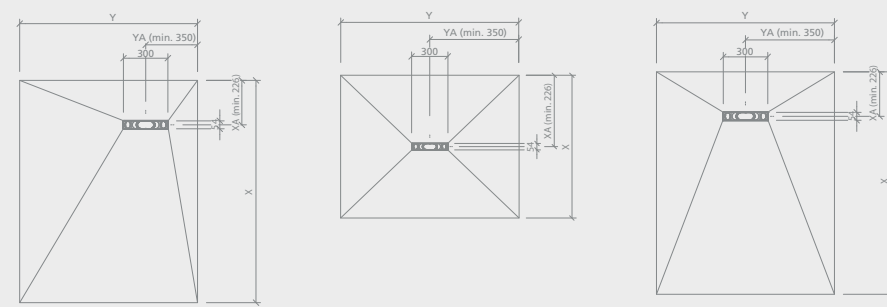

wedi Fundo special floor element ■ with linear drainage

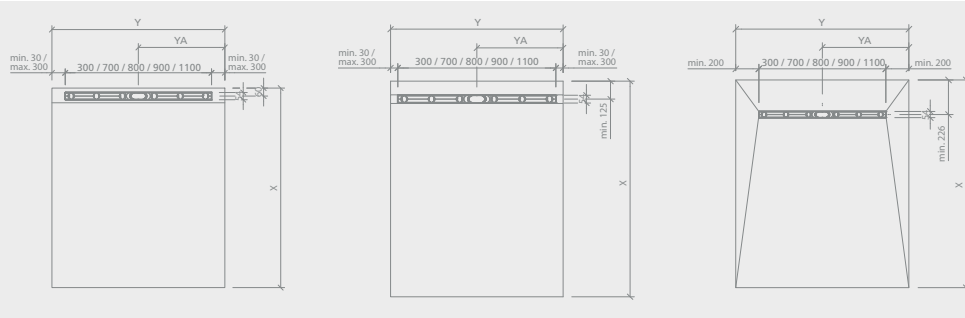

wedi Fundo special floor element ■ with linear drainage

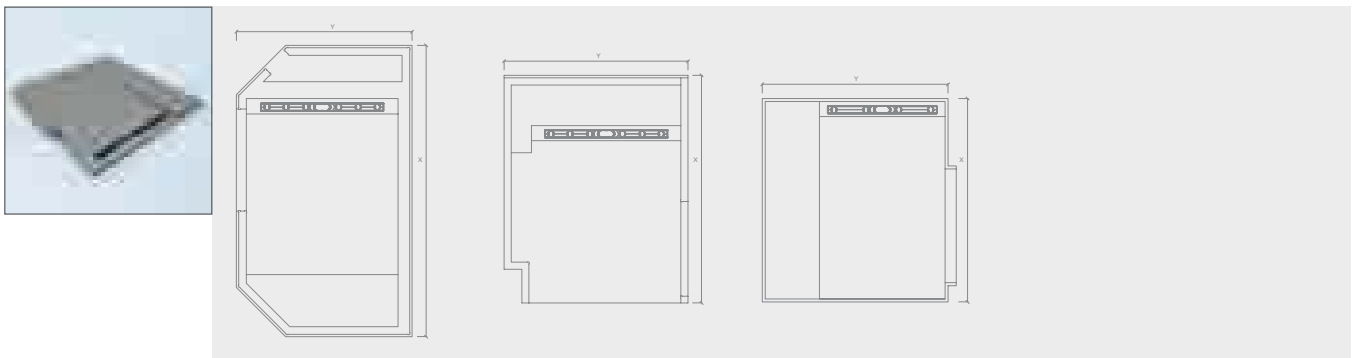

wedi Fundo substrate element ■ special floor element for linear drainage

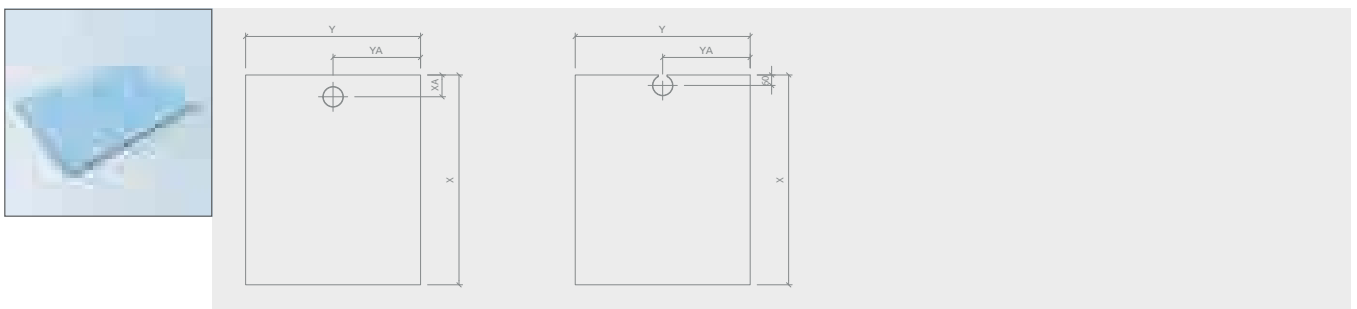

NEW wedi Fundo substrate element Individual ■ special floor element for linear drainage

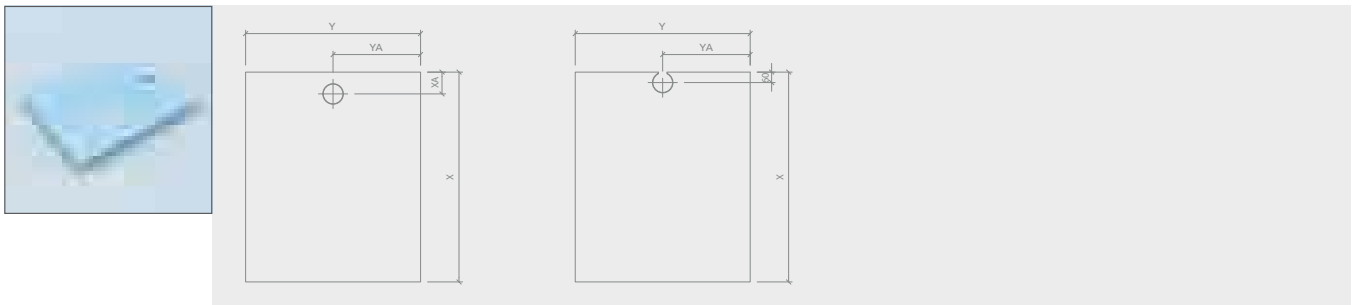

wedi Fundo channel drain ▪ vertical, DN 50

Labels: wedi Fundo sealing set, Tile adhesive, Mortar or cement-bound ballast, Fundo Riolito neo floor element, Connection to the screed

Dimensions: 131, 50

Performance: Absorption capacity: 1,1 Litre/Second
Core drilling diameter: 120 mm

NEW wedi Fundo channel drain ▪ vertical, DN 50 with fire protection collar

Labels: Fundo sealing set, Fundo Riolito floor element, Tile adhesive, Mortar or cement-bound ballast, Connection to the screed, fire protection collar, Mortar MG II or MG III

Dimensions: 131, 98, 54, 50, d = 160 mm

Performance: Absorption capacity: 1.1 Litre/Second
Core drilling diameter: 160 mm

wedi Fundo channel drain ▪ horizontal, DN 50

Labels: wedi Fundo sealing set, Mortar or cement-bound ballast, Fundo Riolito neo floor element, Connection to the screed, Tile adhesive

Dimensions: 130, 60

Performance: Absorption capacity: 0,80 Litre/Second

wedi Fundo channel drain Mini Max ▪ DN 40, extra flat

Labels: wedi Fundo sealing set, Tile adhesive, Mortar or cement-bound ballast, Fundo Riolito neo floor element, Connection to the screed

Dimensions: 99, 60, 40

Performance: Absorption capacity: 0,50 Litre/Second

Fundo Discreto ■ attachment element

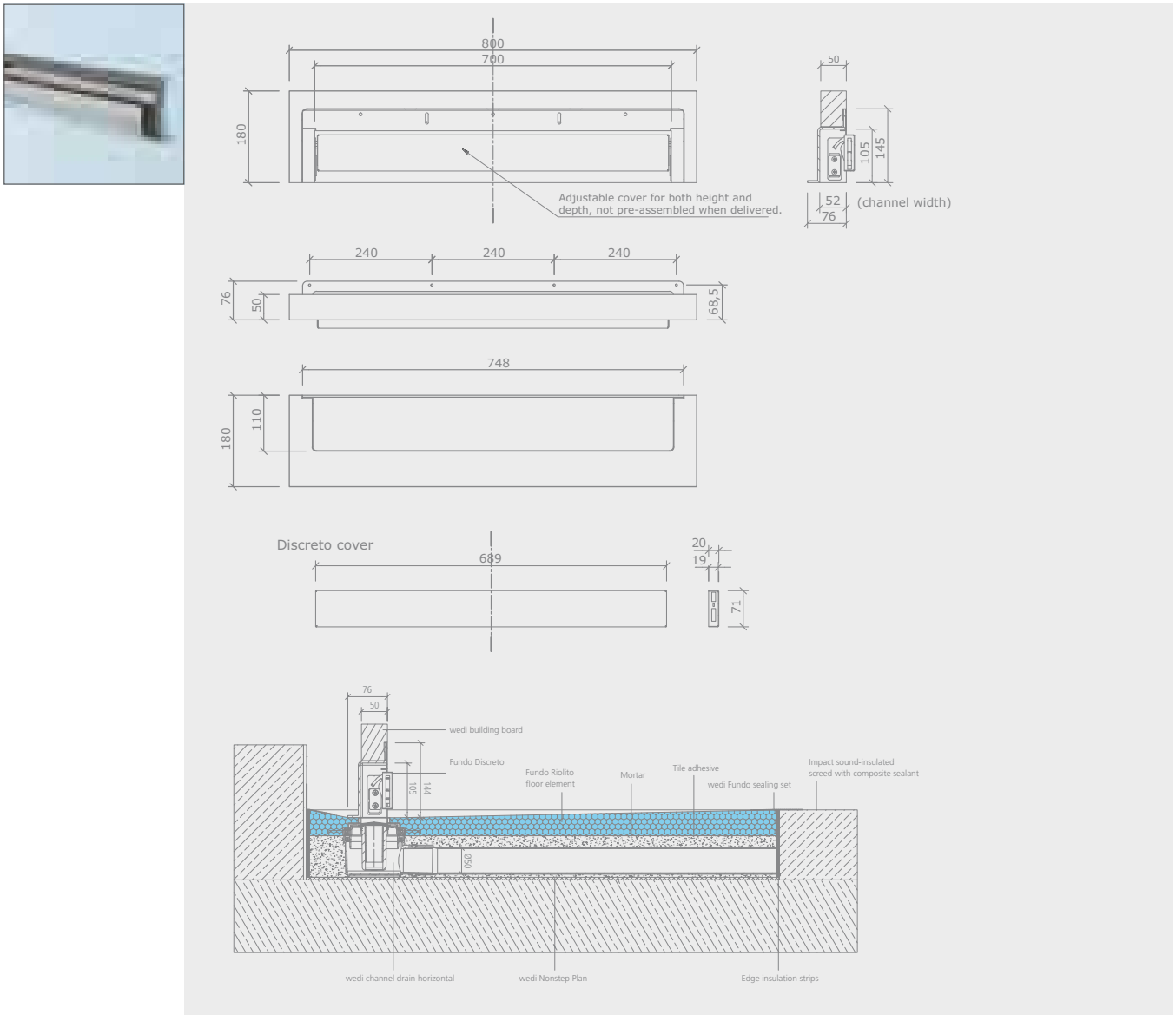

wedi sloping board ■ Riolito neo/Riolito/Riofino

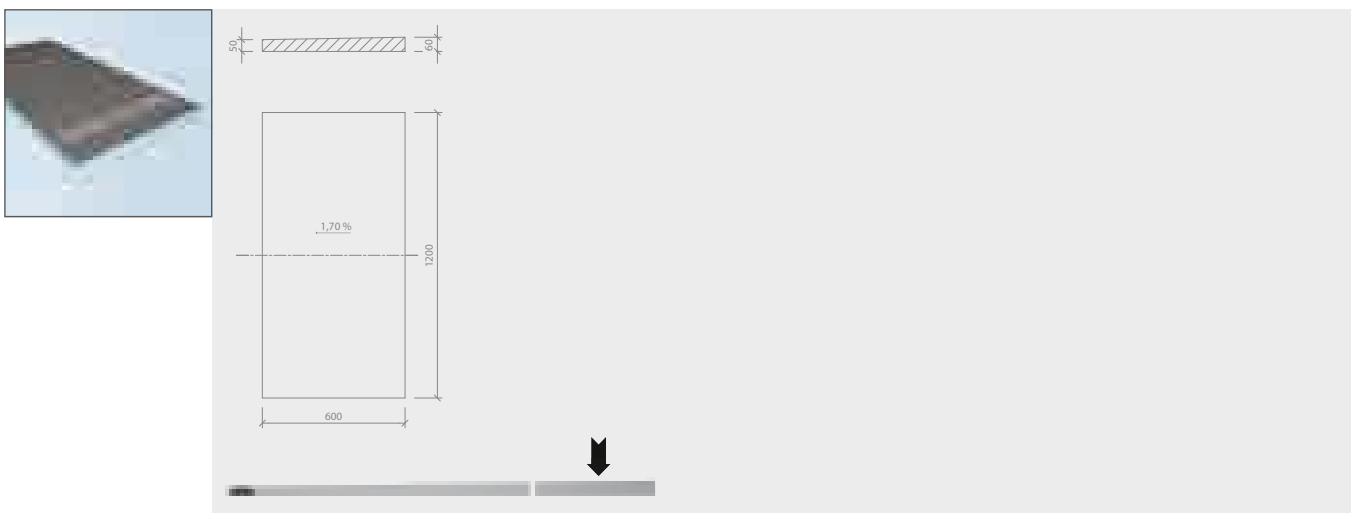

Fundo Integro ■ complete system incl. integrated drain technology

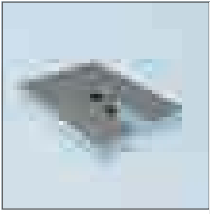

Fundo Integro, central drain, 900 × 900 mm

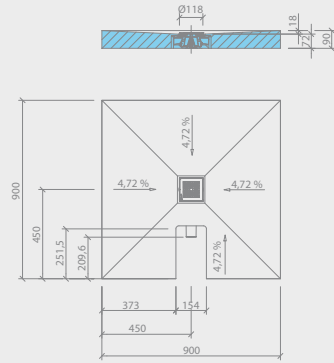

NEW Fundo Integro, central drain, 1000 × 1000 mm

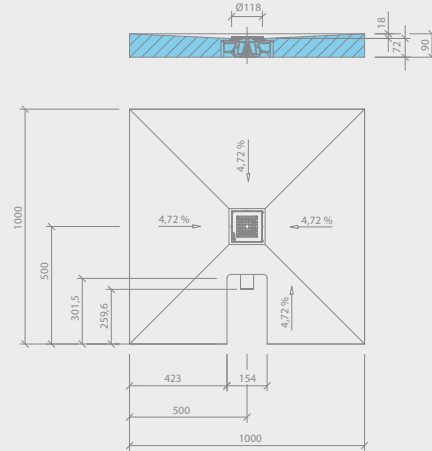

Fundo Integro, central drain, 1200 × 1200 mm

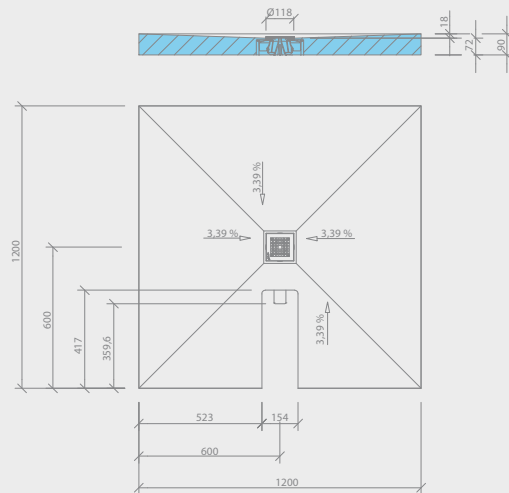

Fundo Integro, central drain, short side connection, 1200 × 900 mm

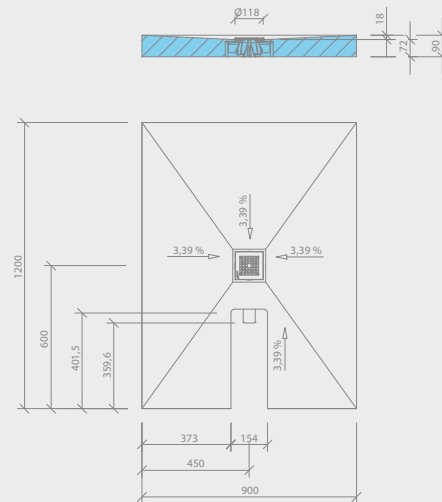

Fundo Integro, central drain, long side connection, 1200 × 900 mm

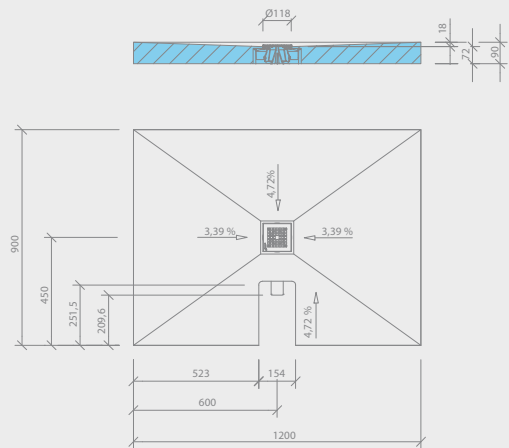

Fundo Integro, offset drain, 1200 × 900 mm

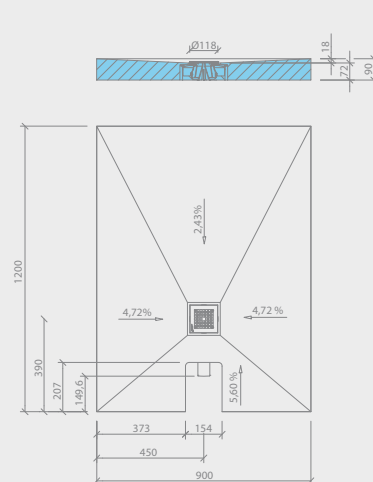

Fundo Integro ■ complete system incl. integrated drain technology



Fundo Integro, offset drain, 1400 × 900 mm

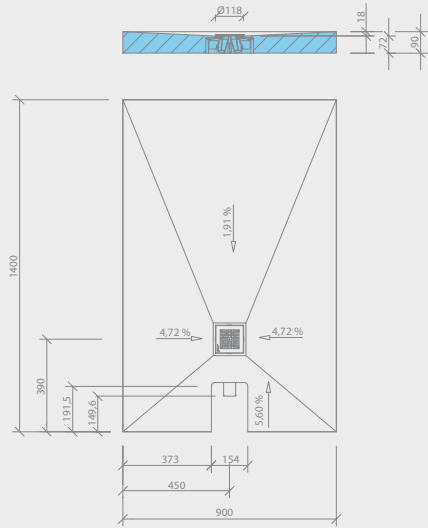

Fundo Integro, offset drain, 1600 × 1000 mm

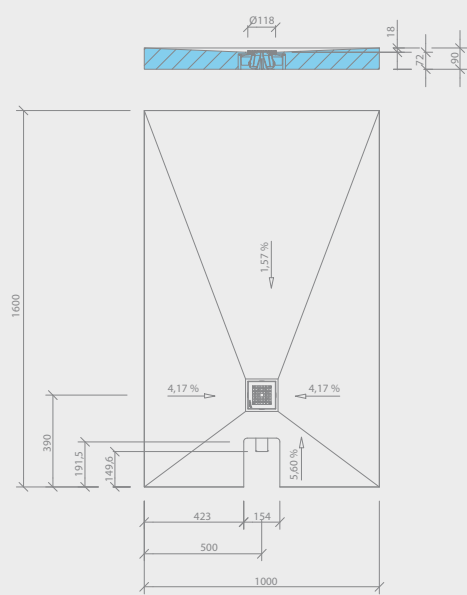

Fundo Integro, offset drain, 1800 × 900 mm

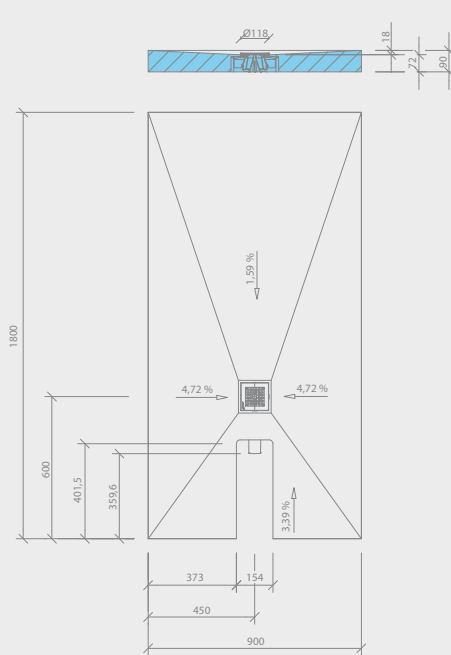

Fundo Plano ■ flat complete system with point drainage



Fundo Plano, central drain,
900 × 900 mm

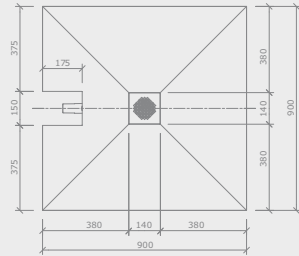
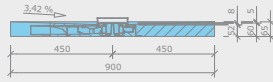

Fundo Plano, central drain,
1000 × 1000 mm

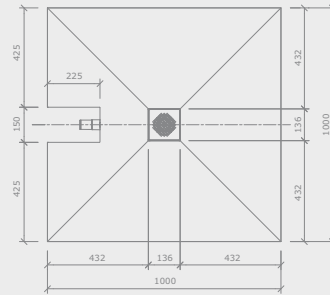

Fundo Plano, central drain,
1200 × 1200 mm

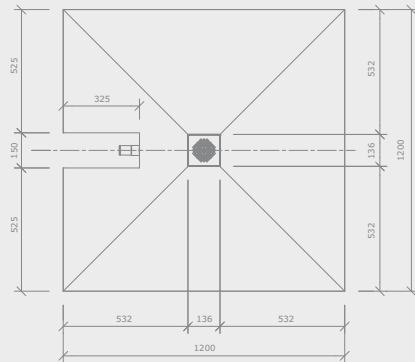
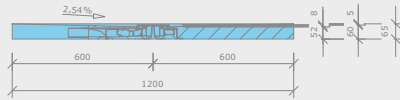

Fundo Plano, central drain,
long side connection, 1200 × 900 mm

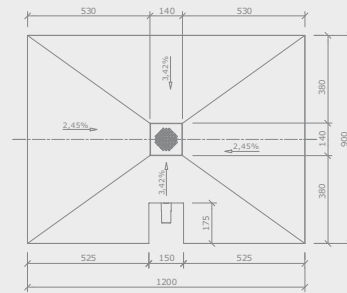
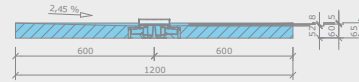

Fundo Plano, central drain,
short side connection, 1200 × 900 mm

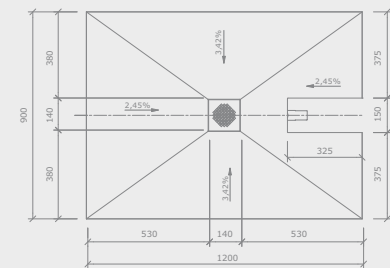
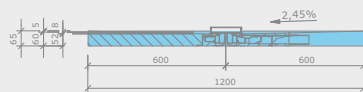

Fundo Plano, non-central drain,
short side connection, 1400 × 900 mm

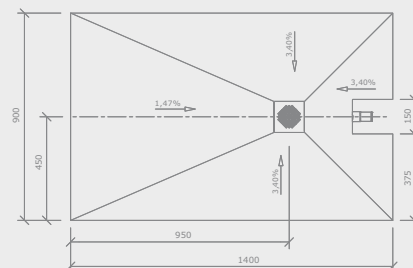

Fundo Plano ■ flat complete system with point drainage



Fundo Plano, non-central drain,
short side connection, 1600 × 1000 mm

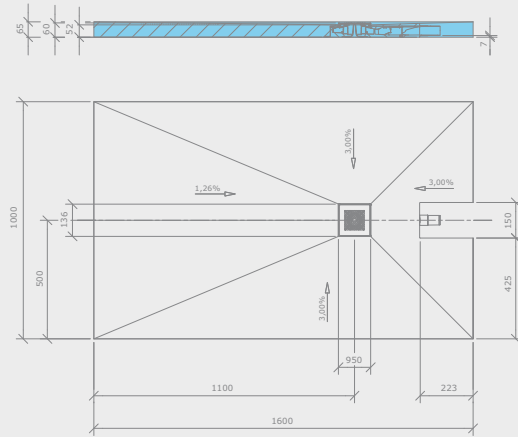

Fundo Plano Linea ■ flat complete system with channel drain

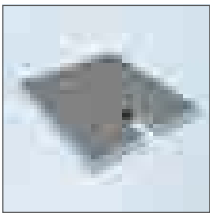

Fundo Plano Linea, rectangular, 1200 × 800 mm

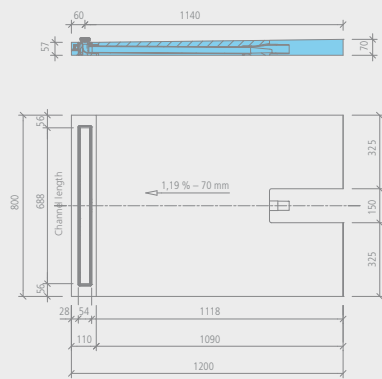

Fundo Plano Linea, rectangular, 1200 × 1000 mm

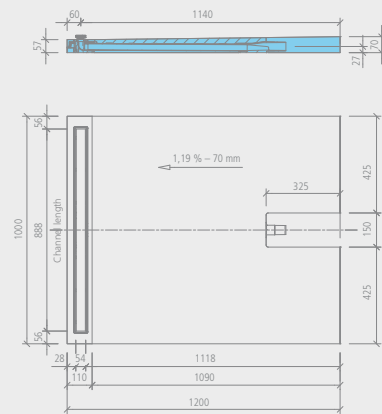

Fundo Plano Linea, rectangular,
1200 × 900 mm

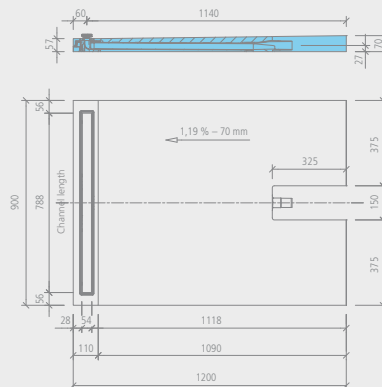

Fundo Plano Linea, rectangular, short channel,
1200 × 900 mm

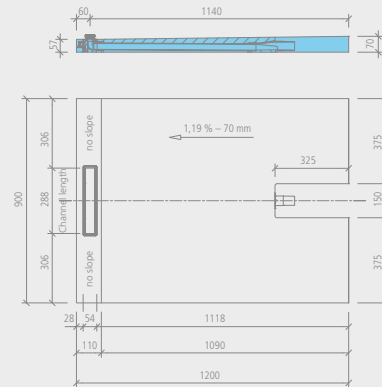

Fundo Plano Linea ■ flat complete system with channel drain

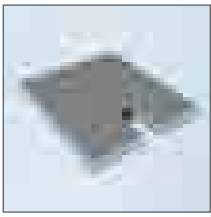

Fundo Plano Linea, square, short channel,
900 × 900 mm

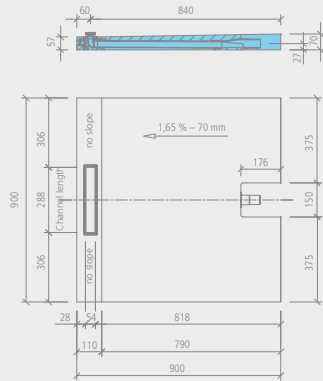

Fundo Plano Linea, square,
900 × 900 mm

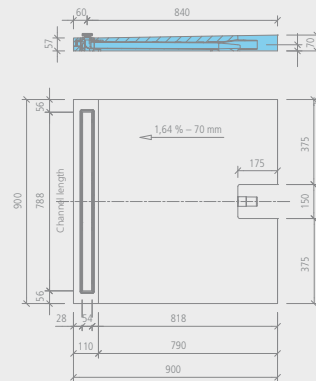

NEW Fundo Integro ■ special floor element

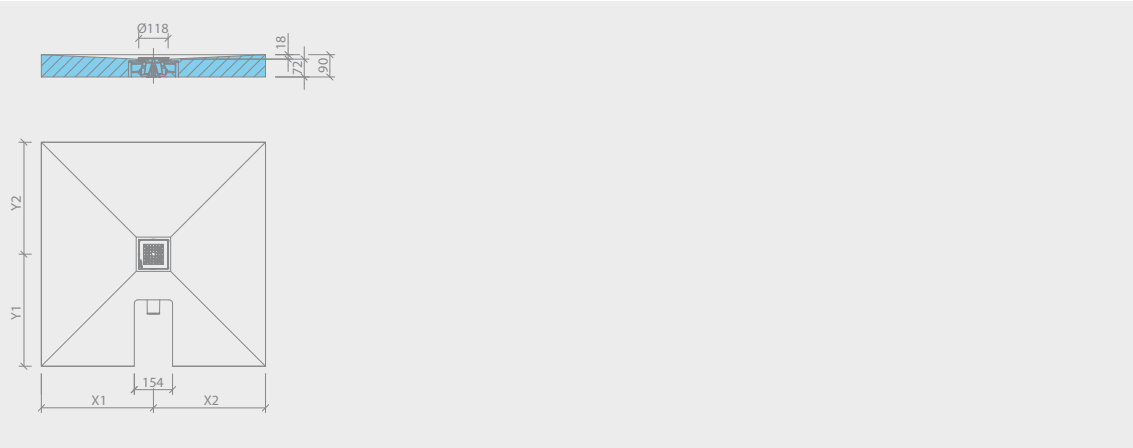

Fundo Plano ■ special floor element

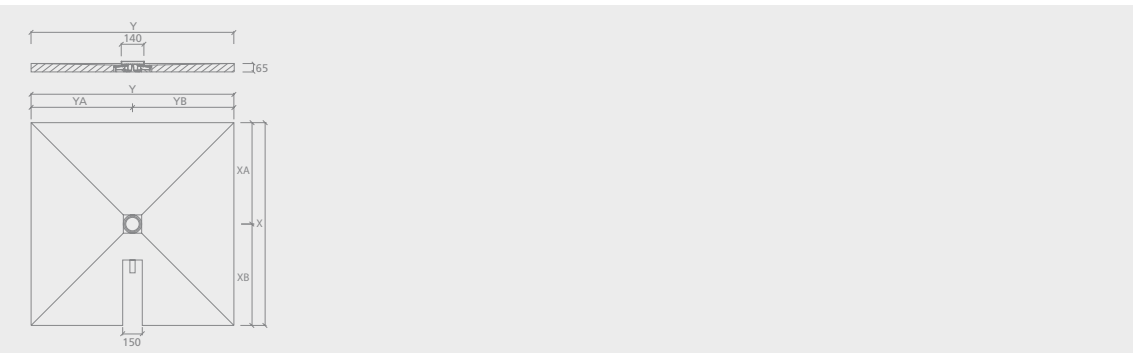

Fundo Plano Linea ■ special floor element

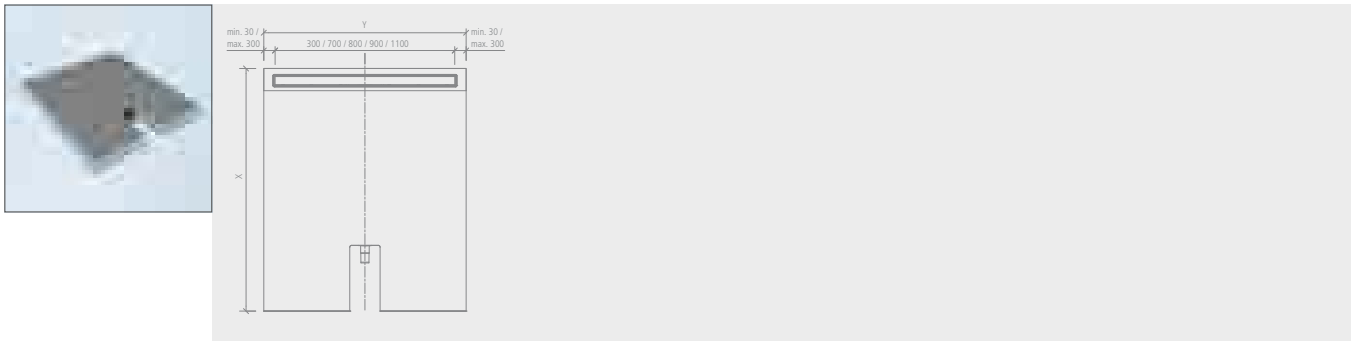

wedi Sanoasa bench 1

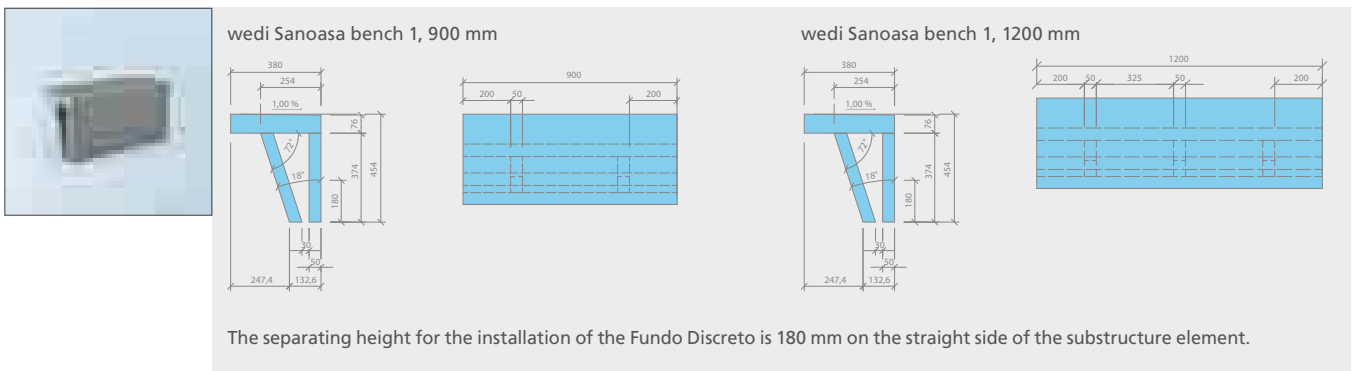

wedi Sanoasa bench 2

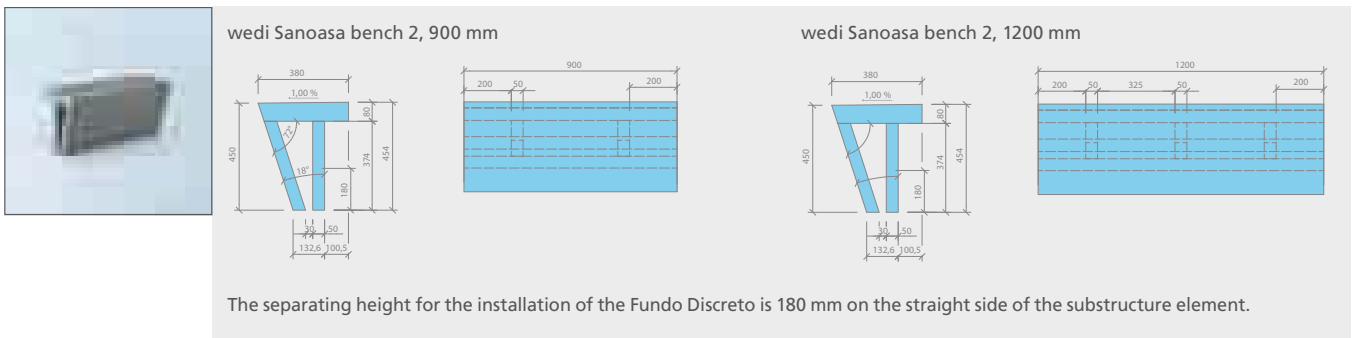

wedi Sanoasa bench 3

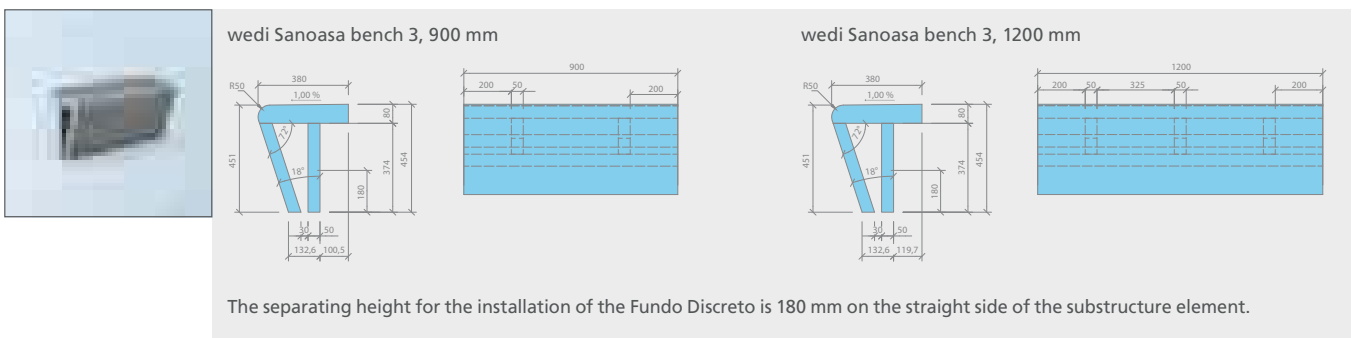

wedi Sanoasa bench 4

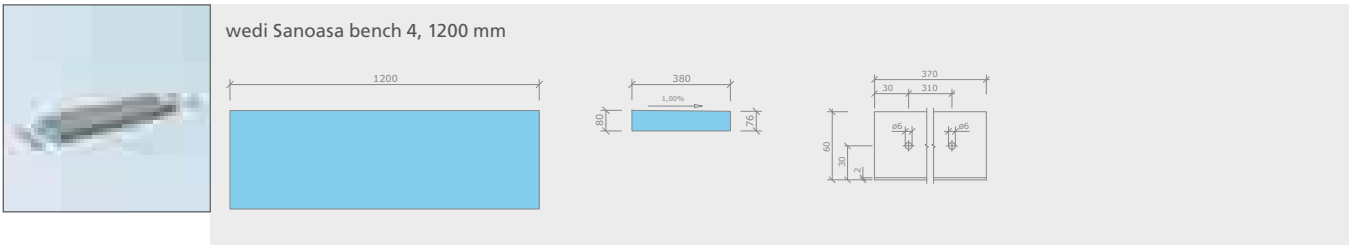

wedi Sanoasa corner seat element

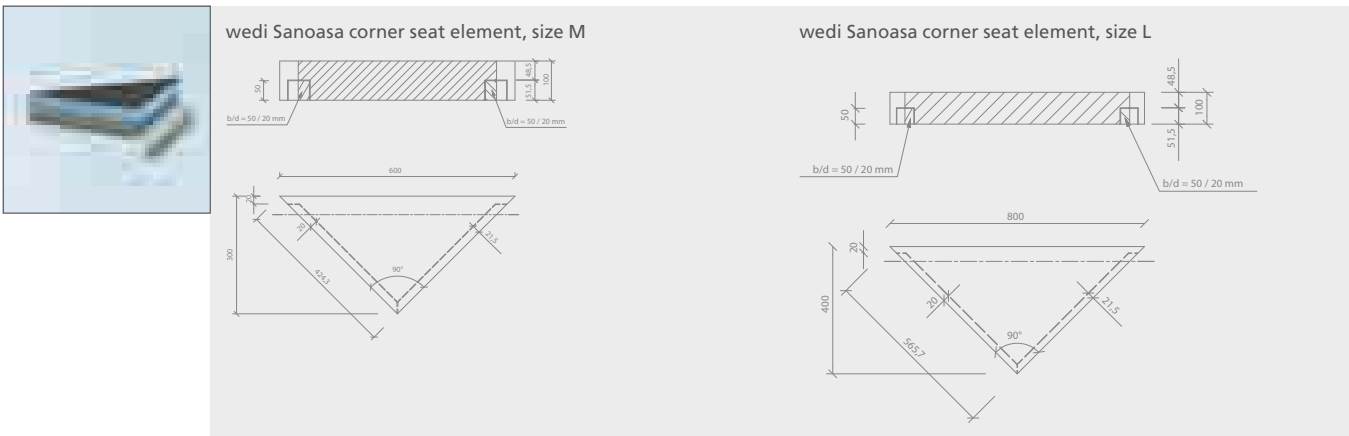

NEW wedi Sanwell wall element ■ Partition wall with niche

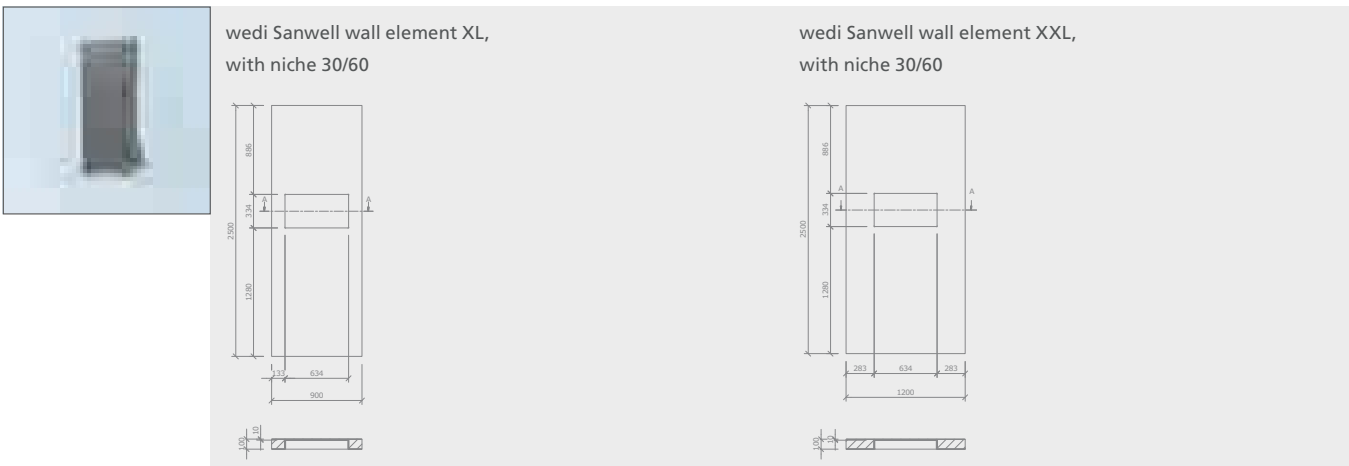

wedi Sanwell Niche, rectangular

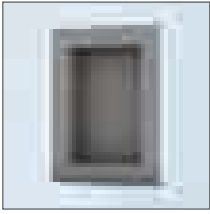

wedi Sanwell Niche, 20/40. Frame width 10.0 mm

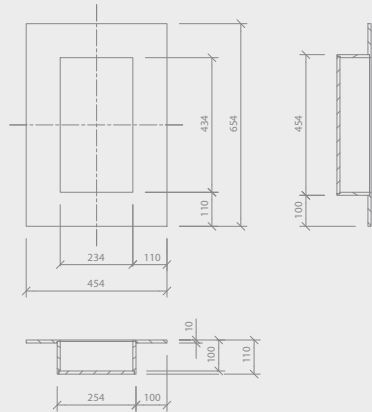

wedi Sanwell Niche, 30/60. Frame width 10.0 mm

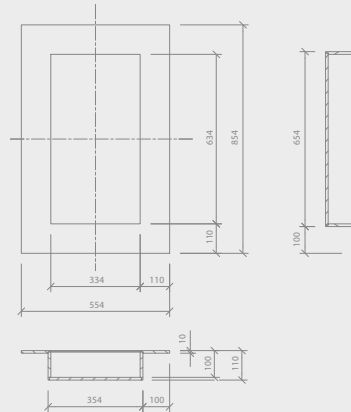

wedi Sanwell Niche, 20/40. Frame width 12.5 mm

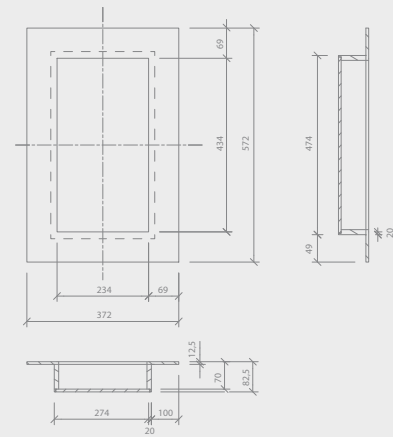

wedi Sanwell Niche, 30/60. Frame width 12.5 mm

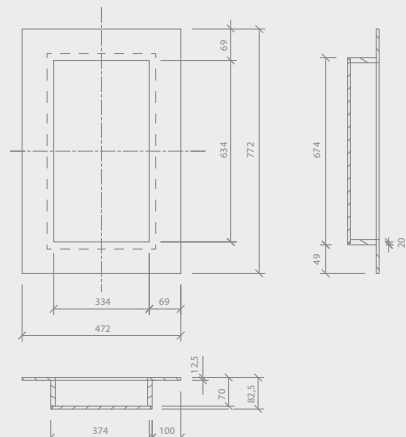

wedi Sanoasa Comoda ▪ bench / carrier element



wedi Sanoasa Comoda, slope to front,
carrier element, round finish length

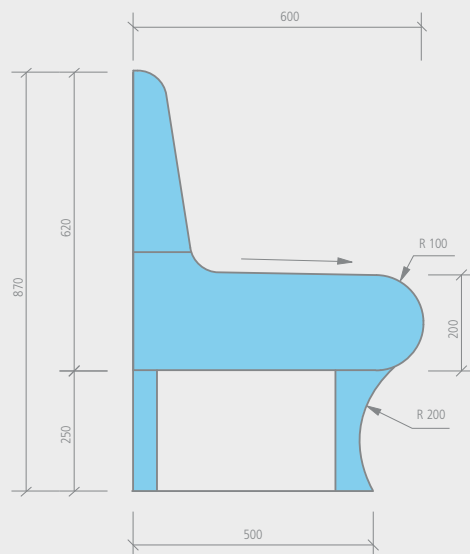

wedi Sanoasa Comoda ▪ bench / carrier element



wedi Sanoasa Comoda, slope to front,
carrier element, straight finish length

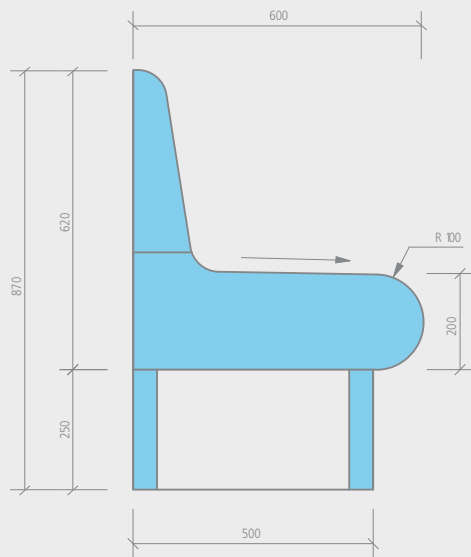

wedi Sanoasa Comoda ▪ corner element 90°

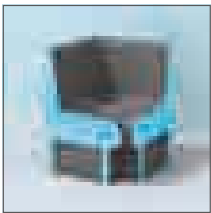

wedi Sanoasa Comoda, bench corner element 90°,
straight, slope to front

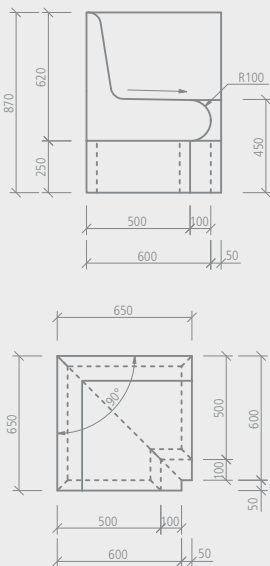

wedi Sanoasa Comoda, bench corner element 90°,
round, slope to front

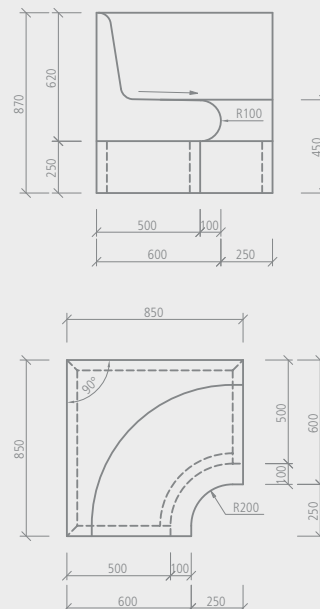

wedi Sanoasa Comoda ▪ corner element 135°



wedi Sanoasa Comoda, bench corner element 135°, straight, slope to front

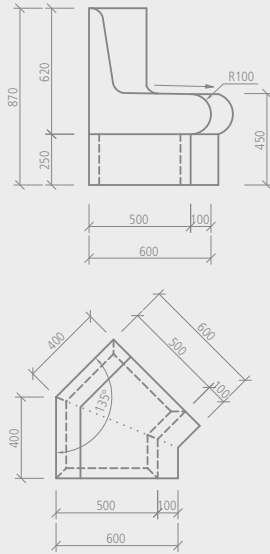

wedi Sanoasa Comoda, bench corner element 135°, round, slope to front

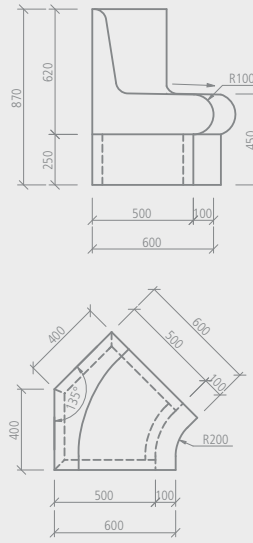

wedi Sanoasa Comoda ▪ end element left



wedi Sanoasa Comoda, end element left, R = 200, slope to front

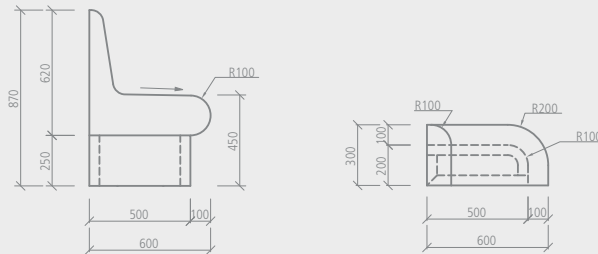

wedi Sanoasa Comoda, end element left, R = 600, slope to front

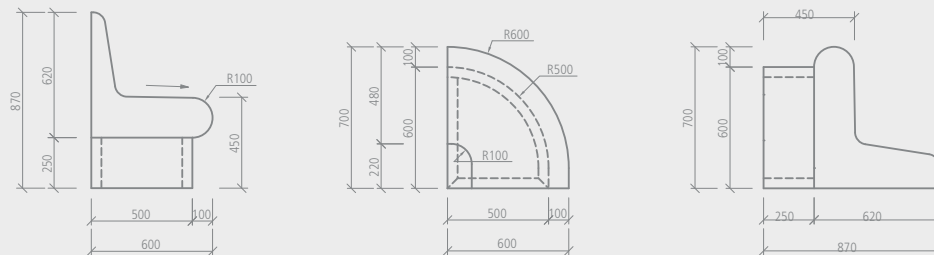

wedi Sanoasa Comoda ▪ end element right



wedi Sanoasa Comoda, end element right,
R = 200, slope to front

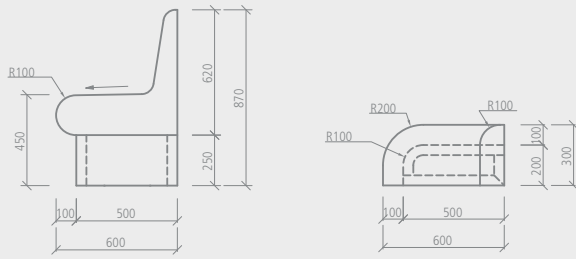

wedi Sanoasa Comoda, end element right,
R = 600, slope to front

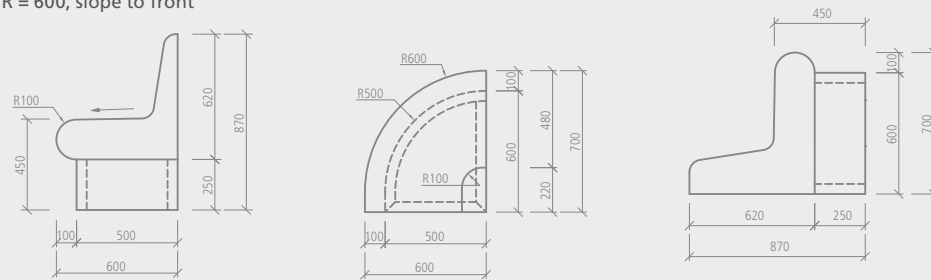

wedi Sanoasa Comoda ▪ armrest

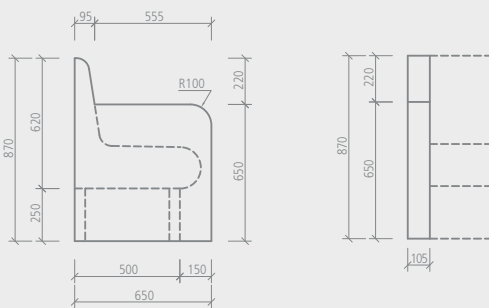
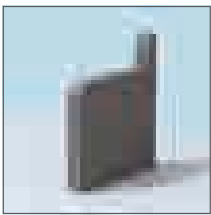

wedi Sanoasa Bellina ▪ bench / carrier element



wedi Sanoasa Bellina, slope to front,
carrier element, round finish length

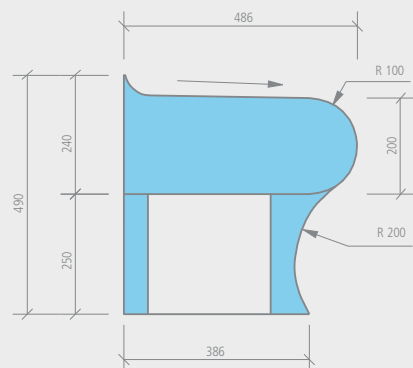

wedi Sanoasa Bellina, slope to front,
carrier element, straight finish length

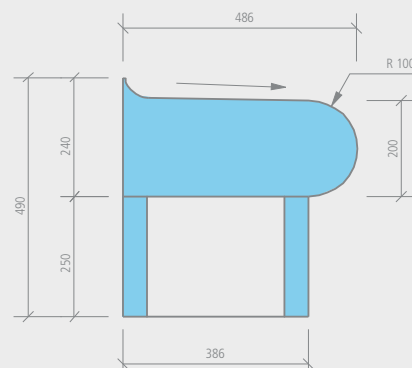

wedi Sanoasa Bellina ▪ corner element 90°



wedi Sanoasa Bellina, bench corner element 90°, straight, slope to front

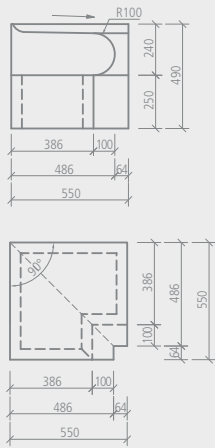

wedi Sanoasa Bellina, bench corner element 90°, round, slope to front

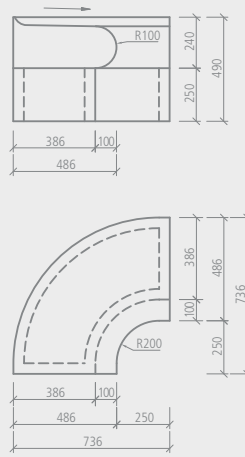

wedi Sanoasa Bellina ▪ corner element 135°



wedi Sanoasa Bellina, bench corner element 135°, straight, slope to front

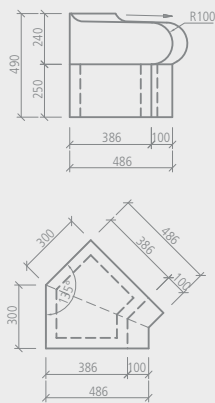

wedi Sanoasa Bellina, bench corner element 135°, round, slope to front

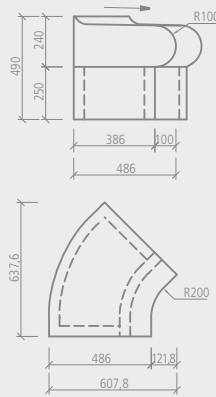

wedi Sanoasa Bellina ▪ end element left

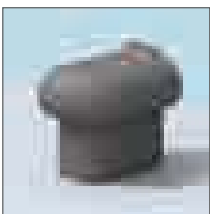

wedi Sanoasa Bellina, end element left, R = 200, slope to front

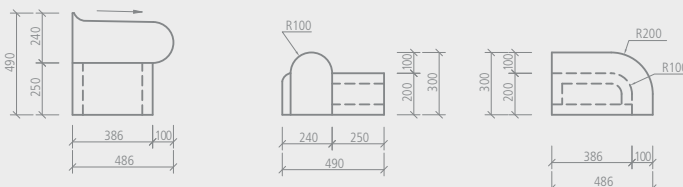

wedi Sanoasa Bellina, end element left, R = 486, slope to front

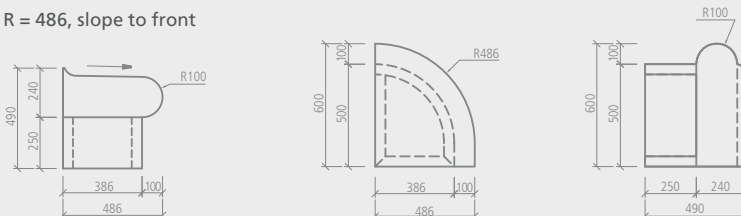

wedi Sanoasa Bellina ▪ end element right



wedi Sanoasa Bellina, end element right,
R = 200, slope to front

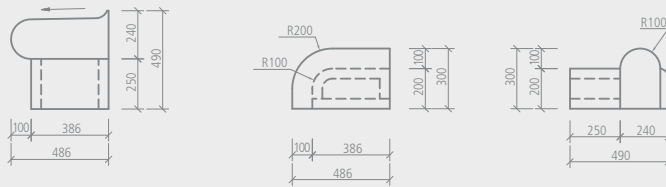

wedi Sanoasa Bellina, end element right,
R = 486, slope to front

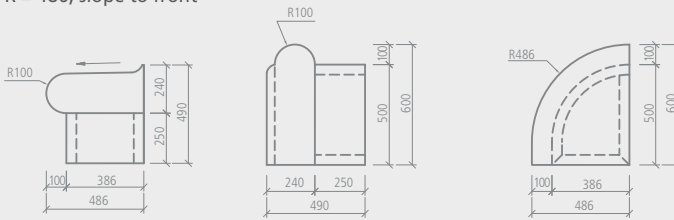

wedi Sanoasa Bellina ▪ armrest

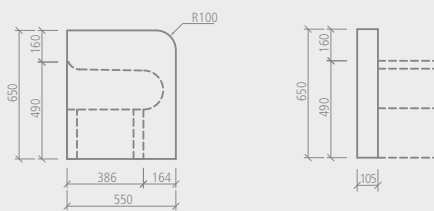
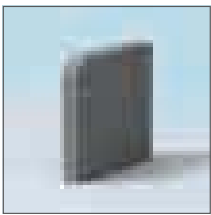

wedi Sanoasa Lounger 1 ▪ Lounger

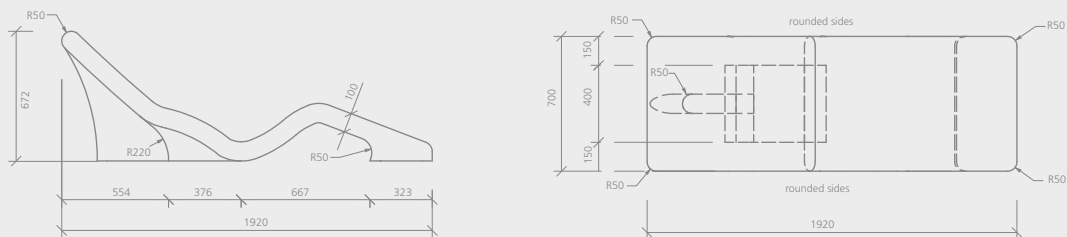

wedi Sanoasa Lounger 2 ■ Lounger

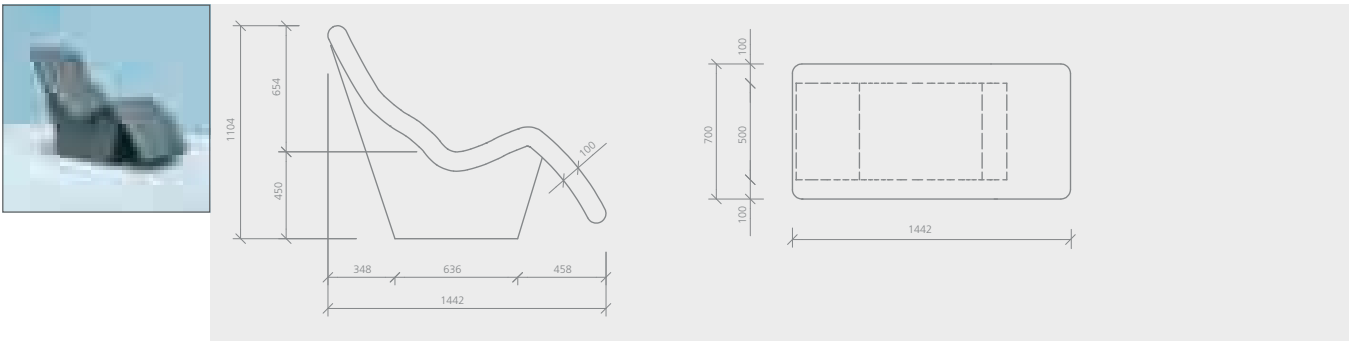

wedi Sanoasa Lounger 3 ■ Lounger

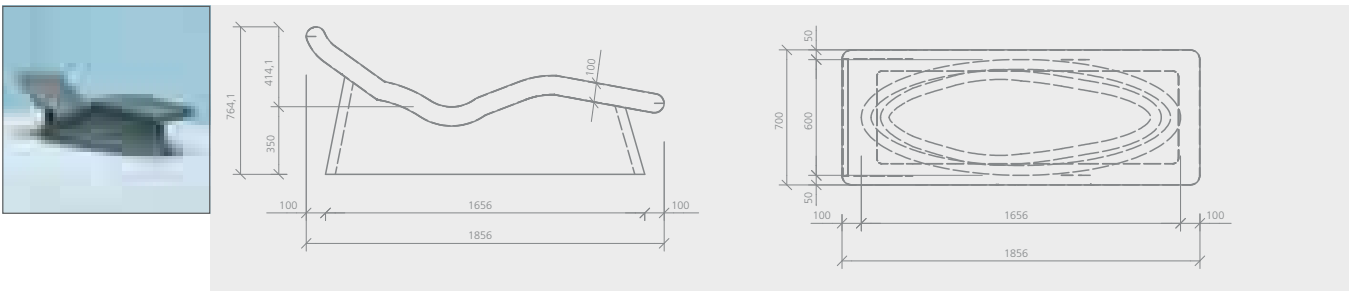

wedi Sanoasa Lounger 4 ■ Lounger

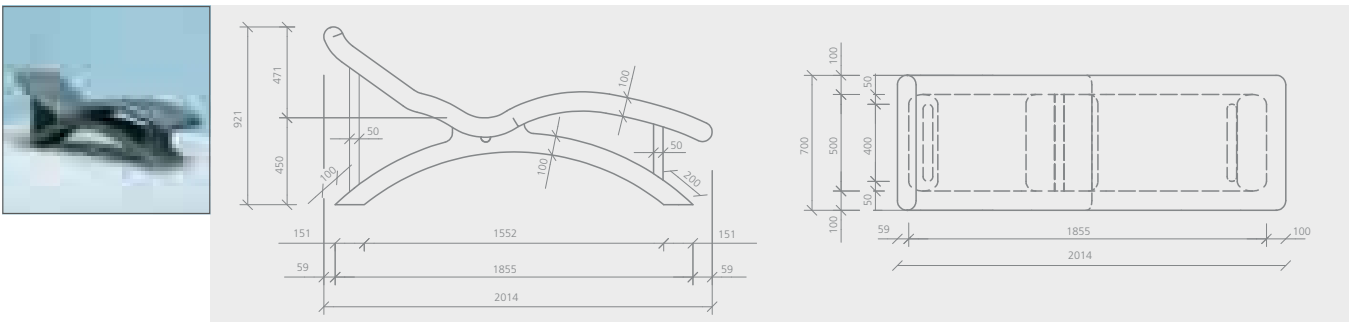

wedi Sanoasa Lounger 5 ■ Lounger

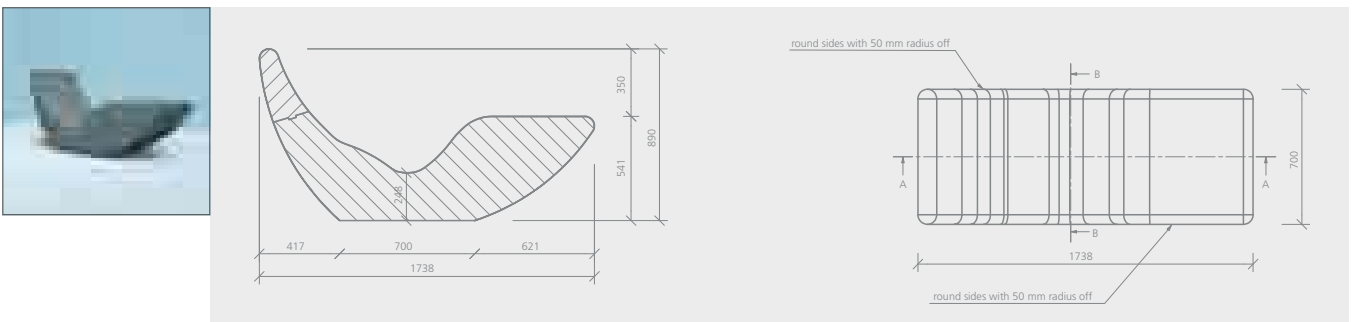

wedi Sanbath Cube ■ tub

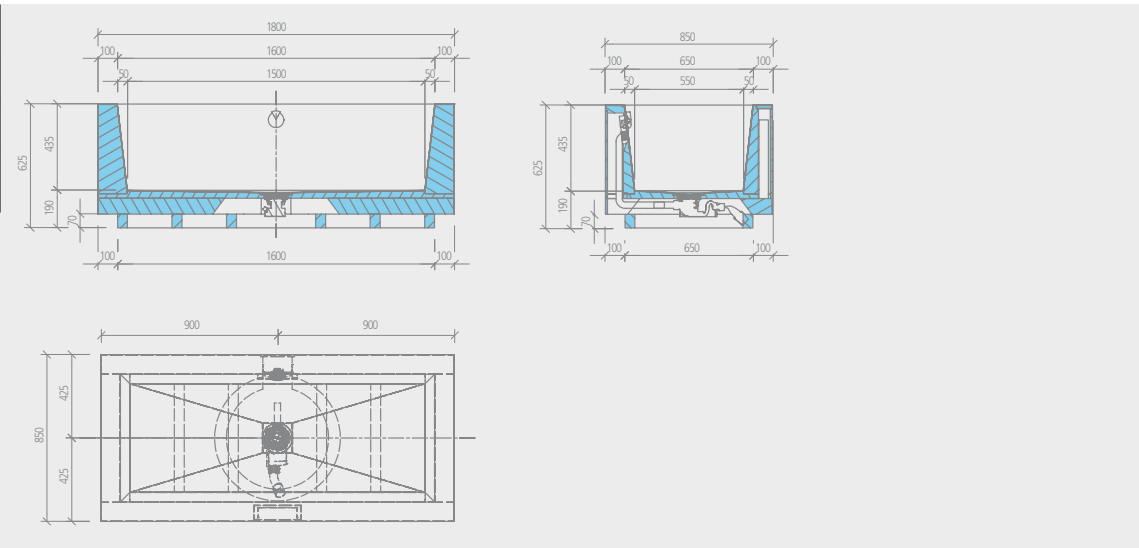

wedi Sanbath Cube ■ tub

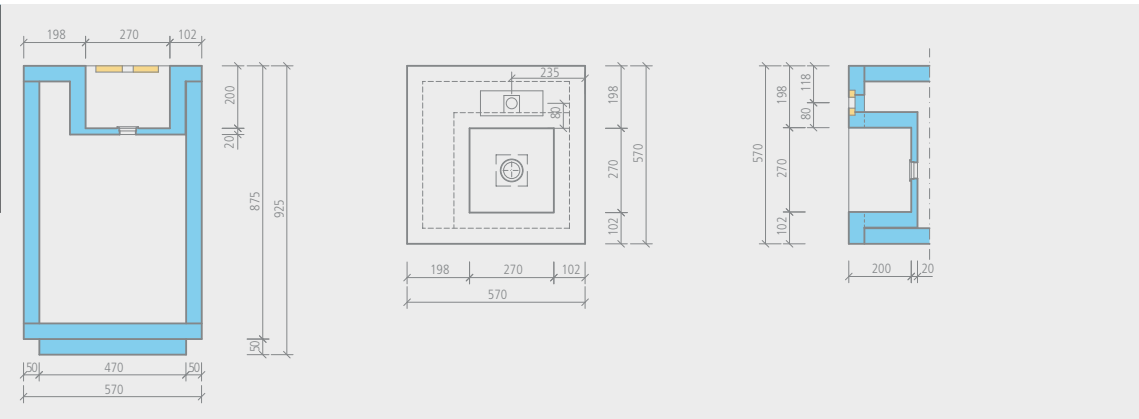

wedi Sanbath Cube ■ shower unit

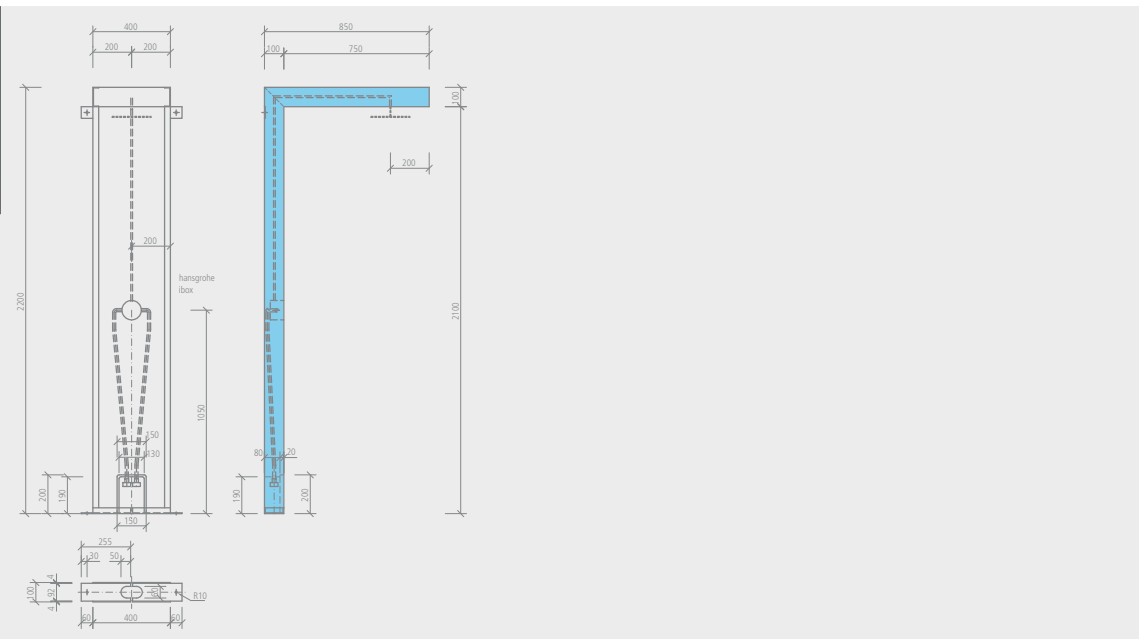

wedi Sanbath Wave ■ tub

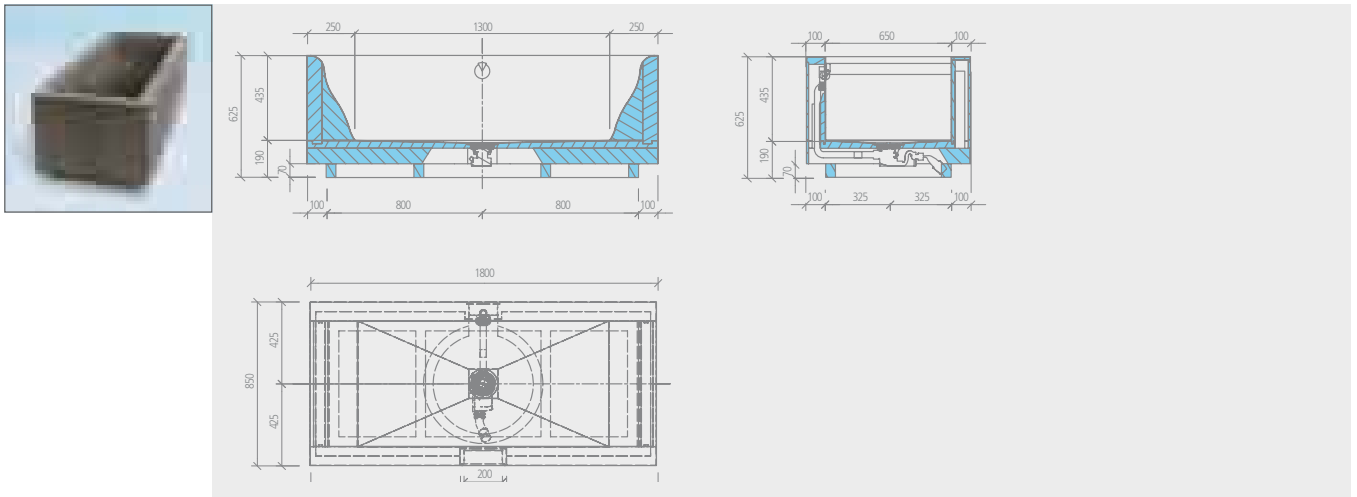

wedi Sanbath Wave ■ wash basin

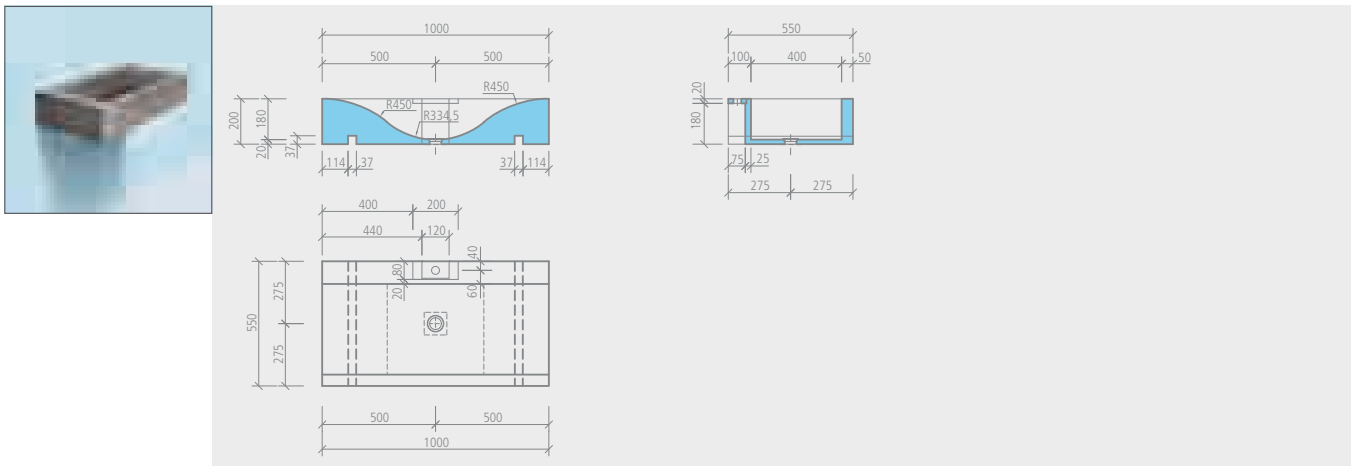

wedi Sanbath Wave ■ shower unit

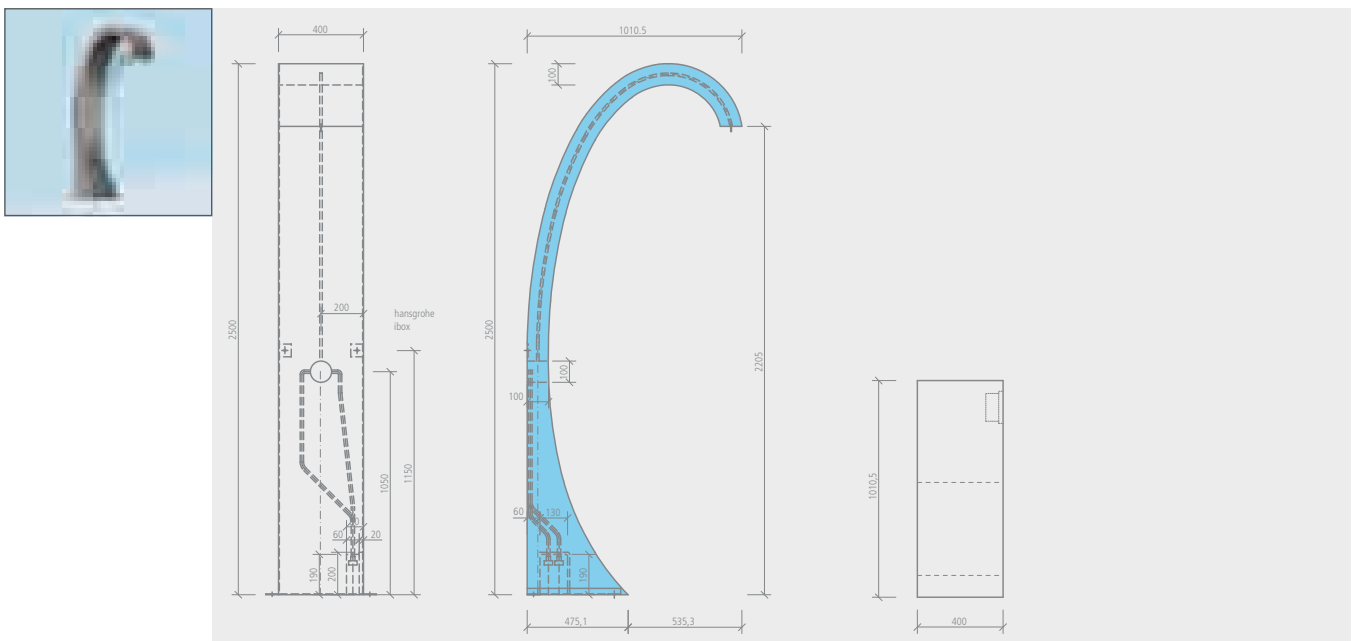

wedi Eterna ▪ glass door with stainless steel frame V₄A

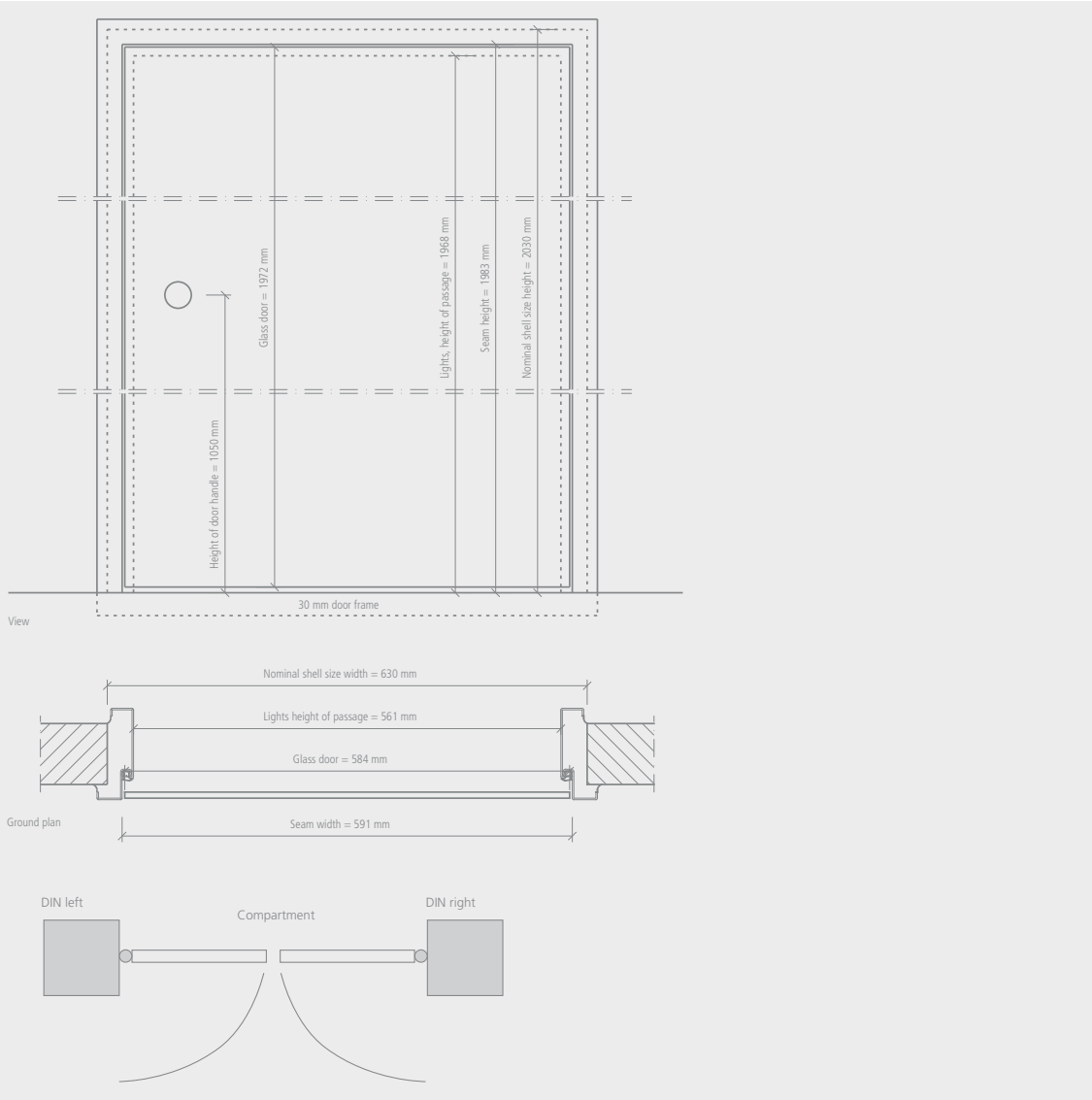
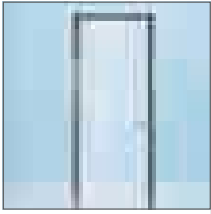

Tiling information

Maximum tile sizes for round wedi elements

Size allocation												
Radius	R 50	R 100	R 150	R 200	R 250	R 300	R 350	R 400	R 450	R 500	R 750	R 875
max. tile size	10 mm	20 mm	20 mm	20 mm	20 mm	50 mm	50 mm	50 mm	50 mm	50 mm	50 mm	100 mm

i You can find the radii of wedi products from the relevant technical drawings.

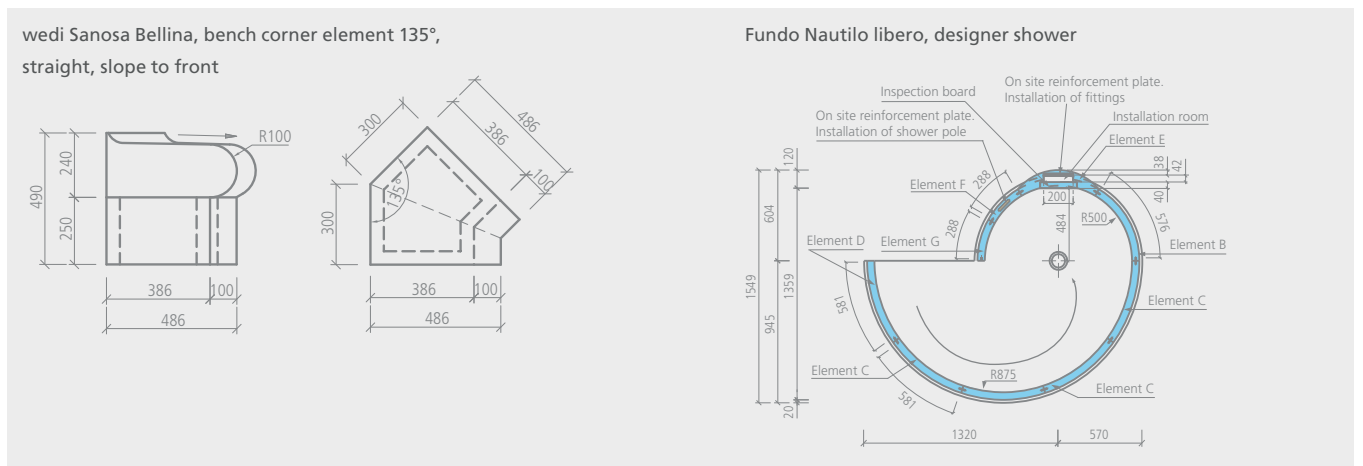

Tiling examples for the Fundo floor elements

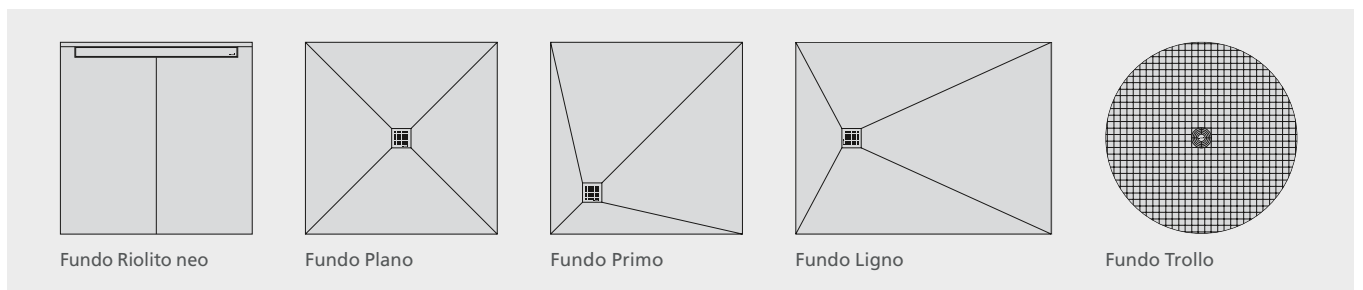

Data enquiry form for custom-made models

Customer: _____

Customer contact: _____

Construction project and address: _____

Object of enquiry:

Steam bath Multi-sensory shower (with / without Fundo)

Bathtub Special Fundo (drawing with drain position required! → Page 2)

Miscellaneous: _____

Heater positions:

Seating bench: HWH (hot-water heating) Electrical none

Walls: HWH (hot-water heating) none

Seating bench options:

Seating bench: Bellina Comoda Forma Collina Special format

Bench ends: Straight shape (coated / uncoated) Rounded edges

Bench corners: 90° corner Rounded corner

Foundation: Straight version Rounded version

Length [m]: _____ (Note: With two combined angle designs or special designs please draw a base outline on page 2!)

Foot bath: Yes No Factory-provided foundation reinforcement for shower attachments

Vapour barrier: Yes No

Ceiling options:

Flat ceiling Pitch ceiling Pointed ceiling Tunnel ceiling Dome ceiling

Ceiling coating: Textured epoxy resin coating (Can only be provided with single-part ceiling versions!) none

Door kits:

Doorframe material (stainless steel V₄A)

Folding dimension: 591 × 1983 mm 716 × 1983 mm 966 × 1983 mm

Special: _____ mm No doorframe = reinforcement in the door reveal area

Floor element for steam bath or multi-sensory shower:

Special Fundo Aluminium floor rail (only with straight walls) Floor element by the customer

wedi
INSIDE



Don't forget!

wedi doesn't just supply individual products, it also offers integrated, fully coordinated and guaranteed secure complete systems. Be it assembly, system expansion, technology or individual connections – you will always find the right solution in the wedi system.

You can find examples of this under this fold-out!

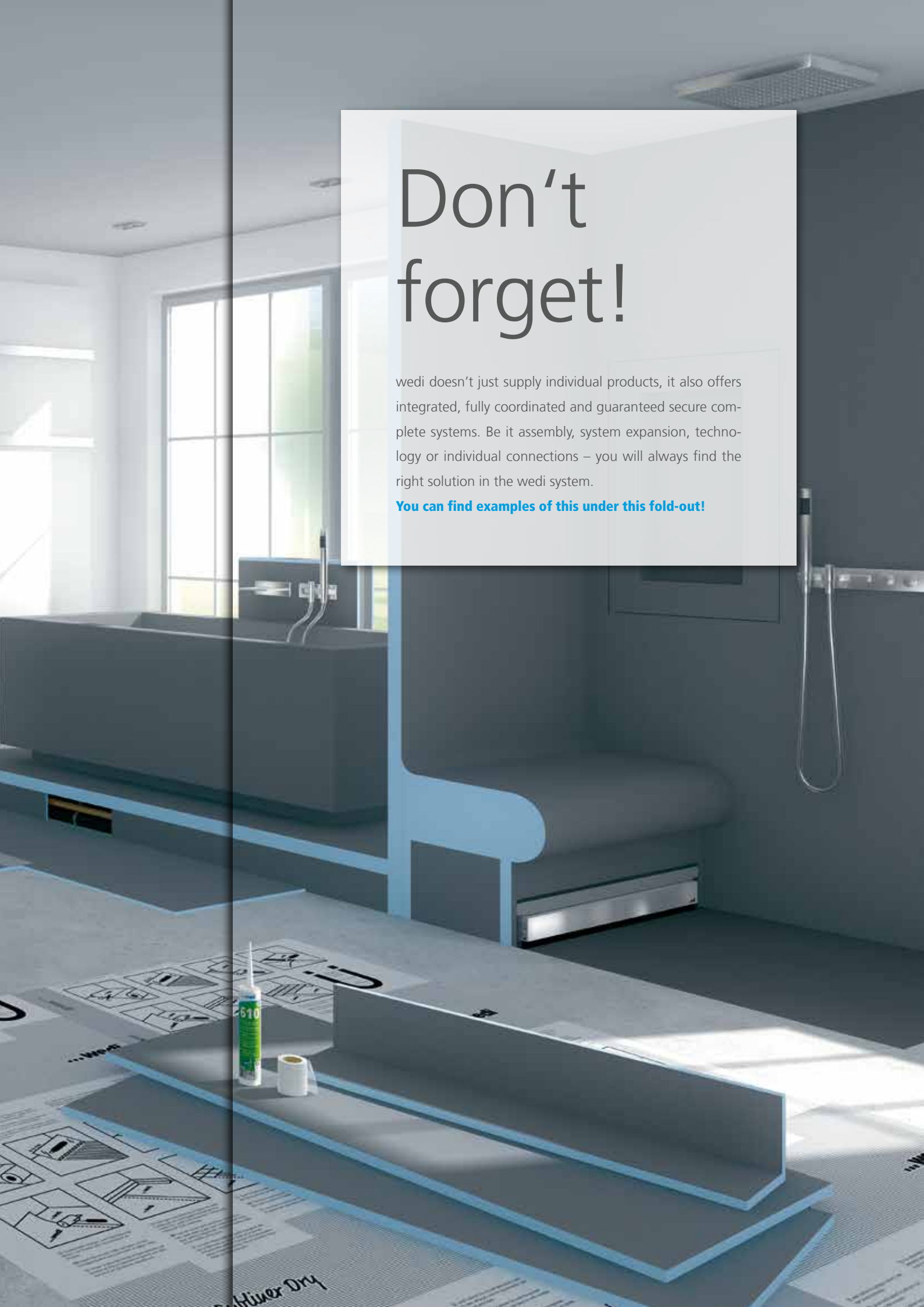

wedi
INSIDE



U
Subliver Dry



System configuration for shower elements

Compatible wedi system components

- 1 **Fundo Primo** ▪ shower element, in this case with central spot drainage ▪ from page 40
- 2 **wedi Fundo drain** ▪ in this case with an horizontal DN 50 drain including ▪ from page 47
- 3 **wedi Fundo sealing set** ▪ especially for the all-around sealing of Fundo floor elements to non-system materials such as screed ▪ from page 97
- 4 **wedi Nonstep Pro** ▪ impact sound deadening board ▪ from page 104

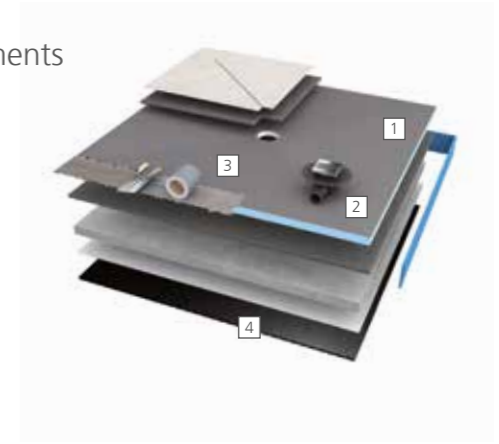

System configuration for wall and shelf solution

Compatible wedi system components

- 1 **wedi building boards** ▪ for designing wall and niche solutions on a carrier construction ▪ from page 10
- 2 **wedi 610** ▪ adhesive and sealant for the water-tight adhesion of joints and the building board on stud frames ▪ from page 22
- 3 **wedi Tools joint reinforcement tape** ▪ for reinforcing joints ▪ from page 22

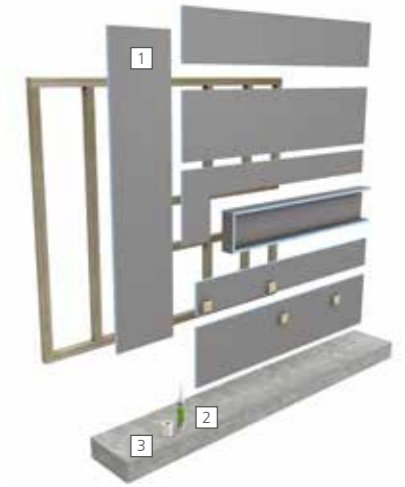

System configuration for WC solution

Compatible wedi system components

- 1 **wedi I-Board** ▪ prefabricated WC installation systems cover ▪ from page 13
- 2 **wedi building boards** ▪ for the cladding of adjoining areas ▪ from page 10
- 3 **wedi 610** ▪ adhesive and sealant for the water-tight adhesion of joints ▪ from page 22
- 4 **wedi Tools joint reinforcement tape** ▪ to reinforce joints ▪ from page 22

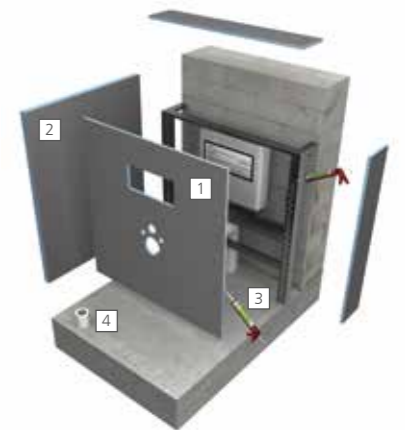

System configuration for floor construction

Compatible wedi system components

- 1 **wedi building boards** ▪ as thermally insulating flooring ▪ from page 10
- 2 **wedi 610** ▪ adhesive and sealant for the water-tight adhesion of joints ▪ from page 22
- 3 **wedi Nonstep Plan** ▪ impact sound deadening board with 14db of sound insulation under ceramic flooring ▪ from page 104
- 4 **wedi Tools joint reinforcement tape** ▪ to reinforce joints ▪ from page 22

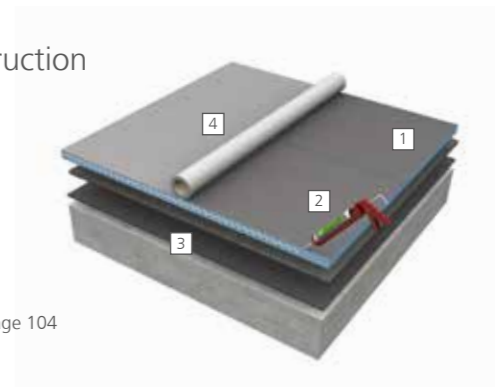



- Australia
- Austria
- Belgium
- Bosnia Herzegovina
- Canada
- Croatia
- Czech Republic

- Denmark
- Estonia
- Finland
- France
- Germany
- Great Britain
- Greece

- Hungary
- Iceland
- Ireland
- Italy
- Latvia
- Lithuania
- Luxembourg

- Netherlands
- Norway
- Poland
- Portugal
- Romania
- Russia
- Serbia

- Slovenia
- Spain
- Sweden
- Switzerland
- Turkey
- Ukraine
- USA



wedi GmbH
Hollefeldstraße 51
48282 Emsdetten
Germany

Telephone +49 2572 156-0
Fax +49 2572 156-133

info@wedi.de
www.wedi.eu

